HYSYS[®] 3.2

Simulation Basis



Copyright Notice

© 2003 Hyprotech, a subsidiary of Aspen Technology, Inc. All rights reserved.

Hyprotech is the owner of, and have vested in them, the copyright and all other intellectual property rights of a similar nature relating to their software, which includes, but is not limited to, their computer programs, user manuals and all associated documentation, whether in printed or electronic form (the "Software"), which is supplied by us or our subsidiaries to our respective customers. No copying or reproduction of the Software shall be permitted without prior written consent of Aspen Technology, Inc., Ten Canal Park, Cambridge, MA 02141, U.S.A., save to the extent permitted by law.

Hyprotech reserves the right to make changes to this document or its associated computer program without obligation to notify any person or organization. Companies, names, and data used in examples herein are fictitious unless otherwise stated.

Hyprotech does not make any representations regarding the use, or the results of use, of the Software, in terms of correctness or otherwise. The entire risk as to the results and performance of the Software is assumed by the user.

HYSYS, HYSIM, HTFS, DISTIL, and HX-NET are registered trademarks of Hyprotech.

PIPESYS is a trademark of Neotechnology Consultants.

AMSIM is a trademark of DBR & Associates.

OLI Engine is a trademark of OLI Systems Inc.

Microsoft Windows 2000, Windows XP, Visual Basic, and Excel are registered trademarks of the Microsoft Corporation.

Table of Contents

HYSYS Thermodynamics	v
1 Components	1-1
1.1 Introduction	1-2
1.2 Component List View	1-4
2 Fluid Package	2-1
2.1 Introduction	2-2
2.2 Fluid Packages Tab	2-3
2.3 Adding a Fluid Package - Example	2-4
2.4 HYSYS Fluid Package Property View	2-7
2.5 COMThermo Property View	2-70
2.6 References	2-91
3 Hypotheticals	3-1
3.1 Introduction	3-3
3.2 Hypo Manager	3-4
3.3 Adding a Hypothetical - Example	3-5
3.4 Creating a Hypo Group	3-11
3.5 Hypothetical Component Property View	3-23
3.6 Solid Hypotheticals	3-32
3.7 Cloning Library Components	3-37
3.8 Hypo Controls	3-39
3.9 References	3-40

4	HYSYS Oil Manager.....	4-1
4.1	Introduction	4-3
4.2	Oil Characterization	4-4
4.3	Petroleum Fluids Characterization Procedure	4-9
4.4	Oil Characterization View	4-13
4.5	Characterizing Assays	4-16
4.6	Hypocomponent Generation	4-51
4.7	User Property	4-66
4.8	Correlations & Installation	4-70
4.9	TBP Assay - Example	4-76
4.10	Sulfur Curve - Example	4-93
4.11	References	4-100
5	Reactions	5-1
5.1	Introduction	5-2
5.2	Reaction Component Selection	5-3
5.3	Reactions	5-6
5.4	Reaction Sets	5-32
5.5	Generalized Procedure	5-40
5.6	Reactions - Example	5-42
6	Component Maps.....	6-1
6.1	Introduction	6-2
6.2	Component Maps Tab	6-2
6.3	Component Map Property View	6-4
7	User Properties	7-1
7.1	Introduction	7-2
7.2	User Property Tab	7-3
7.3	User Property View	7-4

A	Property Methods & Calculations.....	A-1
A.1	Introduction	A-3
A.2	Selecting Property Methods.....	A-4
A.3	Property Methods	A-9
A.4	Enthalpy & Entropy Departure Calculations	A-45
A.5	Physical & Transport Properties	A-51
A.6	Volumetric Flow Rate Calculations	A-59
A.7	Flash Calculations	A-65
A.8	References	A-75
B	Petroleum Methods/Correlations	B-1
B.1	Introduction	B-2
B.2	Characterization Method.....	B-2
B.3	References	B-10
C	Amines Property Package.....	C-1
C.1	Amines Property Package	C-2
C.2	Non-Equilibrium Stage Model	C-5
C.3	Stage Efficiency	C-7
C.4	Equilibrium Solubility.....	C-9
C.5	Phase Enthalpy.....	C-18
C.6	Simulation of Amine Plant Flowsheets	C-19
C.7	Program Limitations	C-23
C.8	References	C-24
	Index.....	I-1

HYSYS Thermodynamics

To comprehend why HYSYS is such a powerful engineering simulation tool, you need look no further than its strong thermodynamic foundation. The inherent flexibility contributed through its design, combined with the unparalleled accuracy and robustness provided by its property package calculations leads to the representation of a more realistic model.

Not only can you use a wide variety of internal property packages, you can use tabular capabilities to override specific property calculations for more accuracy over a narrow range or use the functionality provided through ActiveX to interact with externally constructed property packages. Through the use of Extensibility, you can extend HYSYS so that it uses property packages that you created within the HYSYS environment.

The built-in property packages provide accurate thermodynamic, physical, and transport property predictions for hydrocarbon, non-hydrocarbon, petrochemical, and chemical fluids.

The Thermodynamics development group at Hyprotech has evaluated experimental data from the world's most respected sources. Using this experimental data, a database containing in excess of 1500 components and over 16,000 fitted binaries has been created. If a library component cannot be found within the database, a comprehensive selection of estimation methods is available for creating fully defined hypothetical components.

HYSYS also contains a powerful regression package that may be used in conjunction with its tabular capabilities. Experimental pure component data, which HYSYS provides for over 1,000 components, can be used as input to the regression package. Alternatively, you can supplement the existing data or supply a complete set of your own data. The regression package fits the input data to one of the numerous mathematical expressions available in HYSYS. This allows you to obtain simulation results for specific thermophysical properties that closely match your experimental data.

As new technology becomes available to the market place, Hyprotech welcomes the changes. HYSYS was designed with the foresight that software technology is ever-changing and that a software product must reflect these changes. HYSYS has incorporated COMThermo which is an advanced thermodynamic calculation framework based on Microsofts COM (Component Object Model) technology. The COMThermo framework is fully componentized which makes it possible to develop independent, extensible, customizable, and encapsulated thermodynamic calculation modules. It acts like a thermodynamic calculation server which allows users to utilize, supplement, or replace any of its components.

The framework also encompasses a wide variety of property calculations, flash methods, databases, etc. The calculation methods cover all of the thermodynamic calculation packages in HYSYS. In future releases of HYSYS, the old HYSYS thermodynamic engine will gradually be replaced by COMThermo.

Simulation Basis Manager

Use the Hot Key **CTRL B** to re-enter the Basis Environment from any Environment.

One of the important concepts upon which HYSYS is based is that of environments. The Basis Environment allows you to input or access information within the Simulation Basis Manager while the other areas of HYSYS are put on hold. This helps to maintain peak efficiency by avoiding unnecessary flowsheet calculations. Once you return to the Build Environment, all changes that were made in the Basis Environment take effect at the same time. Conversely, all thermodynamic data is fixed and is not changed as manipulations to the flowsheet take place in the Build Environment.

Another advantage of the Simulation Basis Environment is the assurance that all the basic thermodynamic requirements are provided before a simulation case is built. The minimum information required before leaving the Simulation Basis Manager is as follows:

- At least one installed fluid package with an attached Property Package.
- At least one component in the fluid package.
- A fluid package specified as the Default fluid package. This is automatically done by HYSYS after the first fluid package is installed.

The Simulation Basis Manager can be accessed at any stage during the development of a simulation case. When a New Case is created, the first view that appears is the Simulation Basis Manager. You can also return to the Basis Environment from the Main or Sub-Flowsheet Environment at any time to make changes to the thermodynamic information.

You can create as many fluid packages as you like in the Simulation Basis Manager. This functionality makes it possible for each flowsheet in the case to be associated with an individual fluid package, thus allowing it to have its own particular property package and set of components. The Default fluid package is assigned to each new Sub-Flowsheet that is created while in the Build Environment. If a different fluid package is desired, you can re-enter the Basis Environment to perform the required change.

Provided that changes are made in the Basis Environment, HYSYS displays a message box each time you re-enter the Main Build Environment.

If HYSYS is left in HOLDING mode, calculations can be activated by clicking the Solver Active icon in the Toolbar.

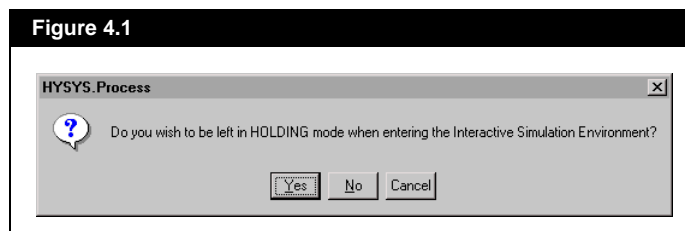

This provides a means of leaving HYSYS in HOLDING mode so that you can perform complimentary changes (i.e., new stream compositions, column specifications) to the flowsheet prior to the Basis modifications taking effect.

The Simulation Basis Manager property view allows you to create and manipulate fluid packages in the simulation. Whenever you create a New Case, HYSYS opens to the Components tab of the Simulation Basis Manager.

In this book, chapters are devoted to the explanation of each tab of the Simulation Basis manager.

Figure 4.2

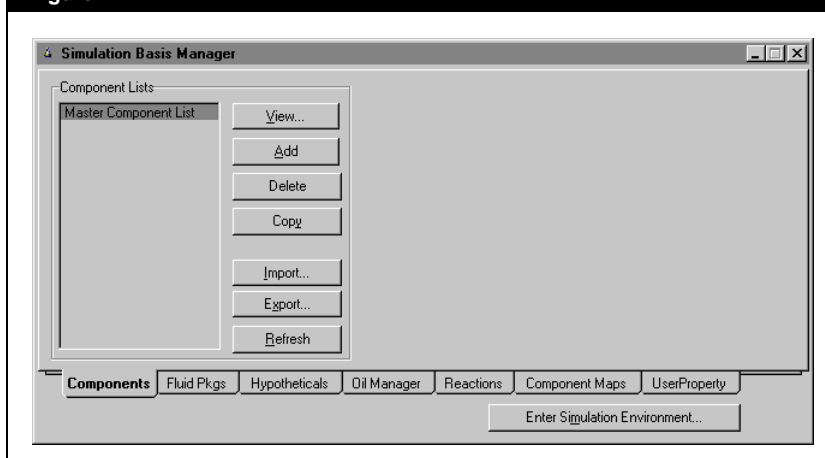

The tabs available on the Simulation Basis Manager view are described in the table below:

The Enter Simulation Environment button can be accessed from any of the tabs on the Simulation Basis Manager view.

Tab	Description
Components	Allows access to a component list which is associated with a fluid package. When adding a new component list or editing a current list, the Component List View opens. This view is designed to simplify adding components to the case.
Fluid Pkgs	Allows you to create and manipulate all fluid packages for the simulation case. Also, you can assign a fluid package to each flowsheet that exists within the case and select a Default fluid package, which is automatically used for all new flowsheets.
Hypotheticals	Allows individual Hypotheticals and Hypothetical Groups to be defined for installation into any fluid package.
Oil Manager	Allows access to the Oil Environment where you can input assay data, cut/blend an oil and define pseudo components for installation in any existing fluid package.
Reactions	Allows you to install reaction components, create reactions, create reaction sets, attach reactions to reaction sets and attach reaction sets to any existing fluid package.
Component Maps	Allows you to specify composition across fluid package (sub-flowsheet) boundaries.
User Property	Create and make user properties available to any fluid package.

1 Components

1.1 Introduction	2
1.2 Component List View	4
1.2.1 Adding Library Components.....	5
1.2.2 Selecting Library Components	8
1.2.3 Manipulating the Selected Components List	13
1.2.4 Adding Electrolyte Components	24
1.2.5 Adding Hypothetical Components	26
1.2.6 Adding Components from Existing Component Lists	27

1.1 Introduction

The Components Manager is accessed by selecting the Components tab from the Simulation Basis Manager. The Components Manager provides a location where sets of chemical components being modeled may be retrieved and manipulated. These component sets are stored in the form of Component Lists which may be a collection of library pure components or Hypothetical components.

The Components Manager always contains a Master Component List that cannot be deleted. The Master Component List contains every component available from “all” component lists. If you add components to any other Component List, they are automatically added to the Master Component List. Also, if you delete a component from the master, it is deleted from any other Component List that is using it.

Figure 1.1

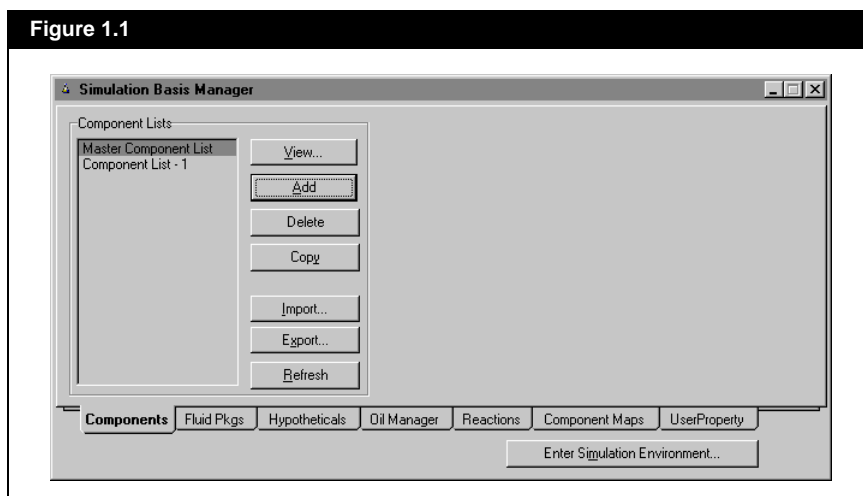

You cannot associate the Master Component List to a fluid package. Add a component list and associate it to a fluid package.

When working with the Fluid Package Manager, components are associated with Fluid Packages through Component Lists. A Component List must be selected for each Fluid Package created. For further details regarding to the use of Component Lists with Fluid Packages, see [Chapter 2 - Fluid Package](#).

The Components tab of the Simulation Basis Manager view contains six buttons which allow you to organize all component lists for the current case. Each button is described in the following table:

Button	Description
View	Opens the Component List view for the selected Component List. From this view, you can add, modify, or remove individual components from the current list.
Add	Allows you to add a new Component List into the case. When clicked, the Component List view appears and components associated with the case may be added. New components may be added to the component list by highlighting the component list name and clicking the View button.
Delete	Allows you to delete a Component List from the case. No warning message is provided before deleting a list and a deleted Component List cannot be recovered.
Copy	Makes a copy of the selected (highlighted) Component List. The copied version is identical to the original, except for the name. This command may be useful for modifying Component Lists while keeping the original list intact.
Import	Allows you to import a pre-defined Component List from a disk. When the Import button is selected, the location dialog window for the component list file appears. Component Lists have a file extension of (*.cml).
Export	Allows you to export the selected Component Lists (*.cml) to disk. The exported list file can be retrieved in another case by using the Import function detailed above.
Refresh	Allows you to reload component data from the database. For example, if you have a case from a previous version, the data is updated from the older version to the latest version.

1.2 Component List View

When adding or viewing an existing Component List from the Components tab of the Simulation Basis Manager view, the Component List View is opened.

Figure 1.2

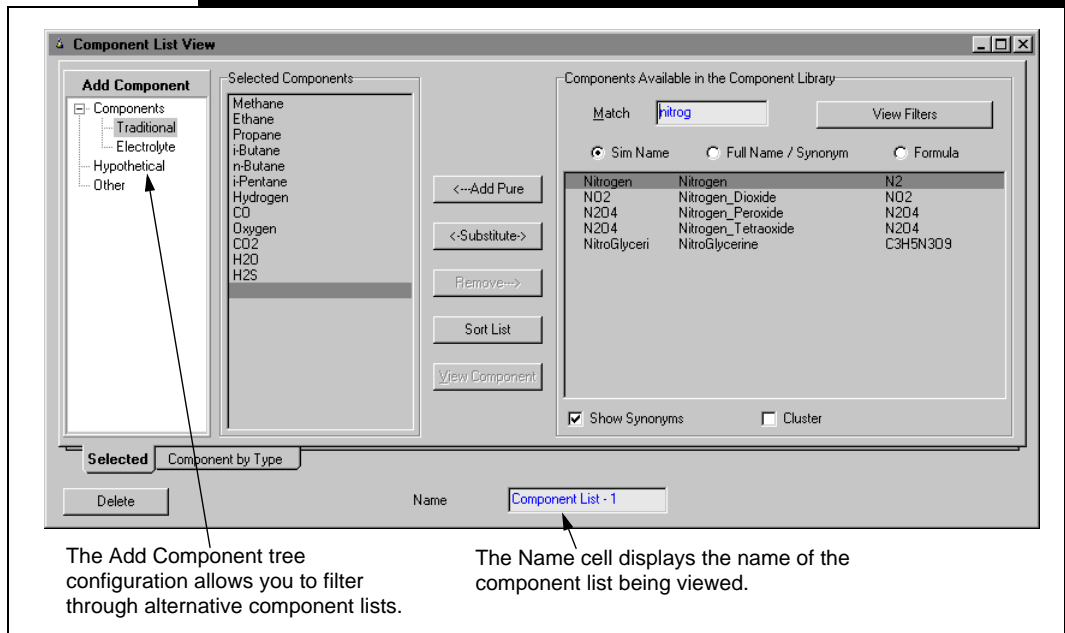

The Component List View is designed to simplify adding components to a Component List. Access is provided to all Library components within HYSYS, which include the traditional components, electrolytes, defined Hypotheticals, and other existing lists. The view consists of the following tabs:

- The Selected tab allows you to add components and view their properties. The Components page view varies according to the tree configuration selection in the Add Component group.

- The Component by Type tab displays all components selected for the component list by its particular type (traditional, electrolytes, hypotheticals, etc.) as shown below.

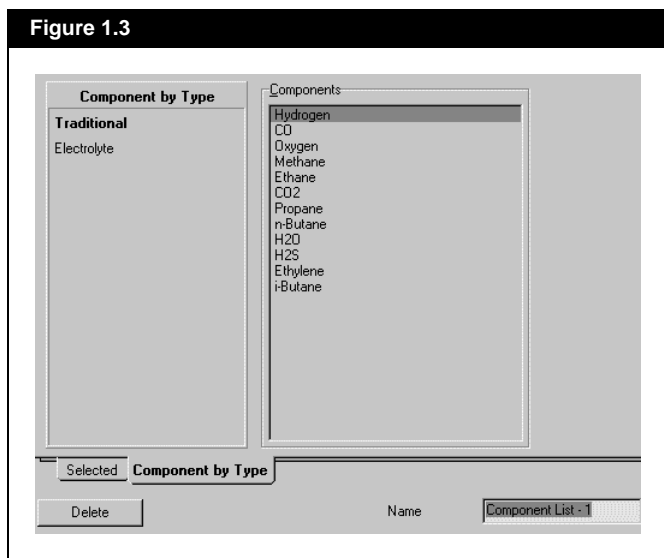

1.2.1 Adding Library Components

The Component List View shown previously is encountered when you are adding Library components to a Component List. Use the Add Components tree configuration to filter the library components for each group listed.

The Selected tab view has three main groups:

- the Add Component tree
- Selected Components group
- Components Available in the Component Library group.

Each group is described separately in the following sections.

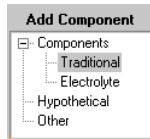

Add Component Tree

Add Component Tree

The Add Component group allows you to filter components by type. Selecting components from the component tree determines the type of components that are displayed in the Components Available in Component Library group. A different view is displayed depending on whether you are adding Traditional, Electrolytes, Hypothetical, or Other components.

Selected Components Group

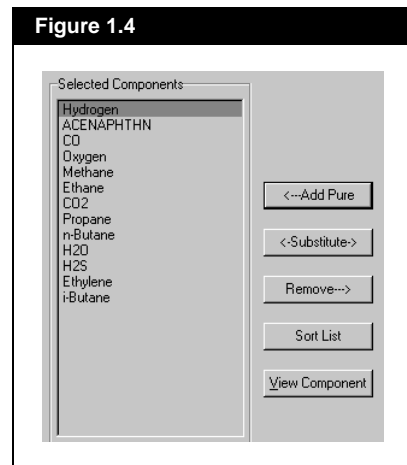

The Selected Components group shows the list of components that have been added. The various functions that allow you to manipulate the list of selected components are listed in the following table:

Object	Description
Selected Component List	Contains all the currently installed components for a particular component list.
Add Pure	Adds the highlighted component(s) from the Components Available group to the Selected Component List.
Substitute	Swaps the highlighted selected components with the highlighted available component.
Remove Comp	Deletes the highlighted component from the Selected Component List.

Object	Description
Sort List	Accesses the Move Components view, where you can change the order of the selected component list.
View Comp	Accesses the selected component's identification property view.

When substituting components, HYSYS replaces the component throughout the case (i.e., all specifications for the old component are transferred to the new component). However, the substitution function does not automatically handle components that are part of a Reaction.

Components Available in the Component Library Group

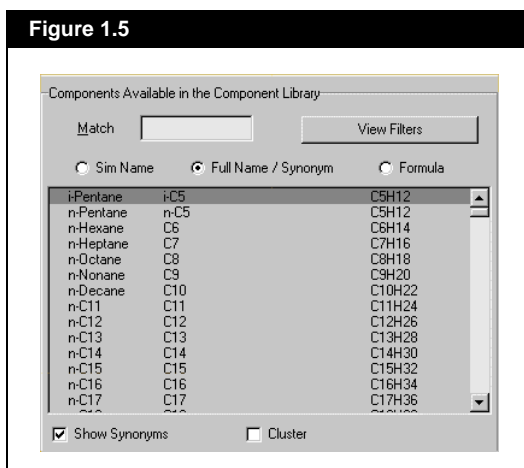

The Components Available in the Component Library group displays library components depending on the filtered method used. It has several features designed to make the selection of components as efficient and convenient as possible.

Object	Description
Match	As you type in this cell, HYSYS filters the component list to locate the component that best matches your current input. This depends on the radio button selected.
View Filter button	This button opens the Filters floating view which contains a range of property packages and component filtering options to assist in your component selection process. For further details, refer to Filter Options for Traditional Components .
SimName\ FullName Synonym\ Formula	These three radio buttons determine the context of your input in the Match cell.

Object	Description
Show Synonyms	When this checkbox is activated HYSYS includes known synonyms for each component in the list.
Cluster	This checkbox is available only when the Show Synonyms checkbox is checked. By checking the Cluster checkbox, all synonyms are indented and listed below the component name. Otherwise, the synonyms are listed alphabetically throughout the list.

1.2.2 Selecting Library Components

Whenever a component(s) is highlighted in the Available List, click the Add Pure button to move it to the Selected Component List.

As mentioned previously, library components are selected from the Components Available in the Component Library group, and placed in the Selected Components group. There are many ways in which you can select components for a component list. Once you become familiar with the available methods for component selection, you can select the procedure that you find most convenient.

The process of adding components from the component library to the Selected Components list can be divided into three sub-processes. By visualizing the process of component selection in this way, you are made aware of all the available possibilities offered by HYSYS. You can then adopt the most logical and efficient approach to use each time you build a case.

For component addition to the component list, the following methods are recommended:

1. Filter the library list.
2. Select the desired component(s).
3. Transfer the component(s) to the Selected Components list.

Filtering the Component List for Traditional Components

A recommended practice for component selection is the use of the available tools which HYSYS provides for filtering the component library. This narrows the selection range and allows you to apply one of the various methods for transferring the selection(s) to the Selected Components list.

Filtering options for electrolytes and hypotheticals are different and available in [Section 1.2.4 - Adding Electrolyte Components](#) and [Section 1.2.5 - Adding Hypothetical Components](#), respectively.

There are four tools available for filtering the list in the Components Available in the Component Library group. The filtering tools can be used independently or in combination and are described in the table below:

Filtering Tool	Description
Property Package & Family Type Filters	Filters the list according to your selection of property package and/or component families. Refer to previous Filter Options for Traditional Components for further details.
Show Synonyms	Component synonyms appear alphabetically throughout the list when this checkbox is activated.
Cluster	The Cluster checkbox is available only when the Show Synonyms checkbox is activated and Match input field is empty. By activating the Cluster checkbox, all synonyms are indented and listed below the component name.
Match	This input cell allows type-matching of the component simulation name, full name, synonym or formula.

When trying to Match a component, HYSYS searches the component column in the list for whichever radio button is selected:

Radio Button	Description
SimName	This option matches the text entered into the Match input to the name used within the simulation.
Full Name/ Synonym	This option may match the components full name or a synonym of the SimName. It is typically a longer name.
Formula	Use this option when you are not sure of the library name, but know the formula of the component.

By using the Match input cell, you can access any component within the HYSYS library that is accessible under the currently selected Property Package. You can make the Match field active by selecting it or by using the ALT M hot key.

The Match input cell accepts keyboard input, and is used by HYSYS to locate the component in the current list which best matches your input. The first character of the filtered component names must agree with first character of the listed component name. Subsequent characters in the Match cell must appear somewhere in each listed component name. Other than the first character, any number of unmatched characters can appear within the names of the listed components.

If the component you want to add is Water, type H2 in the Match cell. HYSYS filters the list of available Library Components to only those that match your current input string. The first component in the list, H2, is an exact match of your current input and therefore, is highlighted. Notice that H2O is available in the list even though you have entered only H2.

Figure 1.6

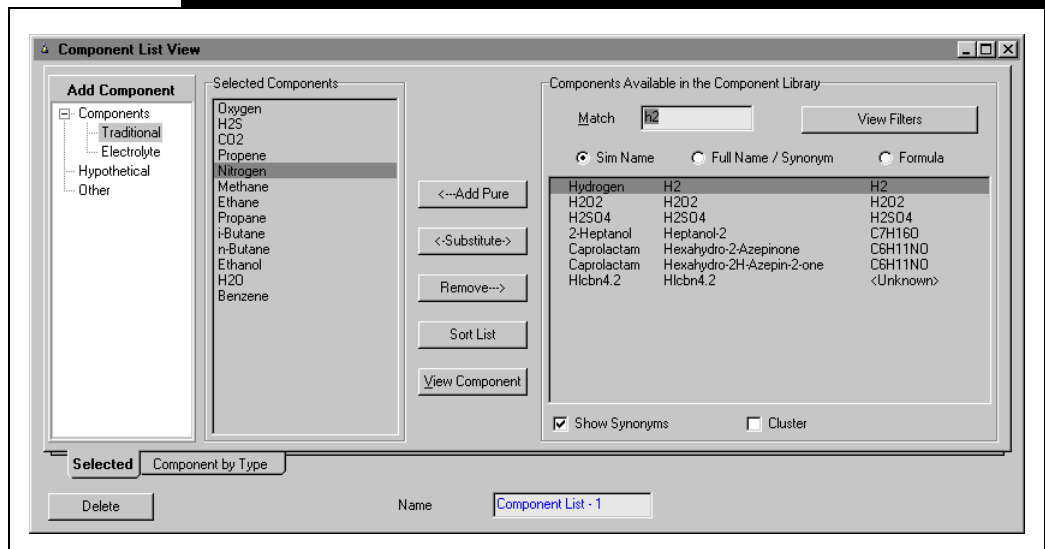

Since Hydrogen is not the component of choice, you can continue to reduce the list of available library component options by typing in the character O after the H2 in the Match cell.

Filter Options for Traditional Components

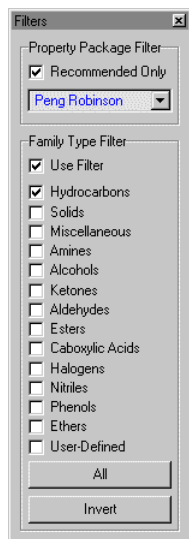

The floating Filter view is accessed by clicking the View Filters button from Component List View. It allows access to the Property Package filter and Family Type filter options.

The Property Package Filter group filters components based on their compatibility with the selected property package. Once a property package is selected, the Recommended Only checkbox works as follows:

- If the Recommended Only checkbox is selected, HYSYS only displays (in the component library list) components that are recommended with the chosen property package.
- If the Recommended Only checkbox remains un-selected, all the components in the HYSYS library are displayed in the component library list. An 'x' is shown beside each component that HYSYS does not recommend for the selected property package, however, you may still select these components if you want.

The Property Package Filter is only a component selection filtering tool and does not associate a Fluid Package with the component list (this is accomplished within the Fluid Package Manager).

The Family Type Filter group allows HYSYS to filter the list of available components to only those belonging to a specific family. The Use Filter checkbox, when selected, toggles the Family Type Filter options On and Off. By default, all checkboxes in the Family Filter group are deactivated. You can identify which families should be included in the list of available components by selecting the desired checkbox(es). The All button activates all checkboxes, and the Invert button toggles the status of each checkbox individually. For example, if you activate all of the checkboxes, and then want to quickly deactivate them, simply click the Invert button. If you only had the Hydrocarbons and the Solids options activated and you clicked the Invert button, these two options are deactivated and the remaining options are activated.

Selecting the Component(s)

After the list of Library Components are filtered, you can see the desired component among the displayed components. Use one of the following available methods to highlight the component(s) of choice described in the following table:

Selection Method	Description
Mouse	Place the cursor over the desired component and press the primary mouse button.
Keyboard	Use the TAB key or SHIFT TAB combination to move the active location into the list of components.

Whenever the list of components is filtered, the highlight is placed on the first component in the reduced list. If you use the keyboard commands to access the list of components, you may have to move the highlight if the first component is not desired.

To move through the Components Available in the Component Library group, use one of the following methods:

Method	Description
Arrow Keys	Move the highlight up or down one line in the component list.
Page Up/Page Down	Use these keyboard keys to move through the list an entire page at a time.
Home/End	The HOME key moves to the start of the list and the END key moves to the end of the list.
Scroll Bar	With the mouse, use the scroll bar to navigate through the list.

Transferring the Component(s)

After the Library Component list is filtered and the desired component(s) highlighted, transfer the selection(s) to the Selected Components list. Use one of the following methods:

- Click the **Add Pure** button
- Press the **ENTER** key
- Double-click on the highlighted item. This option only works for a single component selection.

The methods are the same whether you are adding traditional components, electrolytes, hypotheticals, or other components.

1.2.3 Manipulating the Selected Components List

After adding the components to the Selected Components list, you can substitute, remove, sort and view components. These methods apply to traditional library components, electrolytes, hypotheticals, and other components.

To demonstrate the manipulation functions, the Selected Components group shown below is used for reference purposes.

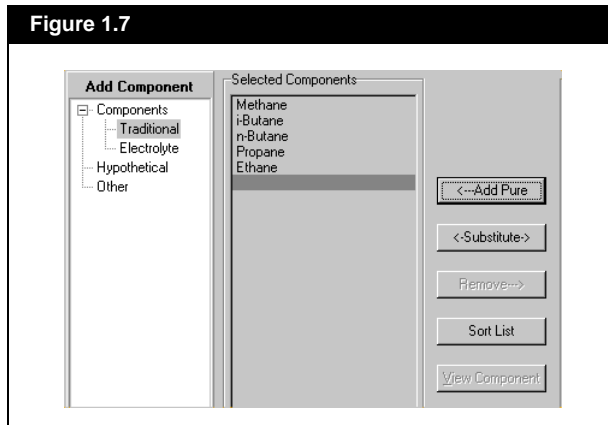

Removing Selected Components

Refer to [Chapter 3 - Hypotheticals](#) for detailed information on Hypothetical components.

You can remove any component(s) from the Selected Components list by the following steps:

1. Highlight the component(s) you want to delete.
2. Click the **Remove** button, or press the DELETE key.

For Library components, HYSYS removes the component(s) from the Selected Components list and places back in the Components Available in the Component Library list. Since Hypothetical components are shared among Fluid Packages, there is no actual transfer between the lists. (i.e., The Hypo always appears in the Available group, even when it is listed in the selected Components list.)

Substituting Components

You can only substitute one component at a time. Even though HYSYS allows you to highlight multiple components, the substitution only involves the first highlighted component.

When substituting components, HYSYS replaces the component throughout the case (i.e., all specifications for the old component are transferred to the new component). However, the substitution function does not automatically handle components which are part of a Reaction.

You can substitute a component in the selected Component List with one in the Components Available in the Component Library list by using the following procedure:

1. From the selected Component List, highlight the component you want to remove.
2. In the Available Component list, highlight the component to be substituted.
3. Click the **Substitute** button.
4. The removed component is returned to the Available Component list and the substituted component is placed in the Selected Component List.

Sorting a Component List

When there are components in the Selected Components group you can use the Sort List button to rearrange the component order.

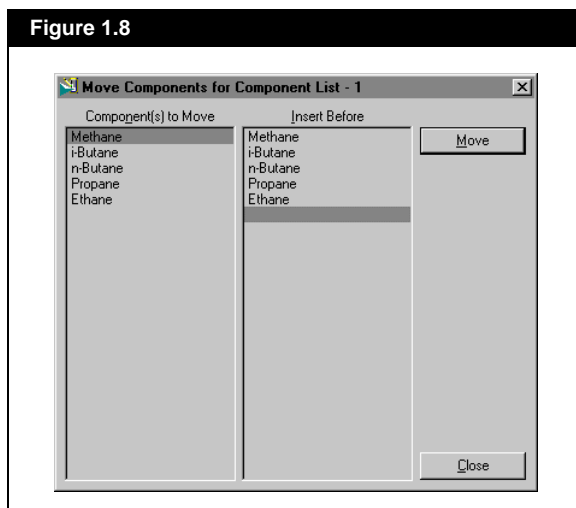

Using the view shown in [Figure 1.8](#), the sorting procedure is illustrated below:

1. Click the **Sort List** button, and the Move Components view appears.
2. From the Component(s) to Move group, select the component you want to move. In this example, **Methane** is selected.
3. From the Insert Before group, highlight the component before which Methane is to be inserted. In this case, **Propane** is highlighted.
4. Click the **Move** button to complete the move. Methane is inserted before Propane in the component list, and Ethane is forced to the top of the list, followed by Methane, Propane, and n-Butane.
5. When you have completed the sorting, click the **Close** button to return to the Components tab.

You can highlight and move multiple components.

Viewing Components

You can also examine the property view for any component in the Selected Component List by double-clicking on the component.

Once a component is added to the Selected Components list, the View Component button becomes active. The View Component button accesses the Pure Component property view allowing you to view and edit properties of the specified component.

The property views are different and are specific to the type of component selected. Pure library components and hypothetical components share the first type of property view. The difference between the two is that you cannot “directly” modify the properties in the pure components Property View, whereas, in the hypotheticals you can. The [Edit Properties](#) feature allows you to edit pure component and solid properties. For more information on hypotheticals, refer to [Chapter 3 - Hypotheticals](#).

The second property view is shared by pure component solids and hypothetical solids. Again you cannot “directly” modify the pure component solid properties, whereas, hypotheticals can be edited directly.

The electrolytes property view is the same as the edit properties feature for library components. Although, the electrolyte properties are set by OLI systems and cannot be modified like traditional components. For more information on electrolytes, refer to [Section 1.2.4 - Adding Electrolyte Components](#).

Each view consists of five tabs. Throughout the tabs the information is displayed in red, blue and black. Values displayed in red are estimated by HYSYS. Values displayed in blue are user supplied. Black values represent calculated values or information that is provided by HYSYS.

Pure Component Property View

You can also view a component by right-clicking on it and selecting View.

In this example, Methane and Carbon are used by clicking the View Component button, which opens the following traditional pure component and Solid pure component property views, respectively:

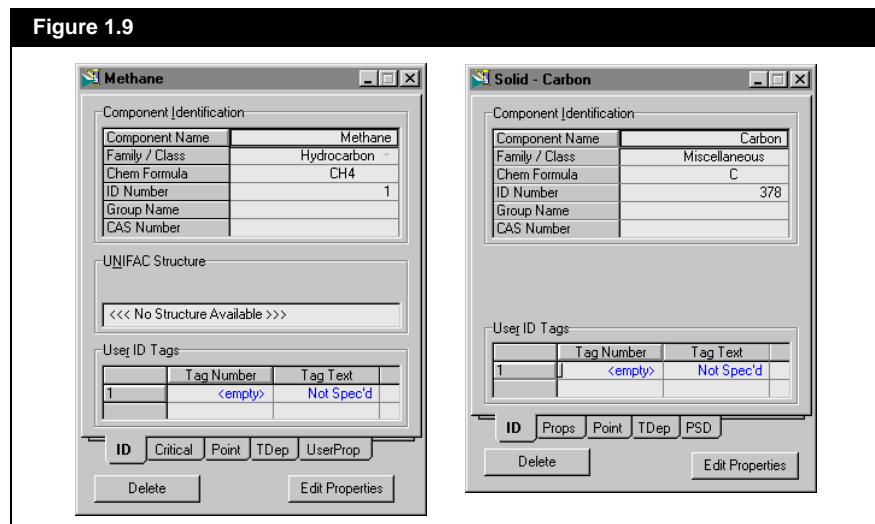

ID Tab

The ID tab is the first tab in the property view. The black values in the Component Identification group represent information that is provided by HYSYS. The User ID Tags are used to identify your component by a user specified tag number. You can assign multiple tag numbers to each component.

Critical Tab & Props Tab

The Critical Tab displays Base and Critical Properties. The properties for pure components are supplied by HYSYS and are read-only. However, you can edit these properties using the [Edit Properties](#) button.

The Component Property view for solid components does not have critical properties and therefore does not require the Critical tab. An alternate tab called the Props tab which displays default values for Solid properties and Coal Analysis is included. These properties can also be edited using the Edit Properties button.

Point Tab

Additional Point properties are given by HYSYS for the Thermodynamic and Physical Props and the Property Package Molecular Props. The pure component properties differ from the solid properties.

The solid properties depend only on the Heat of Formation and Combustion. These properties may be altered by selecting Point properties in the Edit Properties view.

TDep Tab

The temperature Dependent Properties for pure components are shown in this tab. HYSYS provides the minimum temperature, maximum temperature and coefficients for each of the three calculation methods.

The difference between pure components and solid pure components is that solids do not participate in VLE calculations. Their vapour pressure information is, by default, set to zero. However, since solid components do affect Heat Balances, the Specific Heat information is used. The properties may be edited by selecting the Edit Properties button.

UserProp & PSD Tabs

See [Chapter 7 - User Properties](#) for more information.

The UserProp tab displays user specified properties. User properties must be specified on the UserProperty tab in the Simulation Basis Manager view. Once a user property is specified there, you can view and edit UserProp on this component view.

The PSD tab displays the particle size distribution for solids. It allows the user to specify PSDs and calculate various mean and modal diameters for the entered PSD.

To edit a PSD, click the Edit Properties button to open the Editing Properties for Component view, select Type radio button in the Sort By group, and select Particle Size Distribution from the tree browser. The options available for edit the PSD appears on the right side of the Editing Properties for Component view.

Figure 1.10

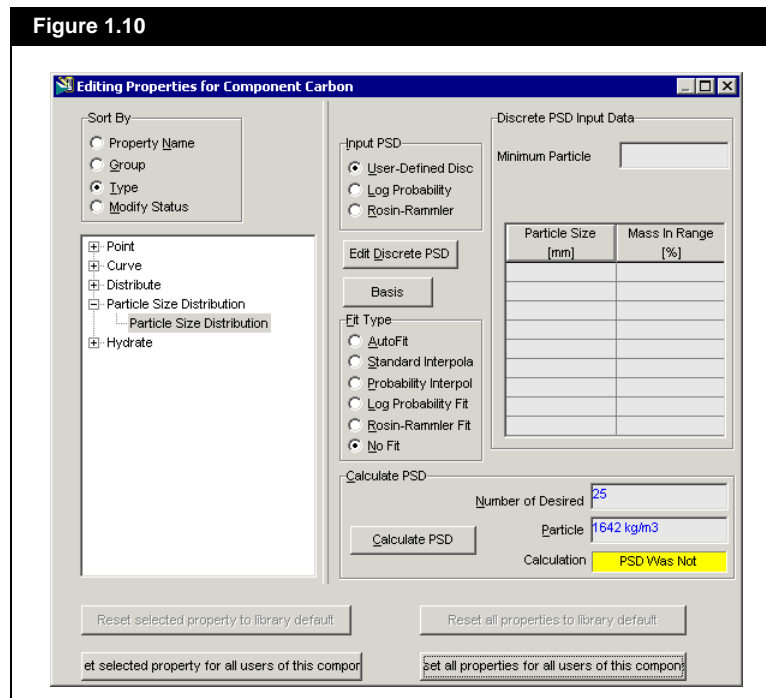

A PSD can be specified in three ways:

Input PSD Group	Description
User-Defined Discrete	Allows the user to enter particle diameter vs distribution values over the range of the distribution. To enter the distribution, Select the Edit Discrete PSD button. The entered distribution can be a Composition Basis with mass percent or number percent data and can be InSize, cumulative Undersize or cumulative Oversize as an Input Basis. Once a discretized PSD is entered, the user can have other types of PSD fitted to it. These fits are displayed in the Fit Type group. The selected fit can be changed by regenerating the fit at any time.
Log-probability	Is a two-parameter statistical representation which allows the user to specify the mean and standard deviation of the PSD.
Rosin-Rammler	Is a two-parameter statistical representation which allows the user to specify the Rosin-Rammler model diameter and spread parameter of the PSD.

The input information required for each Input PSD are as follows:

Input PSD Group	Input Information Required
User-Defined Discrete	The PSD requires PSD name, basis, particle density and number of points to use in fitted PSDs. The distribution requires particle diameters (including minimum diameter) and either InSize, Undersize or Oversize distribution points.
Log-probability	The PSD requires PSD name, basis, particle density and number of points to use in generating the PSD. The distribution requires mean diameter and standard deviation.
Rosin-Rammler	The PSD requires PSD name, basis, particle density and number of points to use in generating the PSD. The distribution requires modal diameter and spread parameter.

The user has the choice between using the User-Defined Discrete or one of the statistical distribution methods. The statistical methods (Log Probability & Rosin-Rammler) may be preferred over the discrete method if any of the following occurs:

- A number of particle size measurement devices give the distribution as a statistical fit.
- Certain physical process tend to give rise to distributions that are described well by a statistical distribution. For example, processes involving high shear (e.g. crushing of coal, atomization of liquids in a two-fluid nozzle) tend to give size distributions that can be readily described by a Rosin-Rammler distribution.
- By using a statistical distribution, it is easier to extend the distribution to lower and higher size ranges. For many design processes involving size distributions, it is the values of the distribution at these 'tails' that have most influence when trying to optimize the design. Therefore, the accuracy with which these 'tails' can be described is important.

The Fit Type group for the User-Defined Discrete Input allows users to fit a distribution to the entered discrete data. The fitting improves the accuracy of any calculations made by it.

- It increases the number of discrete steps over which a size distribution can be described. The more steps, mean smaller steps which means more accuracy when interpolating, etc.
- It provides more data at the extremes ('tails') of the distribution, again improving accuracy.

The fit type used is based on which provides the closest fit to the data. The fitting algorithm displays a dialog with six fits to the data. The AutoFit selects one fit for the data automatically, and the NoFit does not fit the data. The Standard and Probability fit types are lagrangian interpolations on the entered data, but one works on the raw data while one works on a probability transformation of the data. That is, the distribution values are transformed to the linear equivalents used in plotting against a probability axis.

The other two fits are a log-probability and a Rosin-Rammler distribution. For these two fits, the value of R^2 (the fit coefficient) is given and the closer this is to 1 the better the fit. Ultimately, it is up to the user to choose the best fit and is often based on the visual appearance of the fitted distributions compared to the entered one. One limitation to PSD is that the particle diameters cannot be specified as sieve mesh sizes.

Edit Properties

The Edit Properties button allows the user the flexibility of viewing and modifying properties for traditional and hypothetical components. Electrolyte component properties are specified by OLI Systems which may only be viewed. The Edit Properties View can be accessed on three different levels and are shown below:

- **Component level.** Double-click on any component or right-click and select View. Click the Edit Properties button.
- **Fluid Package level.** Click the Edit Properties button on the Fluid Package view.
- **Stream level.** Select a stream which is not a product stream. Click the Edit Properties button on the Composition page.

The Component level Edit Properties view is shown below for methane.

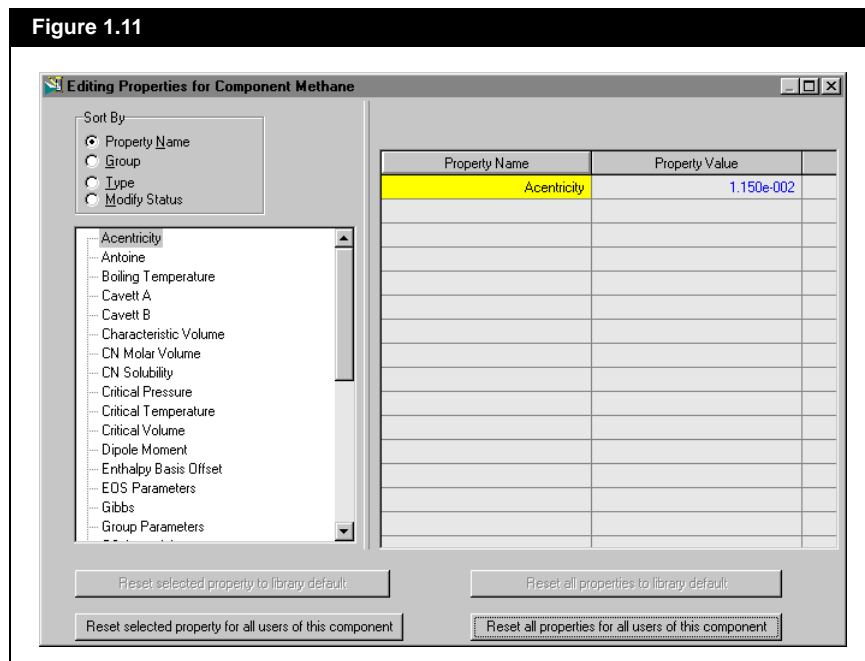

The properties can be sorted using the Sort By group on any level.

Sort By	Description
Property Name	Sort through properties by Property Name.
Group	Sort through properties by Groups. This includes Thermo, Prop Pkg, Physical, Cold, Solid, etc.
Type	Sort through Point, Curve, Distribute, PSD, and Hydrate properties.
Modify Status	Sort through properties which are modified in the specific Component, Fluid Pkg, or Stream.

The edit Properties feature is flexible in that it allows you to edit properties on the component, fluid package, or stream levels. The component level is the highest and allows you to edit properties throughout your case. Any changes at this level correspond to a global change to all fluid packages using the particular component. The initial value stored at this level for any given component is considered the 'default' property value.

At the component level, the reset options are described below.

Component Level Reset	Description
Reset selected property to library default	Resets the selected property to the library or original default value for this component. This button is active only if a component is modified on the component level.
Reset all properties to library default	Resets all properties to library or original default values for this component. This button is active only if a component is modified on the component level.
Reset selected property for all users of this component	Clears local changes to the selected property for all users of this component. Users are defined by changes in the Fluid pkg and stream levels.
Reset all properties for all users of this component	Clears local changes to all properties for all users of this component. Users are defined by changes in the Fluid pkg and stream levels.

The second level is the fluid package level which allows you to edit properties specific to a fluid package. This allows the flexibility of having different property values for different fluid packages throughout the case. Any changes at this level corresponds to a change for any flowsheet using this fluid package. The reset options for the fluid pkg level are described below:

Fluid Pkg Level Reset	Description
Reset selected prop vector to components default	Clears the selected property vector within this fluid package and resets it to the component level value.
Reset all props to components default	Clears all changed property vectors within this fluid package and resets them to the component level values.
Reset selected property for all users of this fp	Clears local changes to selected property vector for all users of this fluid package. The user is defined as the stream level property selected, which is overwritten with current fluid package value.
Reset all properties for all users of this fp	Clears local changes to all properties for all users of this fluid package. The users are defined as the stream level properties, which are overwritten with current fluid package values.

The stream level allows you to edit properties specific to input streams of the case. Changes made at this level enable one to modify a particular component's property for a particular stream. This allows the flexibility of properties to dynamically change across the flowsheet.

The reset options are listed below and are active if you modify a property value at the stream level.

Stream Level Reset	Description
Reset Selected Prop Vector to FP Default	Clears selected property vector and reset it to the fluid package level value for this stream.
Reset All Props to FP Default	Clears all changed property vectors and reset them to the fluid package values for this stream.

The properties for the stream are accessible from the stream level editor. However, only the feed stream properties are modifiable.

Keep in mind that any property vector changes at the Stream level supercede changes at the fluid package level. For example, if a stream is trying to access a particular component's 'Point' property value and the property vector is contained in the stream's local property slate, the local value is used. If the property vector does not exist locally, then it calls up to the fluid package's property state for the particular property vector and uses this value if it exists. If the property vector does not exist at the fluid package level, then the initial Component level value is used.

1.2.4 Adding Electrolyte Components

Electrolytes can be added to the component list in the Component List View. In the Add Component group of the Selected tab, select the Electrolyte page located as the subgroup of the Components configuration.

The view is filled with information on electrolytes as shown below.

Figure 1.12

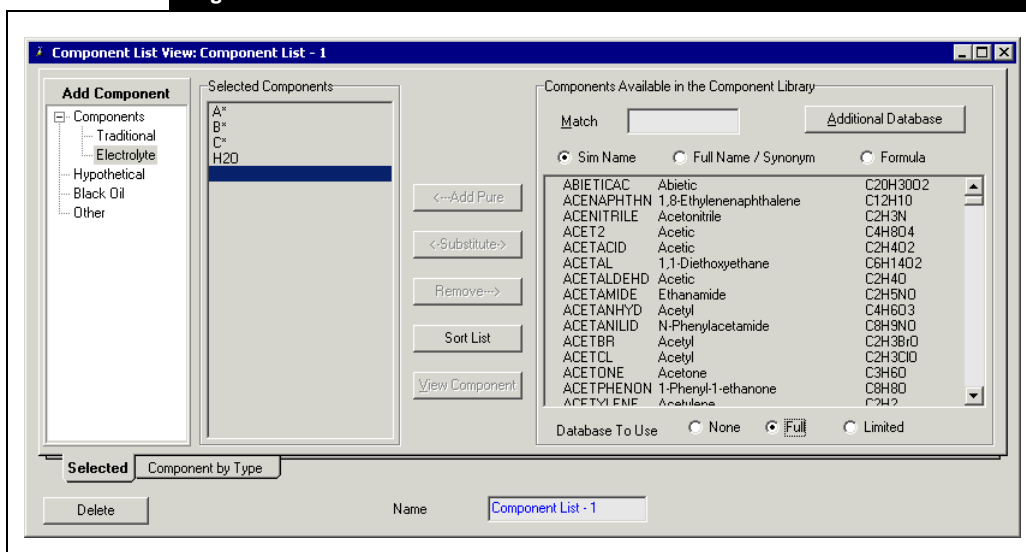

The methods for adding, substituting, removing, and sorting components are common for all components on the selected tab. The filtering options for Electrolytes which are described in the following table:

Filter	Description
Match	This input cell allows type-matching of the component simulation name, full name / synonym, or formula based on the ratio button selected.
None	No electrolyte components exist or match your selection in the view. You need to acquire an additional license to view the electrolyte database.

Refer to [Filtering the Component List for Traditional Components](#) for additional information on using the Match field to filter the component list for traditional components.

Filter	Description
Full	The full database contains thousands of species in water based on the OLI system database.
Limited	This database contains approximately 1,000 components which are of most interest to process industries.

Refer to the following sections in the **HYSYS OLI Interface Guide** for more information on the OLI databases:

- [Section 1.8.1 - Full Database](#)
- [Section 1.8.2 - Limited Database](#)
- [Section 1.8.3 - Special Databases](#)
- [Section 1.8.4 - Private User Databases - OLI Data Service](#)

You can select or provide additional electrolyte component databases to simulate special aqueous-based chemical systems. HYSYS supports three special databases: **GEOCHEM**, **LOWTEMP**, and **REDOX**. You can access those special databases by clicking on the Additional Database button, and select the desired special databases from the Special Databank group in the OLI_Electrolyte Additional Database view. The use of GEOCHEM, LOWTEMP, and REDOX databases must combine with the choice of Full Databank. You can also supply your own OLI private databank to suit the need of your simulation case.

To get a comprehensive list of the Full, and GEOCHEM database components, refer to [Appendix A.1 - Listing of the Full HYSYS OLI Interface Database](#) and [Appendix B.1 - Listing of the HYSYS OLI Interface GEOCHEM Database](#), of the HYSYS OLI Interface Reference Guide.

1.2.5 Adding Hypothetical Components

Refer to [Section 3.5 - Hypothetical Component Property View](#) for details on the various Component property view tabs.

Hypotheticals can be added to a component list through the Components List View. In the Add Components group of the Selected tab, select the Hypothetical page from the tree configuration list. The Components List View is filled with information appropriate to the addition of Hypothetical components.

Figure 1.13

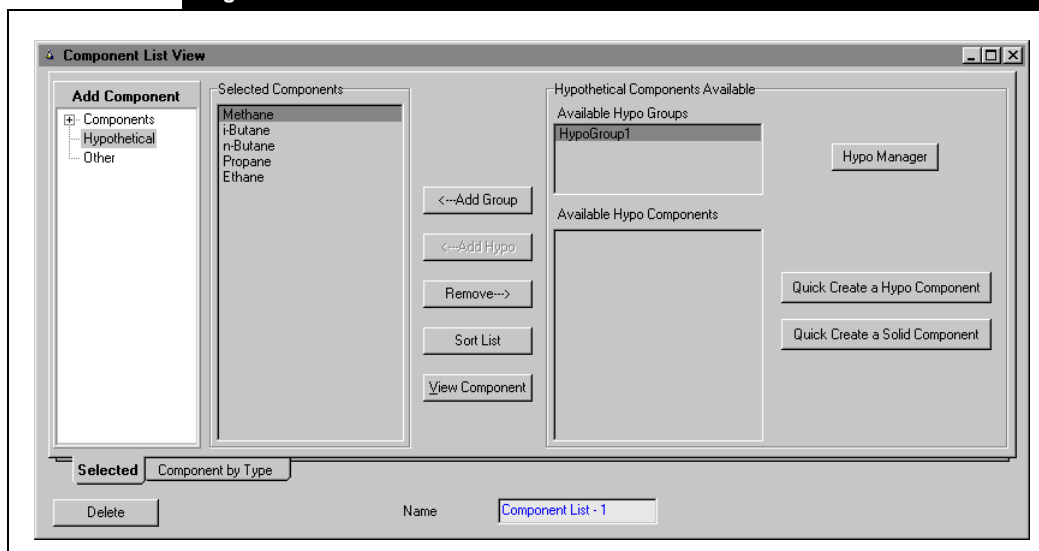

Refer to [Chapter 3 - Hypotheticals](#) for more detailed information to Add and modify Hypothetical components.

Some of the features from the Selected tab are common to both the selection of Hypotheticals and Library components. Items specific to Hypotheticals are described in the following table:

Object	Description
Add Group	Adds all the Hypothetical components in the Selected selection in the Hypo Group list current to the current component list.
Add Hypo	Adds the currently selected Hypothetical in the Hypo Component list to the Current Component List.
Hypo Group	Displays all the Hypo Groups available to the current component list.
Hypo Components	Displays all the Hypothetical components contained in the currently selected Hypo Group.
Hypo Manager	Accesses the Hypotheticals tab of the Simulation Basis Manager, from which you can create, view, or edit Hypotheticals.

Object	Description
Quick Create a Hypo Comp	A short-cut for creating a regular Hypothetical component and adds it to the currently selected Hypo Group and opens its property view.
Quick Create a Solid Hypo component	A short-cut for creating a solid Hypothetical component and adds it to the currently selected Hypo Group and opens its property view.

While you can add Hypos to a Component List from the Selected tab, this is merely a short-cut. To access all features during the creation of Hypotheticals and Hypothetical groups, you should access the Hypotheticals tab of the Simulation Basis Manager.

1.2.6 Adding Components from Existing Component Lists

Components can be added from other component lists by using the Other List option. In the Add Components group, select the Other list. The Components tab is redrawn with information appropriate to accessing components from alternate component lists.

Figure 1.14

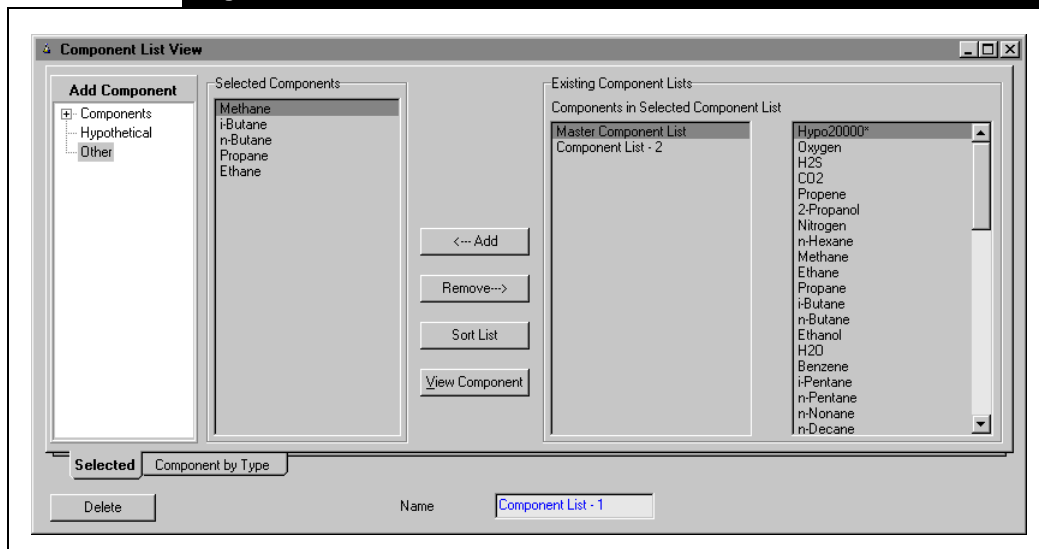

The Existing Components group displays a list of all available component lists loaded into the current case. Highlighting a component list name displays its associated group of components in the Components in Selected Component List.

To transfer a component from an existing component list, simply highlight the component name in the list and click the Add button. The highlighted component is added to the Selected Components list.

2 Fluid Package

2.1 Introduction	2
2.2 Fluid Packages Tab	3
2.3 Adding a Fluid Package - Example	4
2.4 HYSYS Fluid Package Property View	7
2.4.1 Set Up Tab.....	7
2.4.2 Parameters Tab	20
2.4.3 Binary Coefficients Tab.....	32
2.4.4 Stability Test Tab	40
2.4.5 Phase Order Tab	44
2.4.6 Reactions Tab.....	46
2.4.7 Tabular Tab.....	47
2.4.8 Notes Tab	69
2.5 COMThermo Property View	70
2.5.1 Set Up Tab.....	71
2.5.2 Parameters Tab	82
2.5.3 Binary Coefficients Tab.....	84
2.5.4 Stability Test Tab	87
2.6 References	91

2.1 Introduction

In HYSYS, all necessary information pertaining to pure component flash and physical property calculations is contained within the Fluid Package. This approach allows you to define all the required information inside a single entity. There are four key advantages to this approach and are listed below:

- All associated information is defined in a single location, allowing for easy creation and modification of the information.
- Fluid Packages can be exported and imported as completely defined packages for use in any simulation.
- Fluid Packages can be cloned, which simplifies the task of making small changes to a complex Fluid Package.
- Multiple Fluid Packages can be used in the same simulation; however, they are all defined inside the common Simulation Basis Manager.

In this chapter, all information concerning the fluid package are covered. This includes the basic procedure for creating a fluid package by using both traditional HYSYS and COMThermo thermodynamics. Finally, information on the Fluid Package property view is provided for each of the following tabs:

- Set Up
- Parameters
- Binary Coefficients
- Stability Test
- Phase Order
- Reactions (Rxns)
- Tabular
- Notes

It should be noted that individual components are not added within the Fluid Package Manager. Instead, component selection is handled independently in the Basis Manager through the Components tab. The Components Manager provides a general location where sets of chemical components being modeled may be retrieved and manipulated.

Refer to [Chapter 1 - Components](#) for further details on the Components Manager.

2.2 Fluid Packages Tab

You must define at least one fluid package prior to entering the Simulation Environment.

The next tab of the Simulation Basis Manager view is the Fluid Packages (Fluid Pkgs) tab. When you create a New Case, HYSYS displays the Fluid Pkgs tab, as shown below:

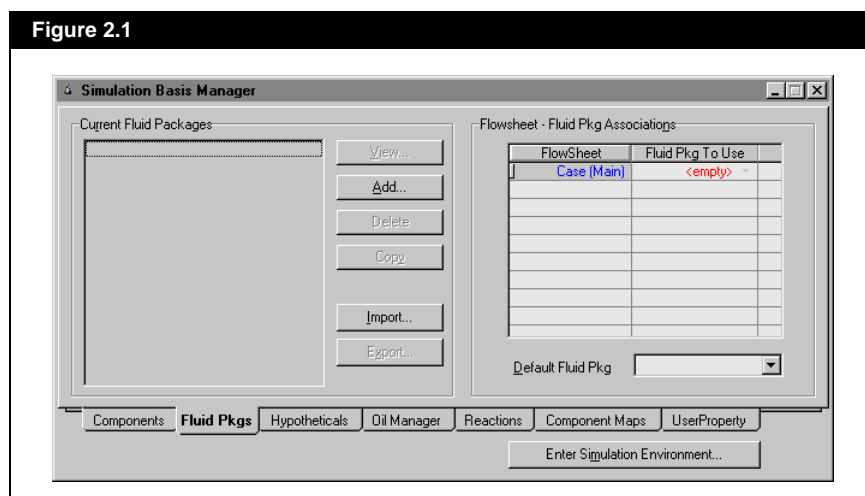

When a New Case is created, only the Add and Import buttons are available.

In the Current Fluid Packages group, there are six buttons that allow you to organize all Fluid Packages for the current case and are described below:

Refer to [Section 2.4 - HYSYS Fluid Package Property View](#) for details on what information you can edit by clicking the View button.

For details concerning the importing and exporting functionality, refer to [Section 7.24.7 - Exporting/Importing Workbook Tabs](#) in the User Guide.

Button	Description
View	This is only active when a fluid package exists in the case. It allows you access the property view for the selected fluid package.
Add	Allows you to install a new fluid package into the case.
Delete	Allows you to delete a fluid package from the case. When you delete a fluid package, HYSYS displays a warning, and asks you to verify that you want to delete the package. You must have at least one fluid package for your case at all times.
Copy	Makes a copy of the selected fluid package. Everything is identical in this copied version, except the name. This is a useful tool for modifying fluid packages.
Import	Allows you to import a pre-defined fluid package from disk. Fluid packages have the file extension .fpk .
Export	Allows you to export the selected fluid package (*.fpk) to disk. The exported fluid package can be retrieved into another case, by using its Import function.

Changing the default package only changes those fluid pkgs that are currently set to use the default fluid package. That is, any operation or stream which is not set to the default fluid package is not modified.

Refer to [Chapter 12 - Logical Operations](#) in the Operations Guide for detailed information on the stream cutter object and fluid package transitioning.

The Flowsheet - Fluid Pkg Associations group lists each Flowsheet in the current simulation along with its associated Fluid Package. You can change the associations between Flowsheets and which Fluid Pkg To Use in this location. You can also specify a default fluid package by selecting a package in the Default Fluid Pkg drop-down list. HYSYS automatically assigns the Default Fluid Package to each unit operation, SubFlowsheet or columns using the default fluid package in the simulation. Selecting an alternative fluid package from the Basis Manager view allows you to transition or switch between fluid pkgs anywhere in the flowsheet with the addition of the stream cutter object.

2.3 Adding a Fluid Package - Example

When you click the Add button from the Simulation Basis Manager view, HYSYS opens the Fluid Package property view to the Set Up tab. The Fluid Package view is based on the traditional HYSYS Thermodynamics.

Figure 2.2

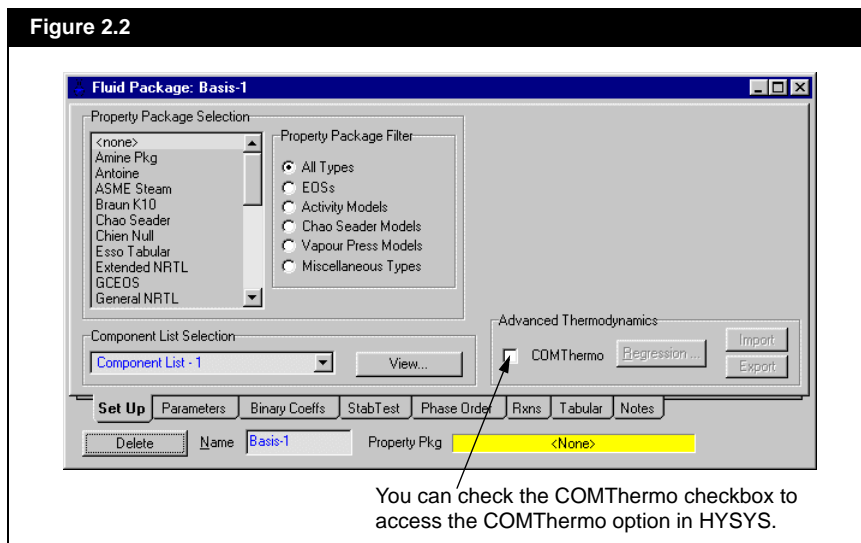

You can check the COMThermo checkbox to access the COMThermo option in HYSYS.

A complete description of each page of the Fluid Package property view is given in [Section 2.4 - HYSYS Fluid Package Property View](#).

For further details relating to Component Lists and component selection, refer to [Chapter 1 - Components](#).

Refer to [Chapter 5 - Reactions](#) for information on the Reaction Manager.

The order of the tabs in the Fluid Package property view are tied to the sequence of defining a Fluid Package using HYSYS thermodynamics.

- On the Set Up tab, select a Property Package for the case from the Property Package Selection group. You can filter the list of Property Packages by selecting a radio button in the Property Package Filter group. You must also select a Component List for the case from the Component List Selection group. Component Lists are built in the Simulation Basis Manager and may contain library, hypothetical, and electrolyte components.
- Depending on the Property Package selected, you may need to specify additional information, such as the Enthalpy and Vapour Model, Poynting Correction factor, etc.
- Depending on the Property Package selected you may need to supply additional information based on the selected components. This is done on the Parameters tab.
- If necessary, specify the binary coefficients on the Binary Coeffs tab. As an alternative to supplying binaries, you may want to have estimates made for the selected components.
- If necessary, instruct HYSYS how to perform Phase Stability tests as part of the flash calculations on the Stab Test tab.
- Define any reactions and reaction sets for the fluid package or access the Reaction Manager on the Rxns tab.
- On the Tabular tab, you can access the Tabular Package for the equation based representation of targeted properties.
- The final tab on the Fluid Package property view is the Notes tab, where you can supply descriptive notes for the new Fluid Package.

If you click the COMThermo checkbox in the Advanced Thermodynamics group, HYSYS opens the Fluid package property view to the Set Up tab. The Fluid Package view is based on the COMThermodynamics framework.

Figure 2.3

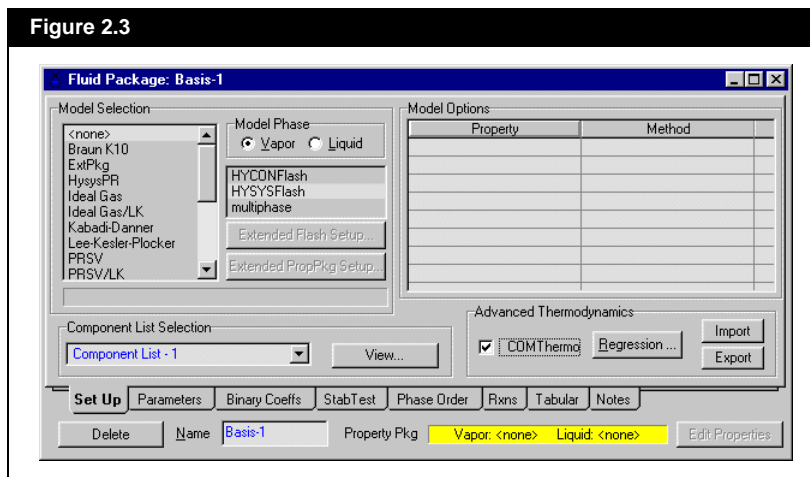

The order of the tabs in the Fluid Package property view are similar to the traditional HYSYS Thermodynamics as above except for the following:

- On the Set Up tab, select a model case from the Model Selection group for the vapor and liquid phase.
- Depending on the model selected, you may specify additional information. For example, in the Model Options group select the calculation methods for Enthalpy and Entropy, C_p , etc., using the drop-down list.
- Depending on the Model selected, you may need to supply additional information based on the selected components. This is done on the Parameters tab.
- If necessary, specify the binary coefficients on the Binary Coeff tab. As an alternative to supplying binaries, you may want to have estimates made for the selected components.
- If necessary, instruct HYSYS-COMThermo how to perform Phase Stability tests as part of the flash calculations on the Stab Test tab.

2.4 HYSYS Fluid Package Property View

Refer to [Section 2.5 - COMThermo Property View](#) for more information on Advanced Thermodynamics.

The Fluid Package property view consists of eight tabs and is based on the traditional HYSYS thermodynamics. Among these tabs is all the information pertaining to the particular Fluid Package.

Figure 2.4

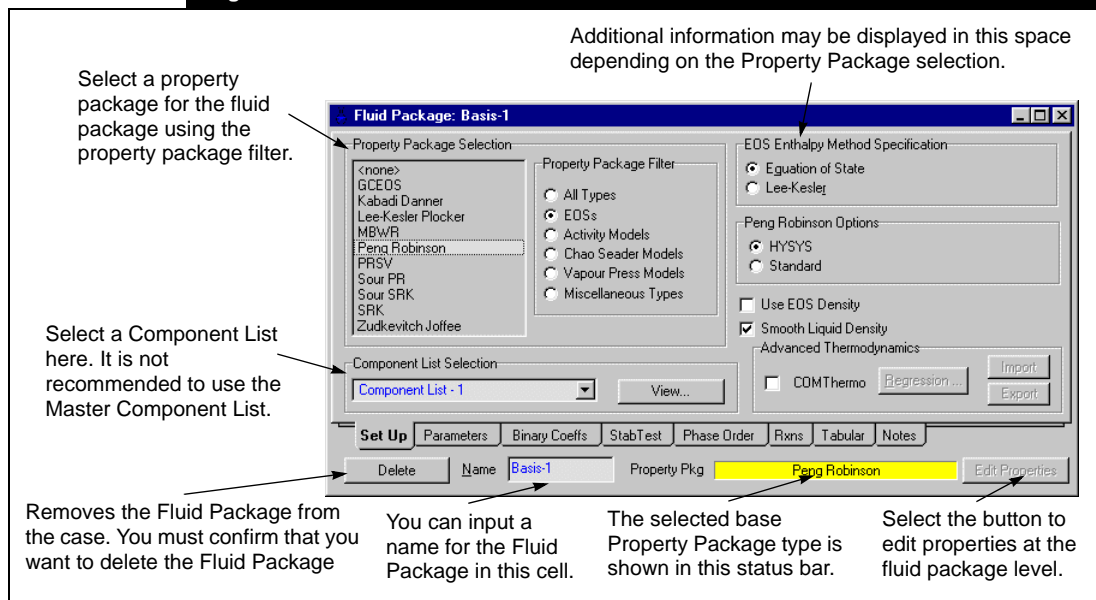

2.4.1 Set Up Tab

The Set Up tab is the first tab of the Fluid Package property view. When you create a new Fluid Package, the Fluid Package view appears as shown above. The Set Up tab contains the Property Package Selection, Component List Selection, Property Package Filter and Thermodynamics groups. Once a Property Package is selected, additional information and options may be displayed to the right of the Property Package Selection group. This is shown above with the EOS Enthalpy Method Specification group for the Peng-Robinson property package. The information that is displayed is dependent on the selected Property Package.

The following sections provide an overview of the various Property Packages, as well as details on the various groups that appear on the Set Up tab.

Property Package Selection

In the Property Package Selection group, you have access to the list of all the Property Methods available in HYSYS and to the Property Package Filter group.

The Property Package Filter allows you to filter the list of available property methods, based on the following criteria:

Filter	Description
All Types	All the Property Packages appear in the list.
EOSs	Only Equations of State appear in the list.
Activity Models	Only Liquid Activity Models appear in the list.
Chao Seader Models	Only Chao Seader based Semi Empirical methods are displayed.
Vapour Pressure Models	Vapour pressure K-value models are shown in the list.
Miscellaneous	Models that do not fit into any of the above 4 categories (i.e., excluding All) are displayed.

For more detailed information about the property packages available in HYSYS, refer to [Appendix A - Property Methods & Calculations](#).

Equations of State

For oil, gas and petrochemical applications, the Peng-Robinson Equation of State is generally the recommended property package. Hyprotech's enhancements to this equation of state enable it to be accurate for a variety of systems over a wide range of conditions. It rigorously solves most single phase, two phase and three-phase systems with a high degree of efficiency and reliability.

All equation of state methods and their specific applications are described below:

EOS	Description
GCEOS	This model allows you to define and implement your own generalized cubic equation of state including mixing rules and volume translation.
Kabadi Danner	This model is a modification of the original SRK equation of state, enhanced to improve the vapour-liquid-liquid equilibria calculations for water-hydrocarbon systems, particularly in dilute regions.
Lee-Kesler Plocker	This model is the most accurate general method for non-polar substances and mixtures.
Peng-Robinson	This model is ideal for VLE calculations as well as calculating liquid densities for hydrocarbon systems. Several enhancements to the original PR model were made to extend its range of applicability and to improve its predictions for some non-ideal systems. However, in situations where highly non-ideal systems are encountered, the use of Activity Models is recommended.
PRSV	This is a two-fold modification of the PR equation of state that extends the application of the original PR method for moderately non-ideal systems.
SRK	In many cases it provides comparable results to PR, but its range of application is significantly more limited. This method is not as reliable for non-ideal systems.
Sour PR	Combines the PR equation of state and Wilson's API-Sour Model for handling sour water systems.
Sour SRK	Combines the Soave Redlich Kwong and Wilson's API-Sour Model.
Zudkevitch Joffee	Modification of the Redlich Kwong equation of state. This model has been enhanced for better prediction of vapour-liquid equilibria for hydrocarbon systems, and systems containing Hydrogen.

Activity Models

Although Equation of State models have proven to be very reliable in predicting the properties of most hydrocarbon based fluids over a wide range of operating conditions, their application is limited to primarily non-polar or slightly polar components. Highly non-ideal systems are best modeled using Activity Models.

The following Activity Model Property Packages are available:

Activity Model	Description
Chien Null	Provides a consistent framework for applying existing Activity Models on a binary by binary basis. It allows you to select the best Activity Model for each pair in your case.
Extended NRTL	This variation of the NRTL model allows you to input values for the A_{ij} , B_{ij} , C_{ij} , $Alp1_{ij}$ and $Alp2_{ij}$ parameters used in defining the component activity coefficients. Apply this model to systems: <ul style="list-style-type: none"> • with a wide boiling point range between components. • where you require simultaneous solution of VLE and LLE, and there exists a wide boiling point range or concentration range between components.
General NRTL	This variation of the NRTL model allows you to select the equation format for equation parameters: τ and α . Apply this model to systems: <ul style="list-style-type: none"> • with a wide boiling point range between components. • where you require simultaneous solution of VLE and LLE, and there exists a wide boiling point or concentration range between components.
Margules	This was the first Gibbs excess energy representation developed. The equation does not have any theoretical basis, but is useful for quick estimates and data interpolation.
NRTL	This is an extension of the Wilson equation. It uses statistical mechanics and the liquid cell theory to represent the liquid structure. It is capable of representing VLE, LLE, and VLLE phase behaviour.
UNIQUAC	Uses statistical mechanics and the quasi-chemical theory of Guggenheim to represent the liquid structure. The equation is capable of representing LLE, VLE, and VLLE with accuracy comparable to the NRTL equation, but without the need for a non-randomness factor.
van Laar	This equation fits many systems quite well, particularly for LLE component distributions. It can be used for systems that exhibit positive or negative deviations from Raoult's Law, however, it cannot predict maxima or minima in the activity coefficient. Therefore it generally performs poorly for systems with halogenated hydrocarbons and alcohols.
Wilson	First activity coefficient equation to use the local composition model to derive the Gibbs Excess energy expression. It offers a thermodynamically consistent approach to predicting multi-component behaviour from regressed binary equilibrium data. However the Wilson model cannot be used for systems with two liquid phases.

Chao Seader & Grayson Streed Models

The Chao Seader and Grayson Streed methods are older, semi-empirical methods. The Grayson Streed correlation is an extension of the Chao Seader method with special emphasis on hydrogen. Only the equilibrium data produced by these correlations is used by HYSYS. The Lee-Kesler method is used for liquid and vapour enthalpies and entropies.

Model	Description
Chao Seader	Use this method for heavy hydrocarbons, where the pressure is less than 10342 kPa (1500 psia), and temperatures range between -17.78 and 260 °C (0-500 °F).
Grayson Streed	Recommended for simulating heavy hydrocarbon systems with a high hydrogen content.

Vapour Pressure Models

Vapour Pressure K-value models may be used for ideal mixtures at low pressures. Ideal mixtures include hydrocarbon systems and mixtures such as ketones and alcohols, where the liquid phase behaviour is approximately ideal. The models may also be used as first approximations for non-ideal systems. The following vapour pressure models are available:

Vapour Pressure Models	Description
Antoine	This model is applicable for low pressure systems that behave ideally.
Braun K10	This model is strictly applicable to heavy hydrocarbon systems at low pressures. The model employs the Braun convergence pressure method, where, given the normal boiling point of a component, the K-value is calculated at system temperature and 10 psia (68.95 kPa).
Esso Tabular	This model is strictly applicable to hydrocarbon systems at low pressures. The model employs a modification of the Maxwell-Bonnel vapour pressure model.

Miscellaneous

The Miscellaneous group contains Property Packages that are unique and do not fit into the groups previously mentioned.

Amines is an optional Property Package. Contact your Hyprotech representative for further information. For more information on the package see [Appendix C - Amines Property Package](#).

For more information on the OLI_Electrolyte property package, refer to [Section 1.6 - HYSYS OLI_Electrolyte Property Package](#) in the [HYSYS OLI Interface Reference Guide](#).

Property Package	Description
Amine Pkg	Contains thermodynamic models developed by D.B. Robinson & Associates for their proprietary amine plant simulator, AMSIM. You can use this property package for amine plant simulations with HYSYS.
ASME Steam	Restricted to a single component, namely H2O. Uses the ASME 1967 Steam Tables.
NBS Steam	Restricted to a single component, namely H2O. Utilizes the NBS 1984 Steam Tables.
MBWR	This is a modified version of the original Benedict/Webb/Rubin equation. This 32-term equation of state model is applicable for only a specific set of components and operating conditions.
OLI_Electrolyte	Developed by OLI Systems Inc. and used for predicting the equilibrium properties of a chemical system including phase and reactions in a water solution.

Component List Selection

You must also select a Component List to associate with the current Fluid Package from the Component List Selection drop-down list. Component Lists are stored outside of the Fluid Package Manager in the Components Manager and may contain traditional, hypothetical, and electrolyte components.

It is not recommended for users to attach the Master Component List to any Fluid Package. If only the master list exists, by default a cloned version of the Master Component List is created (called Component List -1). This list is selected initially when a new Fluid Package is created.

HYSYS provides a warning message when you attempt to associate a Component List containing incompatible and/or not recommended components, with your property package.

Also, if you switch between property packages, and any components are incompatible or not recommended for use with the current property package, a view appears providing further options (see the following Warning Messages section).

Warning Messages

There are two different warning views that you may encounter while modifying a Fluid Package. These situations arise when a Component List is installed into the Fluid Package and you want to select a new property package. Some components from the selected Component List may either not be recommended or are incompatible with the new property package selection.

The first view involves the use of Non-Recommended components. In HYSYS, you can select components that are not recommended for use with the current property package. If you try to switch to another property package for which the components are not recommended, the following view appears:

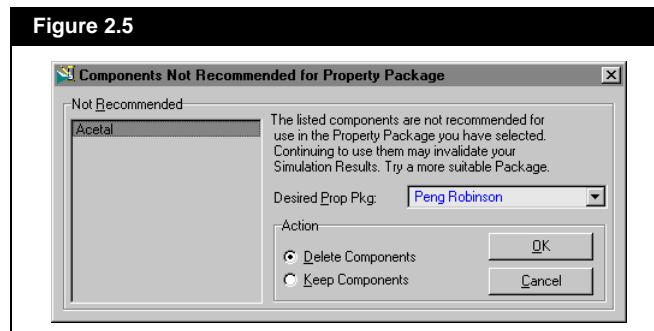

The objects from the Components Not Recommended for Property Package view are described below:

Object	Description
Not Recommended	The non-recommended components are listed in this group.
Desired Prop Pkg	This field initially displays the Property Package for which the listed components are Not Recommended. This field is also a drop-down list of all available Property Packages so you may make an alternate selection without returning to the Fluid Package property view.
Action	This group box contains two radio buttons: <ul style="list-style-type: none"> • Delete Components. This removes incompatible components from the Fluid Package. • Keep Components. This keeps the components in the Fluid Package.
OK	Accepts the Desired Prop Pkg with the appropriate Action.
Cancel	Return to the Prop Pkg tab without making changes.

The second dialog involves the use of Incompatible components. If you try to switch to a property package for which the components are incompatible, the following view appears:

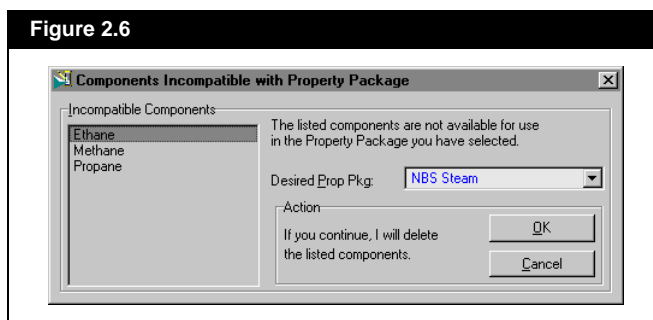

The Objects from the Components Incompatible with Property Package view are described below:

Object	Description
Incompatible Components	The incompatible components are listed in this group.
Desired Prop Pkg	This field initially displays the Property Package for which the listed components are Incompatible. This field is also a drop-down list of all available Property Packages so you may make an alternate selection without returning to the Fluid Package property view.
OK	This button accepts the Desired Prop Pkg with the appropriate Action (i.e., delete the incompatible components).
Cancel	Press this button to keep the current Property Package

Additional Property Package Options

When you have selected a Property Package, additional information and options may be displayed on the right side of the Set Up tab. This information is directly related to the Property Package type selected.

In this section, the additional information displayed with the property method selection is discussed. The groups that are encountered are shown below. It should be noted that not all EOS's or Activity models include the specifications indicated.

Property Packages	Specifications and Options
Equation of States	EOS Enthalpy Method Specification , Peng Robinson Options , EOS Density and Smooth Liquid Density Specifications
Activity Models	Activity Model Specifications
Amine Pkg	Amine Options: <ul style="list-style-type: none"> • Thermodynamic Models for Aqueous Amine Solutions • Vapour Phase Model
OLI_Electrolyte	OLI Electrolyte Options: <ul style="list-style-type: none"> • Initialize and View Electrolytes • Phase and Solid options

EOS Enthalpy Method Specification

The Lee-Kesler Plocker (LKP) and Zudkevitch Joffe (ZJ) property packages both use the Lee-Kesler enthalpy method. You cannot change the enthalpy method for either of these Equations of State (i.e., [Figure 2.7](#) is not displayed).

Figure 2.7

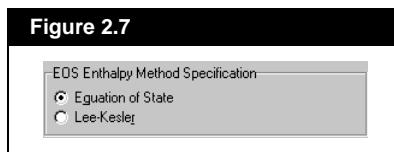

With any other Equation of State, you have a choice for the enthalpy method as described below:

Enthalpy Method	Description
Equation of State	With this radio button selection, the enthalpy method contained within the Equation of State is used.
Lee-Kesler	The Lee-Kesler method is used for the calculation of enthalpies. This option results in a combined Property Package, employing the appropriate equation of state for vapour-liquid equilibrium calculations and the Lee-Kesler equation for the calculation of enthalpies and entropies. This method yields comparable results to HYSYS' standard equations of state and has identical ranges of applicability.

Lee-Kesler enthalpies may be slightly more accurate for heavy hydrocarbon systems, but require more computer resources because a separate model must be solved.

Peng Robinson Options

The Peng Robinson options are only available when the Peng Robinson property package is selected. The options are explained in the table below:

Option	Description
HYSYS	The HysysPR EOS is similar to the PR EOS with several enhancements to the original PR equation. It extends its range of applicability and better represents the VLE of complex systems.
Standard	This is the standard Peng Robinson (1976) equation of state, a modification of the RK equation to better represent the VLE of natural gas systems accurately.

For more information on property packages, refer to [Section A.3.1 - Equations of State](#) in Appendix A.

EOS Density and Smooth Liquid Density Specifications

The Use EOS Density and Smooth Liquid Density checkboxes affect the PR, PRSOUR, SRK, and SRKSOUR property packages. In previous versions to HYSYS 3.0, these property packages used the Costald liquid density model. This method was only applied when the reduced temperature (T_r) was less than unity. When the reduced temperature exceeded unity, it switched to the EOS liquid density. Hence, at $T_r=1$ there is a sharp change (discontinuity) in the liquid density causing problems especially in dynamics mode.

For older cases including HYSIM cases, the density smoothing option is not selected. This means that liquid densities in cases using the smoothing option may differ from those cases in the past.

By default, new cases have the density smoothing option selected and EOS density not selected, which is the recommended option. By default, or if the smoothing option is selected, HYSYS interpolates the liquid densities from $T_r=0.95$ to $T_r=1.0$, giving a smooth transition. It should be noted that the densities differ if the option is not selected.

If both the Use EOS Density and Smooth Liquid Density boxes are not selected, the behaviour and results are the same as before (previous to HYSYS 3.0) and can cause problems as discussed earlier.

Costald typically gives better liquid densities and smoothing near $T_r = 1$ is common.

Activity Model Specifications

The Activity Model Specification group appears for each activity model. There are three specification items within this group as shown in the following figure.

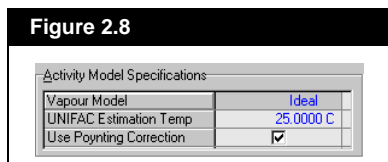

Activity Models only perform calculations for the liquid phase, thus, you are required to specify the method to be used for solving the vapour phase. The first field in the Activity Model Specifications group allows you to select an appropriate Vapour Model for your fluid package.

The list of vapour phase models are accessed through the drop-down list and are described below.

Vapour Phase Models	Description
Ideal	The HYSYS default. It is applied for cases in which you are operating at low or moderate pressures.
RK	The generalized Redlich Kwong cubic equation of state is based on reduced temperature and reduced pressure, and is generally applicable to all gases.
Virial	Enables you to better model the vapour phase fugacities of systems that display strong vapour phase interactions. Typically this occurs in systems containing carboxylic acids, or other compounds that have the tendency to form stable hydrogen bonds in the vapour phase.
PR	Uses the Peng Robinson EOS to model the vapour phase. Use this option for all situations to which PR is applicable.
SRK	Uses the Soave Redlich Kwong EOS to model the vapour phase. Use this option for all situations to which SRK is applicable.

The second field in the Activity Model Specifications group is the UNIFAC Estimation Temp. This temperature is used to estimate interaction parameters using the UNIFAC method. By default, the temperature is 25 °C, although better results are achieved if you select a temperature that is closer to your anticipated operating conditions.

The third field in this group is a checkbox for the Poynting Correction. This checkbox toggles the Poynting correction factor, which by default, is activated. The correction factor is only available for vapour phase models. The correction factor uses each component's molar volume (liquid phase) in the calculation of the overall compressibility factor.

Amine Options

The following Amine options are available when the Amine pkg is selected.

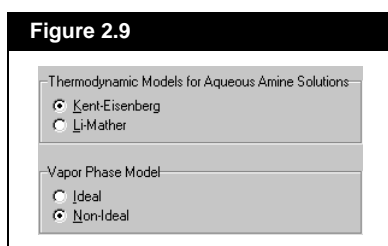

The Thermodynamic Models for Aqueous Amine Solutions allows you to select between the Kent-Eisenberg and Li-Mather models. Refer to the [Appendix C.4 - Equilibrium Solubility](#) for detailed information on each model. The Vapour Phase Model group allows you to select between Ideal and Non-Ideal models.

OLI_Electrolyte Options

Refer to the [HYSYS OLI Interface Reference Guide](#) for detailed information on electrolytes.

If the OLI_Electrolyte property package is selected for the fluid package, the following electrolyte options appear on the right side of the view.

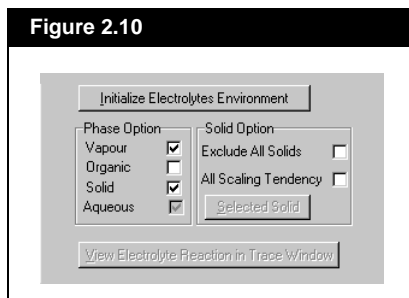

After selecting electrolyte components for a component list from the database, a electrolyte system is established. The initialize Electrolytes Environment button is used for the following:

- Generating a group of additional components based on the selected components and the setting in Phase Option and Solid Option below.
- Generating a corresponding Chemistry model for thermodynamic calculation.

The phase option includes the vapour, organic, solid, and aqueous phases. The checkboxes allow you to select the material phases that are considered during the flash calculation. The vapour, organic and solid phases, may be included or excluded from calculations. The aqueous phase must be included in all electrolyte simulations and is not accessible. By default, the vapour and solid phases are selected with the organic phase unchecked.

The flexibility of selecting different phase combinations and the procedure for phase mixing used by the flash calculation is described in the following table:

Phases Included	Description of the Flash Action
Vapour and Solid	Generates vapour and solid phases when they exist. If an organic phase appears, it is included in the vapour phase.
Organic and Solid	Generates the organic and solid phase when they exist. If a vapour phase appears, it is included in the organic phase.
Vapour and Organic	Generates the vapour and organic phase when they exist. If a solid phase appears, it is included in the aqueous phase.
Vapour only	Generates the vapour phase when it exists. If an organic phase appears, it will be included in the vapour phase and if a solid phase appears, it is included in the aqueous phase.
Organic Only	Generates the organic phase when it exists. If a vapour phase appears, it will be included in the organic phase and if a solid phase appears, it is included in the aqueous phase.
Solid Only	An electrolyte case with no organic or vapour phase is impossible and is not be accepted.

Refer to [Section 1.6.6 - Disabling Solid Components](#) in the **HYSYS OLI Interface Guide** for more information on including and excluding solids.

Refer to [Section 1.6.7 - Scaling Tendencies](#) of the **HYSYS OLI Interface Guide** for more information on scaling tendencies.

The Solid Option group includes two checkboxes and the Selected Solid button. HYSYS allows you to exclude all solids in your case by selecting the Exclude All Solids checkbox. It also allows you to exclude solid components individually when the solid phase is included by disabling solid components that are not of interest in the simulation. To do this, you must invoke Initialize Electrolytes Environment first, and then click the Selected Solid button. When you click the button, you can select any component that you want to be included or excluded in all of the Electrolyte streams from the case. When the solid components are excluded, you have to re-initialize the Electrolytes Environment.

If you select the All Scaling Tendency checkbox, all solids are excluded from the case, but the Scaling Tendency Index is still calculated in the flash calculation.

The View Electrolyte Reaction in Trace Window button is activated when the Electrolytes Environment is initialized. It allows you to view what reaction(s) are involved in the Thermo flash calculation in the trace window.

2.4.2 Parameters Tab

The information and options displayed on the Parameters tab is dependent on the Property Package selection. Some Property Packages have nothing on the Parameters tab, while others display additional information required. Those Property Packages which have information on the Parameters tab are mentioned in this section.

If a value is estimated by HYSYS, it is indicated in red and can be modified.

GCEOS (Generalized Cubic EOS)

The Generalized Cubic Equation of State (GCEOS) is an alternative to the standard equation of state property packages. It allows you to define and customize the cubic equation to your own specifications.

Figure 2.11

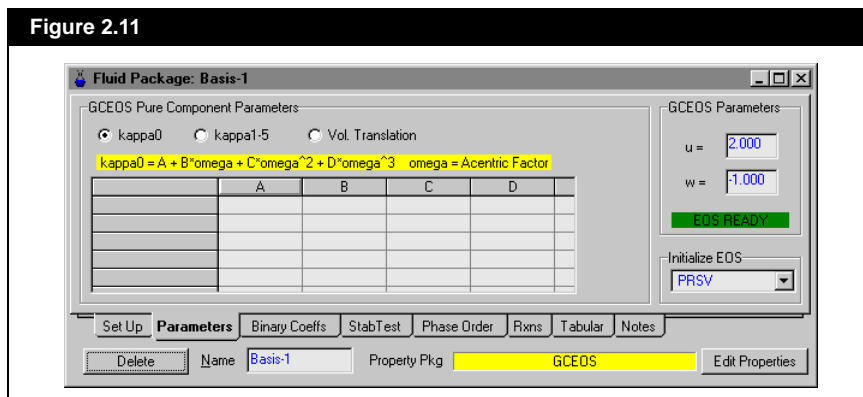

Generalized Cubic Equation of State

To gain an understanding of how to specify the GCEOS property package Parameters tab, you must first consider the general cubic equation of state form:

$$P = \frac{RT}{v-b} - \frac{a(T)}{v^2 + ubv + wb^2} \quad (2.1)$$

OR

$$Z^3 + C_1 Z^2 + C_2 Z + C_3 = 0 \quad (2.2)$$

where:

$$\begin{aligned} C_1 &= Bu - B - 1 \\ C_2 &= B^2 w - B^2 u - Bu + A \\ C_3 &= -(B^3 w + B^2 w + AB) \end{aligned} \quad (2.3)$$

$$Z = \frac{Pv}{RT} \quad (2.4)$$

$$A = \frac{a_{mix} P}{R^2 T^2} \quad (2.5)$$

$$B = \frac{b_{mix} P}{RT} \quad (2.6)$$

$$a_{mix} = \sum \sum x_i x_j \sqrt{a_i(T) a_j(T)} \times MR_{ij} \quad (2.7)$$

$$b_{mix} = \sum x_i b_i \quad (2.8)$$

$$a_i(T) = a_c \alpha \quad (2.9)$$

$$a_c = \left(\frac{3 + (u-w)\xi^2}{3 + (u-1)\xi} + u\xi \right) RT_c V_c \quad (2.10)$$

$$b_i = \xi V_c \quad (2.11)$$

$$[u(w+u)-w]\xi^3 + 3(w+u)\xi^2 + 3\xi - 1 = 0 \quad (2.12)$$

MR_{ij} = the mixing rule

To calculate the values of b_i and a_c , the cubic equation, [Equation \(2.12\)](#), is solved to find a value for ξ .

The value of a_i in [Equation \(2.9\)](#) requires you to use the α term.

$$\alpha(T) = [1 + \kappa(1 - T_R^{0.5})]^2 \quad (2.13)$$

α in turn is made up of the κ term. The parameter κ is a polynomial equation containing five parameters: κ_0 , κ_1 , κ_2 , κ_3 , κ_4 and κ_5 . The parameter κ_0 is also represented by a polynomial equation consisting of 4 parameters (A , B , C and D).

$$\kappa = \kappa_0 + [\kappa_1 + (\kappa_2 - \kappa_3 T_R)(1 - T_R^{\kappa_4})] \times (1 + T_R^{0.5})(0.7 - T_R) \times T^{\kappa_5} \quad (2.14)$$

$$\kappa_0 = A + B\omega + C\omega^2 + D\omega^3 \quad (2.15)$$

The Parameters tab for the GCEOS consists of three group boxes:

- GCEOS Pure Component Parameters
- GCEOS Parameters
- Initialize EOS

GCEOS Pure Component Parameters Group

This group allows you to define α by specifying the values of κ_0 - κ_5 .

To specify the value of κ_0 , select the kappa0 radio button and a view similar to the one shown in [Figure 2.12](#) should appear. The group consists of a matrix containing 4 parameters of [Equation \(2.15\)](#): A , B , C , and D for each component selected in the Fluid Package.

Figure 2.12

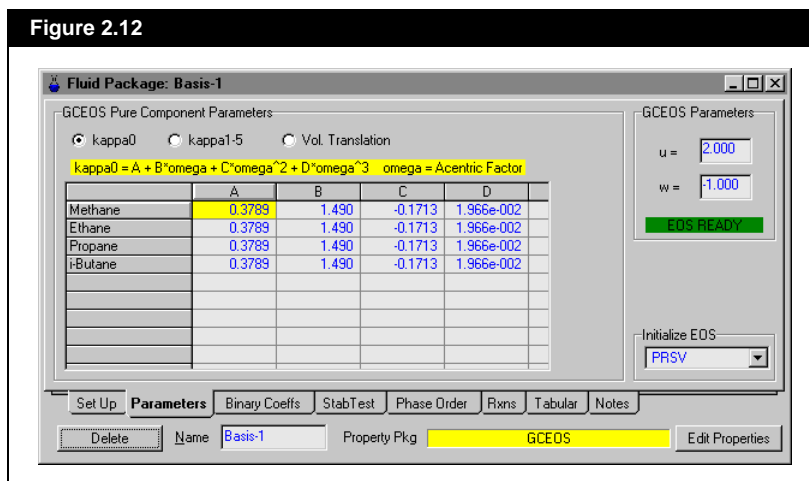

To specify the remaining kappa parameters (i.e., κ_1 - κ_5), select the kappa1-5 radio button. A new matrix appears in the GCEOS Pure Component Parameters group.

Figure 2.13

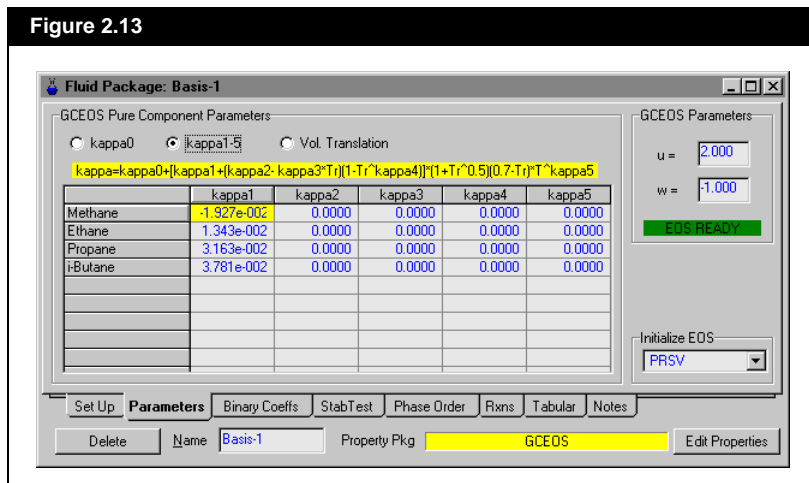

This matrix allows you to specify the κ values for each component in the Fluid Package.

Volume Translation

The GCEOS allows for volume translation correction to provide a better calculation of liquid volume by the cubic equations of state. The correction is simply a translation along the volume axis, which results in a better calculation of liquid volume without affecting the VLE calculations. Mathematically this volume shift is represented as:

$$\bar{v} = v - \sum_{i=1}^n x_i c_i \quad (2.16)$$

$$\bar{b} = b - \sum_{i=1}^n x_i c_i \quad (2.17)$$

where: \bar{v} = translated volume

\bar{b} = is the translated cubic equation of state parameter

c_i = the pure component translated volume

x_i = the mole fraction of component i in the liquid phase.

The resulting equation of state appears as shown in [Equations \(2.4\)](#), [\(2.5\)](#) and [\(2.6\)](#) with b and v replaced with the translated values (\bar{v} and \bar{b}).

To specify the value of the pure component correction volume, c_i , select the Vol. Translation radio button. A view similar to the one shown in [Figure 2.14](#) will appear.

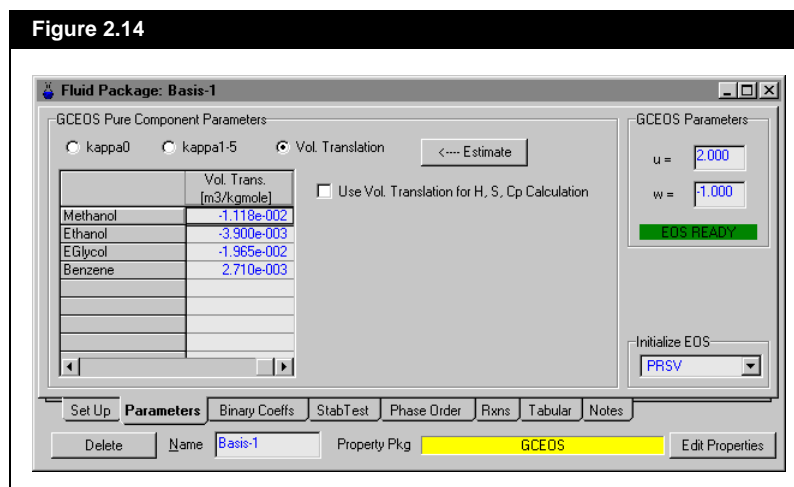

HYSYS only estimates the correction volume constant for those components whose cells have no value (i.e., they contain 0.000). If you specify one value in the matrix and click the Estimate button, you are only estimating those empty cells.

To estimate a cell containing a previously entered value, select the cell, delete the current value and click the **Estimate** button.

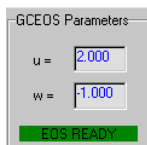

The GCEOS Pure Components Parameters group now contains a matrix containing the volume correction constants for each component currently selected. The matrix should initially be empty. You may enter your own values into this matrix or you may click the Estimate button and have HYSYS estimate values for you. c_i is estimated by matching liquid volume at normal boiling point temperature with that of the liquid volume obtained from an independent method (COSTALD).

GCEOS Parameters Group

The GCEOS Parameters group allows you to specify the u and w parameters found in [Equations \(2.3\)](#) to [\(2.15\)](#).

The following table lists the u and w values for some common equations of state:

EOS	u	w
van der Waals	0	0
Redlich-Kwong	1	0
Peng-Robinson	2	-1

Equation Status Bar

The GCEOS Parameter group also contains the Equation Status Bar. It tells you the status of the equation definition. There are two possible messages and are described as follows:

Message	Description
EOS NOT READY	This message appears if poor values are chosen for u and w .
EOS READY	If the values selected for u and w are suitable this message appears.

Initialize EOS

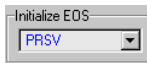

The Initialize EOS drop-down list allows you to initialize GCEOS Parameters tab with the default values associated with the selected Equation of State.

The four options available are as follows:

- van der Waals Equation
- SRK Equation
- PR Equation
- PRSV Equation

Kabadi Danner

The Kabadi Danner Property Package uses Group Parameters that are automatically calculated by HYSYS. The values are generated from Twu's method.

Figure 2.15

 A screenshot of a table titled "Group Parameters [atm·m⁶/mol²]" showing values for various hydrocarbons. The value for Hypo20000* is highlighted in red.

	Group Parameter E-5
Methane	1.3580
Ethane	2.1980
Propane	3.0071
i-Butane	3.7647
n-Butane	4.0274
Hypo20000*	6.5959

Peng-Robinson Strujek Vera (PRSV)

PRSV uses an empirical factor, Kappa, for fitting pure component vapour pressures.

Figure 2.16

PRSV Component Parameters	
	Kappa
Methane	-0.0193
Ethane	0.0134
Propane	0.0316
i-Butane	0.0378
n-Butane	0.0395
Hypo20000*	0.0325

Zudkevitch Joffee

This Property Package uses a b zero Parameter. HYSYS sets the b zero parameter of the ZJ equation to be zero.

Figure 2.17

b zero Parameters	
	b zero Parameter
Methane	0.0000
Ethane	0.0000
Propane	0.0000
i-Butane	0.0000
n-Butane	0.0000
Hypo20000*	0.0000

Chien Null

The Chien Null model provides a consistent framework for applying different activity models on a binary by binary basis. On the Parameters tab, you can specify the Activity Model to be used for each component pair, as well as two additional pure component parameters required by the model.

The two groups on the Parameters tab for the Chien Null property package are:

- Chien Null Component Parameters
- Chien Null Binary Component Parameters

Component Parameters

Values for the Solubility and Molar Volume are displayed for each library component and estimated for hypotheticals.

Figure 2.18

Component	Solubility	Molar Volume (m ³ /kgmole)
2-Propanol	11.5110	0.0103
H2O	21.9110	0.0025
Ethanol	12.9680	0.0078
Benzene	8.9185	0.0121
1-Butanol	10.9460	0.0125
Hypo20000*	7.3395	0.1534

The Molar Volume parameter is used by the Regular Solution portion of the Chien Null equation. The Regular Solution is an Activity Model choice for Binary pair computations (see the following section).

Binary Component Parameters

All of the components in the case, including hypotheticals, are listed in the matrix. You can view the details for the liquid and vapour phase calculations by selecting the appropriate radio button:

- Liq Activity Models
- Virial Coefficients

Figure 2.19

	2-Propanol	H2O	Ethanol	Benzene	1-Butanol	Hypo20000*
2-Propanol	---	NRTL	NRTL	NRTL	NRTL	NRTL
H2O	NRTL	---	NRTL	NRTL	NRTL	NRTL
Ethanol	NRTL	NRTL	---	NRTL	NRTL	NRTL
Benzene	NRTL	NRTL	NRTL	---	NRTL	NRTL
1-Butanol	NRTL	NRTL	NRTL	NRTL	---	NRTL
Hypo20000*	NRTL	NRTL	NRTL	NRTL	NRTL	---

The Property Packages available in the drop-down list are:

- None Required
- Henry
- van Laar
- Margules
- NRTL
- Scatchard
- Reg Soln
- General

By selecting the Liq Activity Models radio button, you can specify the Activity Model that HYSYS uses for the calculation of each binary. The matrix displays the default property package method selected by HYSYS for each binary pair. The choices are accessed by highlighting the drop-down list in each cell. If Henry's Law is applicable to a component pair, HYSYS selects this as the default property method. When Henry's Law is selected by HYSYS, you cannot modify the model for the binary pair.

In the previous view, NRTL was selected as the default property package for all binary pairs. You can use the default selections, or you can set the property package for each binary pair. Remember that the selected method appears in both cells representing the binary. HYSYS may filter the list of options according to the components involved in the binary pair.

By selecting the Virial Coefficients radio button, you can view and edit the virial coefficients for each binary. Values are only shown in this table when the Virial Vapour model is selected on the Set Up tab. You can use the default values suggested by HYSYS or edit these values. Virial coefficients for the pure species are shown along the diagonal of the matrix table, while cross coefficients, which are mixture properties between components, are those not along the diagonal.

Wilson

The Molar Volume for each library component is displayed, as well as those values estimated for hypotheticals.

Figure 2.20

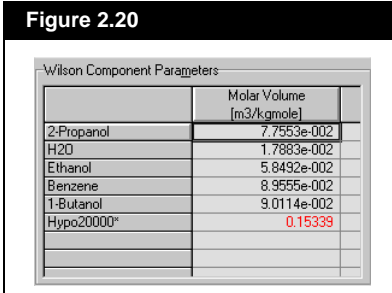

Wilson Component Parameters	
	Molar Volume [m ³ /kgmole]
2-Propanol	7.7553e-002
H2O	1.7883e-002
Ethanol	5.8492e-002
Benzene	8.9555e-002
1-Butanol	9.0114e-002
Hypo20000*	0.15339

Chao Seader & Grayson Streed

The Chao Seader and Grayson Streed models also use a Molar Volume term. Values for Solubility, Molar Volume, and Acentricity are displayed for library components. The parameters are estimated for hypotheticals.

Figure 2.21

	Solubility	Molar Volume [m ³ /kgmole]	Acentricity
Methane	6.8519	0.0520	0.0000
Ethane	4.2869	0.0670	0.1064
Propane	5.9990	0.0840	0.1538
i-Butane	6.2881	0.1055	0.1825
n-Butane	6.7133	0.1014	0.1953
Hypo20000*	7.3395	0.1534	0.3364

Antoine

HYSYS uses a six term Antoine expression, with a fixed F term. For library components, the minimum and maximum temperature and the coefficients (A through F) are displayed for each component. The values for Hypothetical components are estimated.

Figure 2.22

	Tmin [C]	Tmax [C]	Coeff A	Coeff B	Coeff C	Coeff D	Coeff E	Coeff F
2-Propanol	-23.15	235.1	8.364e+01	-8.249e+03	0.000e-01	-9.545e+00	2.003e-06	2.000e+00
H2O	1.850	374.1	6.593e+01	-7.228e+03	0.000e-01	-7.177e+00	4.031e-06	2.000e+00
Ethanol	19.85	238.9	8.649e+01	-7.931e+03	0.000e-01	-1.025e+01	6.389e-06	2.000e+00
Benzene	-60.15	278.9	1.637e+02	-1.031e+04	0.000e-01	-2.359e+01	2.094e-05	2.000e+00
1-Butanol	1.850	289.9	1.088e+02	-1.007e+04	0.000e-01	-1.326e+01	4.380e-06	2.000e+00
Hypo20000*	115.0	296.2	5.569e+01	-6.451e+03	0.000e-01	-5.784e+00	9.241e-18	6.000e+00

Fluid Package: Basis-1

Set Up Parameters Binary Coeffs StabTest Phase Order Rxns Tabular Notes

Delete Name Basis-1 Property Pkg Antoine Edit Properties

2.4.3 Binary Coefficients Tab

The Binary Coefficients (Binary Coeffs) tab contains a matrix table which lists the interaction parameters for each component pair. Depending on the property method selected, different estimation methods may be available and a different view may be shown. You have the option of overwriting any library value.

The cells with unknown interaction parameters contain dashes (---). When you exit the Basis Manager, unknown interaction parameters are set to zero.

For all matrices on the Binary Coeffs tab, the horizontal components across the top of the matrix table represent the "i" component and the vertical components represent the "j" component.

Generalized Cubic Equation of State Interaction Parameters

When GCEOS is the selected property package on the Set Up tab, the Binary Coeffs tab appears as shown below.

Figure 2.23

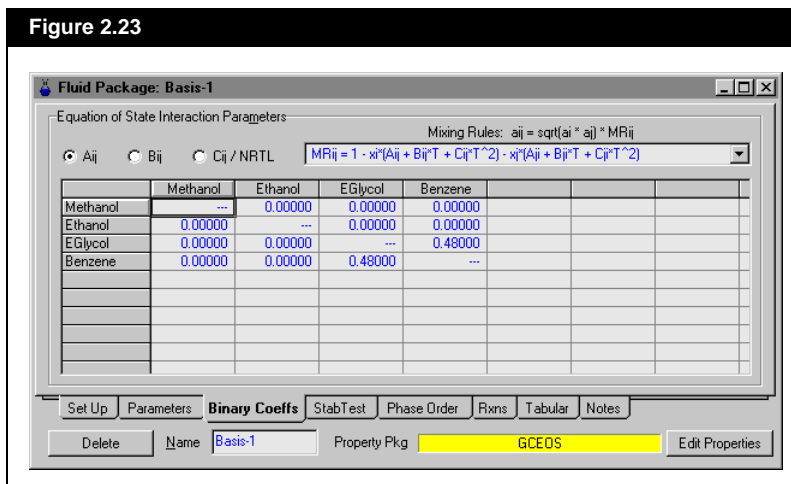

The GCEOS property package allows you to select mixing methods used to calculate the equation of state parameter, a_{ij} . HYSYS assumes the following general mixing rule:

$$a_{ij} = \sqrt{a_i a_j} MR_{ij} \quad (2.18)$$

where: MR_{ij} = the mixing rule parameter.

There are seven methods to choose for MR_{ij} :

Equation	
$MR_{ij}(T) = (1 - A_{ij} + B_{ij}T + C_{ij}T^2)$	(2.19)
$MR_{ij}(T) = (1 - A_{ij} + B_{ij}T + C_{ij}/T)$	(2.20)
$MR_{ij}(T) = 1 - x_i(1 - A_{ij} + B_{ij}T + C_{ij}T^2) - x_j(1 - A_{ij} + B_{ij}T + C_{ij}T^2)$	(2.21)
$MR_{ij}(T) = 1 - x_i(1 - A_{ij} + B_{ij}T + C_{ij}/T) - x_j(1 - A_{ij} + B_{ij}T + C_{ij}/T)$	(2.22)
$MR_{ij}(T) = 1 - \frac{(k_{ij} \times k_{ji})}{x_i k_{ij} + x_j k_{ji}}$	(2.23)
<div data-bbox="150 1070 412 1097" style="border: 1px solid black; padding: 2px; margin-bottom: 5px;">Van-Laar $k_{ij} = A_{ij} + B_{ij}T + C_{ij}T^2$</div> <p>where: $k_{ij} = A_{ij} + B_{ij}T + C_{ij}T^2$</p>	
$MR_{ij}(T) = 1 - \frac{(k_{ij} \times k_{ji})}{x_i k_{ij} + x_j k_{ji}}$	(2.24)
<div data-bbox="166 1251 403 1278" style="border: 1px solid black; padding: 2px; margin-bottom: 5px;">Van-Laar $k_{ij} = A_{ij} + B_{ij}T + C_{ij}/T$</div> <p>where: $k_{ij} = A_{ij} + B_{ij}T + \frac{C_{ij}}{T}$</p>	
Wong Sandler Mixing Rule - See the following subsection.	

Each mixing rule allows for the specification of three parameters: A_{ij} , B_{ij} and C_{ij} , except for the Wong Sandler mixing rule which has the A_{ij} and B_{ij} parameter and also requires you to provide NRTL binary coefficients.

The parameters are available through the three radio buttons in the upper left corner of the tab: Aij, Bij and Cij/NRTL. By selecting a certain parameter's radio button you may view the associated parameter matrix table.

When selecting the Cij/NRTL radio button you are specifying the C_{ij} parameter unless you are using the Wong Sandler mixing rule. In this case you are specifying NRTL binary coefficients used to calculate the Helmholtz energy.

Wong Sandler Mixing Rule

The Wong Sandler¹ mixing rule is a density independent mixing rule in which the equation of state parameters a_{mix} and b_{mix} of any cubic equation of state are determined by simultaneously solving:

- the excess Helmholtz energy at infinite pressure.
- the exact quadratic composition dependence of the second virial coefficient.

To demonstrate this model, consider the relationship between the second virial coefficient $B(T)$ and the equation of state parameters a and b :

$$B(T) = b - \frac{a}{RT} \quad (2.25)$$

Consider the quadratic composition dependence of the second virial coefficient as:

$$B_m(T) = \sum_i \sum_j x_i x_j B_{ij}(T) \quad (2.26)$$

Substitute B with the relationship in [Equation \(2.25\)](#):

$$b_{mix} - \frac{a_{mix}}{RT} = \sum_i \sum_j x_i x_j \left(b - \frac{a}{RT} \right)_{ij} \quad (2.27)$$

To satisfy the requirements of [Equation \(2.27\)](#), the relationship for a_{mix} and b_{mix} are:

$$b_{mix} = \frac{\sum_i \sum_j x_i x_j \left(b - \frac{a}{RT} \right)_{ij}}{1 - \frac{F(x)}{RT}} \quad (2.28)$$

with:

$$a_{mix} = b_{mix} F(x) \quad (2.29)$$

where: $F(x)$ = is an arbitrary function

The cross second virial coefficient of [Equation \(2.8\)](#) can be related to those of pure components by the following relationship:

$$\left(b - \frac{a}{RT} \right)_{ij} = \frac{\left(b_i - \frac{a_i}{RT} \right) + \left(b_j - \frac{a_j}{RT} \right)}{2} (1 - A_{ij} - B_{ij} T) \quad (2.30)$$

The Helmholtz free energy departure function is the difference between the molar Helmholtz free energy of pure species i and the ideal gas at constant P and T.

$$A_i(T, P) - A_i^{IG}(T, P) = \left(- \int_{v=\infty}^{v_i} P dv \right) - \left(- \int_{v=\infty}^{\frac{RT}{P}} \frac{RT}{v} dv \right) \quad (2.31)$$

The expression for A^e is derived using lattice models and therefore assumes that there are no free sites on the lattice. This assumption can be approximated to the assumption that there is no free volume. Thus for the equation of state:

$$\begin{aligned}\lim_{P \rightarrow \infty} v_i &= b_i \\ \lim_{P \rightarrow \infty} v_{mix} &= b_{mix}\end{aligned}\quad (2.32)$$

b_{mix} can be approximated by the following:

$$b_{mix} = \frac{\sum_i \sum_j x_i x_j \left(b - \frac{a}{RT} \right)_{ij}}{1 + \left(\frac{A_{\infty}^e(x)}{RT} \right) - \sum_i x_i \left(\frac{a_i}{b_i RT} \right)} \quad (2.33)$$

therefore a_{mix} is:

$$\frac{a_{mix}}{b_{mix}} = \sum_i x_i \frac{a_i}{b_i} - A_{\infty}^e(x) \quad (2.34)$$

and $F(x)$ is:

$$F(x) = \sum_i x_i \frac{a_i}{b_i} - A_{\infty}^e(x) \quad (2.35)$$

The Helmholtz free energy, $A_{\infty}^e(x)$, is calculated using the NRTL model. You are required to supply the binary coefficient values on the parameters matrix when the Cij/NRTL radio button is selected. Note that the α term is equal to 0.3.

Equation of State Interaction Parameter

This information applies to the following Property Packages:

- Kabadi Danner
- Lee-Kesler Plocker
- PR
- PRSV
- Soave Redlich Kwong, SRK
- Sour PR
- Sour SRK
- Zudkevitch Joffe

The Equation of State Interaction Parameters group is shown below for a selected EOS property package as displayed on the Binary Coeffs tab using an EOS, as displayed on the Binary Coeffs tab when an EOS is the selected property package, is shown below.

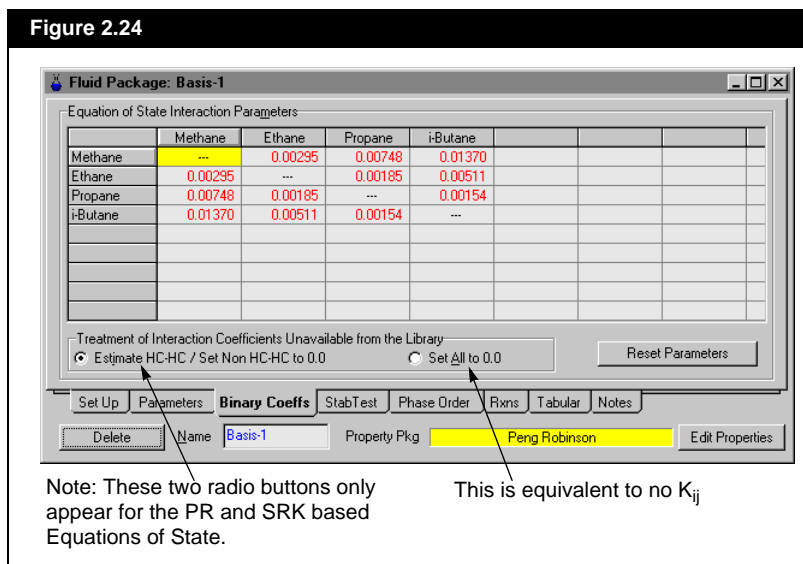

The numbers displayed in the table are initially calculated by HYSYS, but you can modify them. All known binary interaction parameters are displayed, with unknowns displayed as dashes (---). You have the option of overwriting any library value.

For all Equation of State parameters (except PRSV), $K_{ij} = K_{ji}$, so when you change the value of one of these, both cells of the pair automatically update with the same value. In many cases, the library interaction parameters for PRSV do have $K_{ij} = K_{ji}$, but HYSYS does not force this if you modify one parameter in a binary pair.

If you are using PR or SRK (or one of the Sour options), two radio buttons are displayed at the bottom of the tab.

Radio Button	Description
Estimate HC-HC/Set Non HC-HC to 0.0	This radio button is the default selection. HYSYS provides the estimates for the interaction parameters in the table, setting all non-hydrocarbon pairs to 0.
Set All to 0.0	When this is selected, HYSYS sets all interaction parameter values in the table to 0.0.

Activity Model Interaction Parameters

This information applies to the following property packages:

- Chien Null
- Extended NRTL
- General NRTL
- Margules
- NRTL
- UNIQUAC
- van Laar
- Wilson

The Activity Model Interaction Parameters group, as displayed on the Binary Coeffs tab when an Activity Model is the selected property package, is shown in the figure below.

Figure 2.25

The numbering and naming of the radio buttons selections vary according to the selected Activity Model.

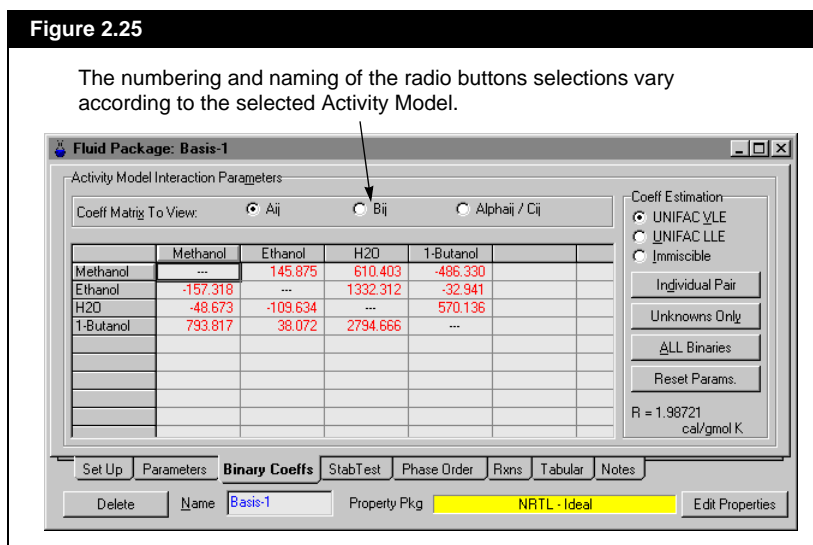

You may reset the binary parameters to their original library values by clicking the Reset Params button.

The interaction parameters for each binary pair are displayed; unknown values will show as dashes (---). You can overwrite any value or use one of the estimation methods. The estimation methods are described in the following section.

To display a different coefficient matrix (i.e., B_{ij}), select the appropriate radio button.

Estimation Methods

Since the Wilson equation does not handle three phase systems, the Coeff Estimation group does not show the UNIFAC LLE or Immiscible radio buttons when this property package is used.

$\text{Alpha}_{ij} = \text{Alpha}_{ji}$, but
 $\text{A}_{ij} \neq \text{A}_{ji}$.

UNIFAC estimations are by default performed at 25 °C, unless you change this value on the Set Up tab.

You may reset the binary parameters to their original library values by clicking the Reset Params button.

When using Activity Models, HYSYS provides three interaction parameter estimation methods. Select the estimation method by selecting one of the following radio buttons and then invoke the estimation by selecting one of the available buttons:

Button	Description
UNIFAC VLE	HYSYS calculates parameters using the UNIFAC VLE model.
UNIFAC LLE	HYSYS calculates all parameters using the UNIFAC LLE model.
Immiscible	The three buttons used for the UNIFAC estimations are replaced by the following: <ul style="list-style-type: none"> • Row in Clm Pair. Use this button to estimate the parameters such that the row component (j) is immiscible in the column component (i). • Clm in Row Pair. Use this button to estimate parameters such that the column components (j) are immiscible in the row components (i). • All in Row. Use this button to estimate parameters such that both components are mutually immiscible.

If you have selected either the UNIFAC VLE or UNIFAC LLE estimation method, you can apply it in one of the following ways, by selecting the appropriate button:

Button	Description
Individual Pair	This button is only visible when UNIFAC VLE is selected. It calculates the parameters for the selected component pair, A_{ij} and A_{ji} . The existing values in the matrix are overwritten.
Unknowns Only	If you delete the contents of cells or if HYSYS does not provide defaults values, you can use this option and have HYSYS calculate the activity parameters for all the unknown pairs.
All Binaries	Recalculates all the binaries in the matrix. If you had changed some of the original HYSYS values, you can use this to have HYSYS re-estimate the entire matrix.

2.4.4 Stability Test Tab

The stability test can be thought of as introducing a "droplet" of nucleus into the fluid. The droplet then either grows into a distinctive phase or is dissolved in the fluid.

For multi-phase fluids, there exist multiple false calculated solutions. A false solution exists when convergence occurs for a lower number of phases than exists in the fluid. For example, with a three-phase fluid, there is the correct three-phase solution, at least three false two-phase solutions and multiple false single-phase solutions. A major problem in converging the flash calculation is arriving at the right solution without a prior knowledge of the number of equilibrium phases.

The Stability Test allows you to instruct HYSYS on how to perform phase stability calculations in the Flowsheet. If you encounter situations where a flash calculation fails or you are suspicious about results, you can use this option to approach the solution using a different route.

The strategy used in HYSYS is as follows: unless there is strong evidence for three phases, HYSYS first performs a two-phase flash. The resulting phases are then tested for their stability.

Figure 2.26

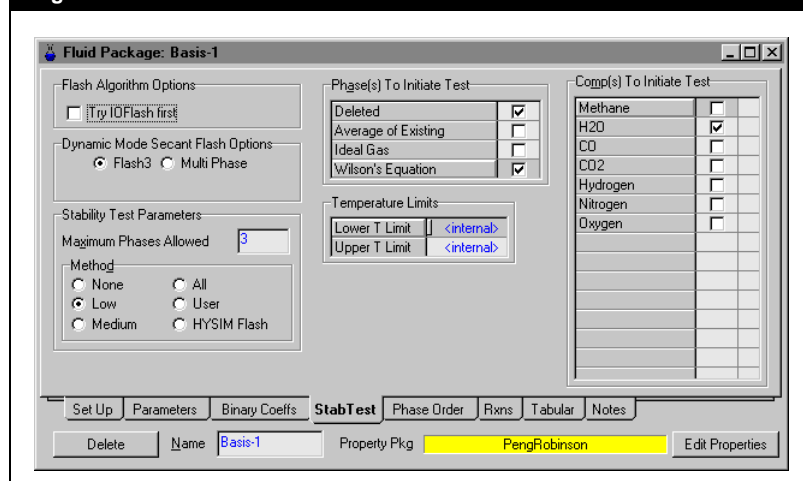

Dynamic Mode Flash Options Group

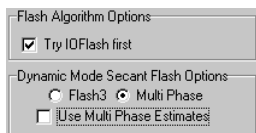

If the IOFlash fails, HYSYS will immediately go to method selected in the Secant Flash Options group.

HYSYS enables you to modify the flash calculation methods to be used. There are three setting options available:

Flash Option	Description
Try IOFlash first	This activates an alternative optimized Inside-Out flash algorithm that may provide a significant speed improvement in many cases. It is aimed at dynamics mode, but operates in steady state mode as well. The flash can handle rigorous three phase calculations using the Stability Test Parameters settings, although it is not tested as well as the default flash algorithms and does not work with all property packages. If you experience problems that are flash related, try selecting or deselecting the option. For maximum speed in two phase systems, you can also set the Maximum Phases Allowed for the fluid package to two in the Stability Test Parameters group, or set the Method to none to disable the test.
The remaining options are for the dynamic mode secant flash options.	
Flash3	This is the default secant flash algorithm used in dynamics mode. It is fast, but does not perform rigorous phase stability tests based on the option set in the Stability Test Parameters group. Hence, it may not always detect a second liquid phase when it is present.
Multi Phase	This is a secant flash algorithm that performs phase stability testing according to the settings in the Stability Test Parameters group. This option is typically slower than the flash3 option. It can be used when multiple liquid phases are important or in rare cases where using the flash3 option results in instabilities due to the second liquid phase not being detected consistently.
Use Multi Phase Estimates	The checkbox becomes available when you select Multi Phase as the Secant Flash Option. If the case consist of three phases, estimates are passed to the flash which speeds up some flashes.

COMThermo is not optimized for dynamics mode and may result in performance issues if used in dynamics mode.

If the IOFlash option is selected, the Pressure Flow Solver group on the Dynamics page of the Preferences options allows the flash to be solved simultaneously with heat transfer equations. The option can result in a further significant speed increase, but should only be used if the case is stable using IO.

If a dynamics case has more than one liquid phase (or if a single liquid phase is aqueous or a hydrocarbon), it is recommended that you use the Phase Sorting Method for the fluid package on the [Section 2.4.5 - Phase Order Tab](#). By default, phases are sorted on density and phase types. If the phase type changes, instabilities may result. The Phase Sorting Methods allow you to clearly define the order in which phases should be defined so that they are consistent.

Stability Test Parameters Group

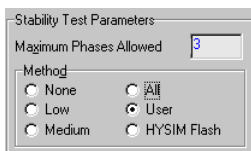

You can specify the maximum number of phases allowed (2 or 3) in the Maximum Phases Allowed input cell. If this value is set to 2, the stability test quits after 2-phase flashes. Occasionally, you may still get 3 phases, as the flash may attempt to start directly with the 3-phase flash.

The Stability scheme used is that proposed by Michelson. In the Method group, you can select the method for performing the stability test calculations by selecting one of the following radio buttons:

Radio Button	Description
None	No stability test is performed.
Low	Uses a default set of Phases/Components to Initiate the Stability Test. This method includes the Deleted phases (if they exist), the Wilson's Equation initial guess and the Water component (if it exists) in the fluid.
Medium	In addition to the options used for the Low method, this method also includes the Average of Existing phase, the Ideal Gas phase and the heaviest and lightest components in the fluid.
All	All available Phases and Components are used to initiate the test.
User	Allows you to activate any combination of checkboxes in the Phase(s) to Initiate Test and Comp(s) to Initiate Test groups. If you make changes when a default Method radio button (i.e., Low, Medium) is selected, the method will be changed to User automatically.
HYSIM Flash	This is the flash method used in HYSIM. If this choice is selected, HYSYS will use the same flash routines as in HYSIM and no stability test will be performed. This option allows comparison of results between HYSIM and HYSYS. This stability option is not recommended for dynamics mode. Use the default flash3 option with the stability parameter set to none.

Phases to Initiate Test

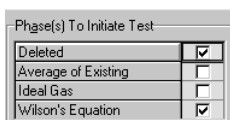

There are four choices listed within the Phase(s) to Initiate Test group. These checkboxes are activated according to the radio button selection in the Method group. If you change the status of any option, the radio button in the Method group is automatically set to User.

Checkboxes	Description
Deleted	If a phase is removed during the 2-phase flash, a droplet of the deleted fluid is re-introduced.
Average of Existing	The existing equilibrium fluids are mixed in equal portions; a droplet of that fluid is introduced.

One limitation with the stability test is the fact that it relies on the property package chosen rather than physical reality. At best, it is as accurate as the property package. For instance, the NRTL package is known to be ill-behaved in the sense that it could actually predict numerous equilibrium phases that do not exist in reality. Thus, turning on all initial guesses for NRTL may not be a good idea.

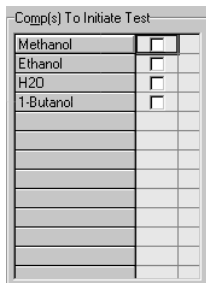
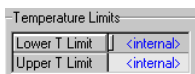

Checkboxes	Description
Ideal Gas	A small amount of ideal gas is introduced.
Wilson's Equation	A hypothetical fluid is created using the Wilson's K-value and is used to initiate the stability test.

If any one of these initiating nuclei (initial guesses) forms a distinctive phase, the existing fluid is unstable and this nucleus provides the initial guess for the three-phase flash. If none of these initial guesses shows additional phases, it can only be said that the fluid is likely to be stable.

Temperature Limits

The temperature limits are intended to be used in dynamics mode and are set to stop the flash when the limits are attained. If the limits are reached, then dynamics will extrapolate thereafter. The limits avoid potential problems with some property packages at low temperatures and during severe process upsets where you would get numerical errors and heat exchanger convergence problems.

Components to Initiate Test

When a "droplet" of nucleus is introduced into the fluid, the droplet either grows into a distinctive phase or is dissolved in the fluid. Another obvious choice for the droplet composition is one of the existing pure components. For example, if the fluid contains hexane, methanol and water, one could try introducing a droplet of hexane, a droplet of methanol or a droplet of water. The choices for the pure component "droplets" are listed in the Comp(s) to Initiate Test group.

2.4.5 Phase Order Tab

Refer to [Section 3.1 - Material Stream Property View](#) of the **Operations Guide** for more information on stream properties.

The Phase order feature is intended for dynamics. HYSYS dynamics always uses three phases for streams and fluids in the stream property view. For each unit operation, dynamics also assumes that the same material is in the same phase slot for all of the connected streams. The order of the first phase is always vapour and the second phase is liquid. The third phase may be aqueous or it can be a second liquid phase.

By default, HYSYS sorts these phases based on their Type (liquid or aqueous) and Phase Density. However, subtle changes to the stream properties may change the order. Stream properties displayed as a liquid phase in one instance may be displayed as an aqueous phase in another. For example, inside a tray section the composition of a phase may change so that instead of being aqueous it is a liquid phase. The phase moves to a different slot in the fluid. This can cause disturbances in dynamics mode. The Phase Sorting Method includes two options and is shown below.

Figure 2.27

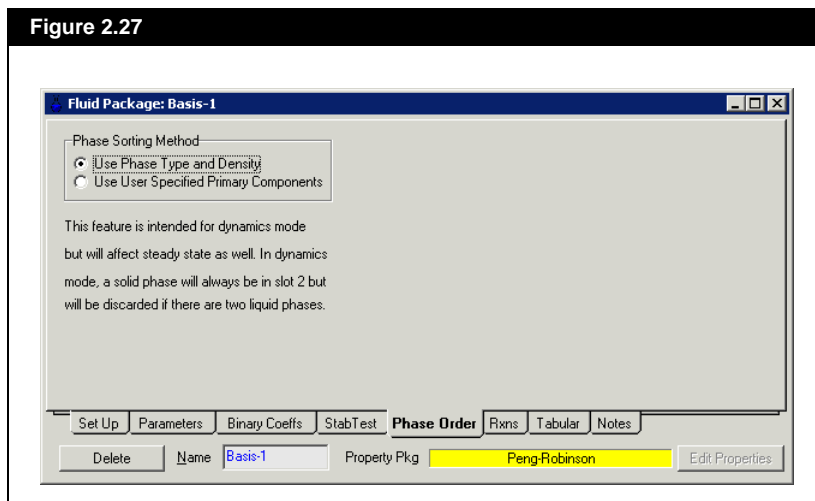

Use Phase Type and Density

This option changes the order of phases in steady state as well. Although in steady state many of the calculations depend on the phase type and not the order, and hence should not have any significant impact.

This option can cause instabilities in dynamics. In practice if small spikes are identified and an examination of the flowsheet reveals that some material appears in different phase slots in different parts of the flowsheet (where the spikes originate) than the user specified option is recommended.

Use User Specified Primary Components

The Use User Specified Primary Components option displays the Select Primary Phase Components group that allows you to specify which components should be in phase slot 1 and which components should be in phase slot 2. These checks are used to determine the phase order wherever the fluid package in question is used.

If there is only one non-vapour phase present and the mole fractions of the primary component adds up to more than the specified threshold, it is considered to belong in phase slot 1 and of type “liquid 1”. Otherwise the ratio of primary component for the two choices is examined.

Changing this option does not resolve the case or immediately update the affected streams. The changes occur while the integrator is running, which minimizes disturbances.

This option is recommended when:

- a simulation is performed and it has more than one liquid phase.
- the densities of the two liquid phases may be close.
- one or more phases is close to being labelled either aqueous or liquid.

2.4.6 Reactions Tab

See [Chapter 5 - Reactions](#) for more information.

Within the Basis Environment, all reactions are defined through the Reaction Manager (Reactions tab of the Simulation Basis Manager). On the Rxns tab of the Fluid Package property view, you are limited to attaching/detaching reaction sets.

Figure 2.28

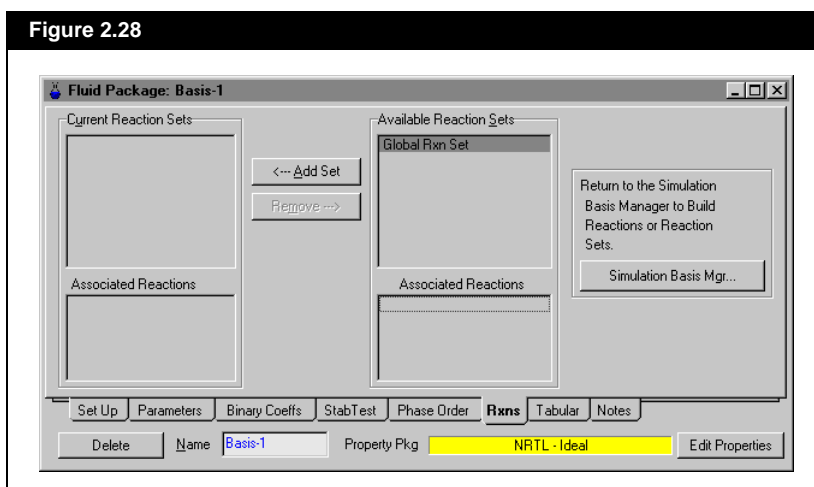

The objects for the Rxns tab within the Fluid Package property view are described below.

Object	Description
Current Reactions Sets	This lists all the currently loaded reactions set in this Fluid Package.
Associated Reactions	There are two Associated Reactions list boxes. Both boxes displays all the reactions associated with the respective selected Reaction Set.
Add Set	This button attaches the highlighted Available Reaction Set to the Fluid Package and displays it in the Current Reactions Sets group.
Remove	This button removes the highlighted Current Reaction Set from the Fluid Package.
Available Reactions Sets	This list-box displays all the Available Reactions Sets in the case.
Simultaneous Basis Mgr	Click this button to access the Reaction Manager.

2.4.7 Tabular Tab

The Tabular Package can regress the experimental data for select thermophysical properties such that a fit is obtained for a chosen mathematical expression. The Tabular Package is utilized in conjunction with one of the HYSYS property methods. Your targeted properties are then calculated as replacements for whatever procedure the associated property method would have used.

Although the Tabular Package can be used for calculating every property for all components in the case, it is best used for matching a specific aspect of your process. A typical example would be in the calculation of viscosities for chemical systems, where the Tabular Package will often provide better results than the Activity Models.

HYSYS contains a default library containing data for over 1,000 components.

Tabular Package calculations are based on mathematical expressions that represent the pure component property as a function of temperature. The values of the property for each component at the process temperature are then combined, using the stream composition and mixing rule that you specify.

The Tabular provides access to a comprehensive regression package. This allows you to supply experimental data for your components and have HYSYS regress the data to a selected expression. Essentially, an unlimited number of expressions are available to represent your property data. There are 32 basic equation shapes, 32 Y term shapes, 29 X term shapes, as well as Y and X power functions. The Tabular provides plotting capabilities to examine how well the selected expression predicts the property. You are not restricted to the use of a single expression for each property. Each component can be represented using the best expression.

Whenever experimental data is supplied, it is retained in the memory by HYSYS and stored in the case.

You may not need to supply experimental data to use the Tabular. If you have access to a mathematical representation for a component/property pair, you can simply select the correct equation shape and supply the coefficients directly. Further, HYSYS provides a data base for nearly 1,000 library components, so you can use this information directly within the Tabular without supplying any data whatsoever.

The **PPDS** database is an optional tabular feature. Contact your Hyprotech representative for further information.

In addition, HYSYS can directly access the information in the PPDS database for use in the Tabular. This database is similar to that provided with HYSYS in that the properties for the components are represented using a mathematical expression.

The Heat of Mixing property can be applied in one of two manners. For Activity Models that do not have Heat of Mixing calculations built in, this allows you to supply data or have the coefficients estimated, and have Heats of Mixing applied throughout the flowsheet. Equations of State do account for Heat of Mixing in their enthalpy calculations, however, in certain instances predict the value incorrectly. You can use this route to apply a correction factor to the Equation of State.

In the cases where the Equation of State is predicting too high a value, implementing a negative Heat of Mixing can correct this.

Requirements for Using the Tabular

There are only two requirements on the usage of the Tabular package. First, most properties require that all components in the case have their property value calculated by the Tabular. Second, enthalpy calculations require that the Tabular be used for both the liquid and vapour phase calculations. Similarly, you may use only one enthalpy type property for each phase. For example, liquid enthalpy and liquid heat capacity cannot both be selected. An extension to this occurs when the latent heat property is selected. When this property is activated, only one enthalpy type property or one heat capacity property may be selected.

Limits in the Tabular Option

In enthalpy extrapolation, if the upper temperature limit (T_{\max}) is less than the critical temperature (T_c) HYSYS Tabular option continues to extrapolate the data based on the original curve up to the critical point. At this point, an internal extrapolation method is used to calculate the liquid enthalpy. Due to the internal extrapolation method, there may be a huge discontinuity and poor extrapolation results from T_{\max} to T_c . The poor calculated values cause problem with the PH flash calculation.

There are two methods to avoid this problem:

- Increase the T_{\max} value of the original enthalpy curve. However, as mentioned above the curve itself does not extend above T_{\max} very well and produces poor results. You will have to be responsible for changing the curve shape to extrapolate in a better manner.
- Use the Enthalpy Model T_r Limit option. This option allows you to control the starting temperature at which the extrapolation method is implemented. So instead of T_c , the extrapolation will start at a certain T_r (the default value is 0, which tells HYSYS to use the default method) typically 0.7 to 0.99.

Extrapolating accurate/adequate data is important, especially for enthalpy values approaching the critical point, as the values can change in odd manner and may require special extrapolation.

If you are not using PPDS mixing rules (PPDS extrapolation methods) HYSYS supplies a very simple extrapolation based on constant C_p calculated from the original tabular enthalpy curve. This method keeps everything monotonically increasing through the critical point and into the dense phase.

Using the Tabular Package

When using the Tabular package a general sequence of steps is shown below:

1. Enable the Options, **Configuration** and **Notes** pages by checking the **Enable Tabular Properties** checkbox.

Figure 2.29

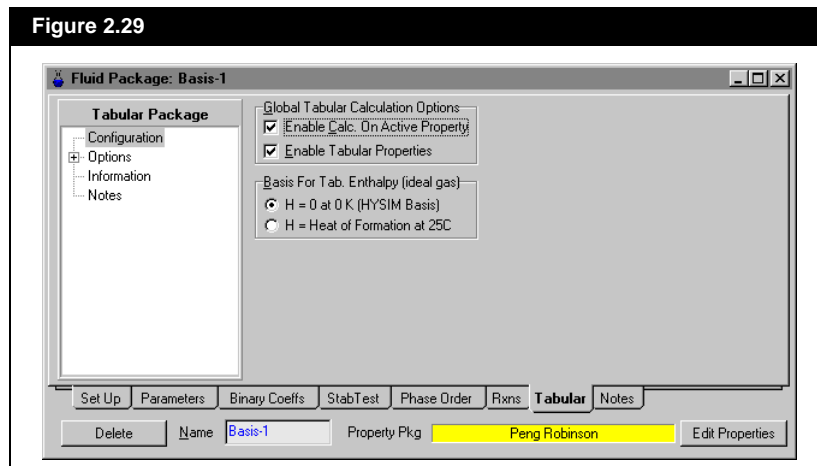

2. Select the **Basis for Tabular Enthalpy** by clicking the appropriate radio button on the **Configuration** page.
3. Select the checkboxes for the desired target properties from the All Properties, Physical and Thermodynamic pages in the Options tree configuration. The **All Properties** page is shown below.

To view all pages under the options, use the "+" to expand the tree.

Figure 2.30

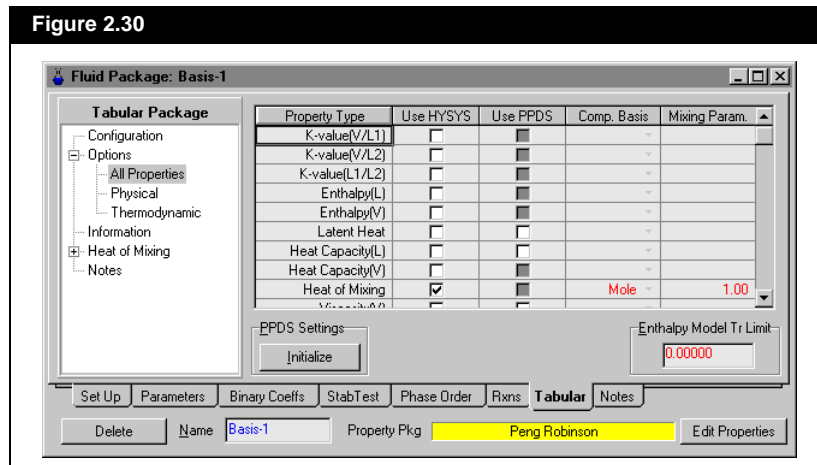

As properties are added, the Information tree also becomes expandible. This may be done by clicking on the “+” that appears in front of the Information label. Expanding this tree displays all of the active target properties selected on the Options pages. If the Heat of Mixing property is activated on the All Properties or Thermodynamics page, a new expandible tree for Heat of Mixing appears in the Tabular Package group.

4. If you have the PPDS database, click the checkbox for the database.
5. Once a target property is selected on one of the three Options pages, you may select the **Mixing Basis** by using the drop-down list. The Parameter value may also be changed on this page.
6. To view the existing library information, you must first select the desired page from the expandible Information tree. Click the desired property from the tree list.

Figure 2.31

The screenshot shows the 'Fluid Package: Basis-1' window. On the left is a tree view with 'Heat of Mixing' expanded. The main area contains a table with columns for Methane, Ethane, Propane, and i-Butane. Below the table are input fields for 'X Shape' and 'Equation', and buttons for 'Cmp. Plots' and 'Cmp. Prop. Detail'. At the bottom, there are tabs for 'Set Up', 'Parameters', 'Binary Coeffs', 'StabTest', 'Phase Order', 'Rxnns', 'Tabular', and 'Notes'. The 'Name' field is 'Basis-1' and the 'Property Pkg' is 'Peng Robinson'.

	Methane	Ethane	Propane	i-Butane
Use Table	<input checked="" type="checkbox"/>	<input checked="" type="checkbox"/>	<input checked="" type="checkbox"/>	<input checked="" type="checkbox"/>
Equation Shape	Poly1	Poly1	Poly1	Poly1
Y Shape	Yvar	Yvar	Yvar	Yvar
Y Coefficient	1.000	1.000	1.000	1.000
Y Shape Norm	1.000	1.000	1.000	1.000
X Shape	X	X	X	X
X Coefficient	1.000	1.000	1.000	1.000
X Shape Norm	190.7	305.4	369.9	408.1
Eqn. Xmin [K]	<empty>	<empty>	<empty>	<empty>
Eqn. Xmax [K]	<empty>	<empty>	<empty>	<empty>

X Shape: x
Equation: $Y = a + bX + cX^2 + dX^3 + eX^4$
Y Shape: y

Buttons: Cmp. Plots, Cmp. Prop. Detail

Tabs: Set Up, Parameters, Binary Coeffs, StabTest, Phase Order, Rxnns, **Tabular**, Notes

Delete Name: Basis-1 Property Pkg: Peng Robinson Edit Properties

- To plot the existing library information, click the **Cmp Plots** button. Click a component using the drop-down list in the Curve Selection group to change the components being plotted. The variables, Enthalpy vs. Temperature are plotted from the Variables group and shown in the figure below.

Figure 2.32

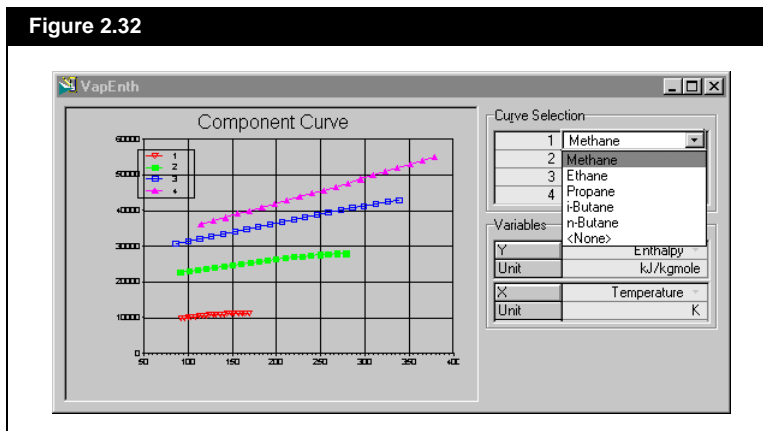

- Return to the **Information** page of the property by closing the plot view. To view the PropCurve property view for a selected component, highlight a value in the column of the desired component and click the **Cmp Prop Detail** button.

Figure 2.33

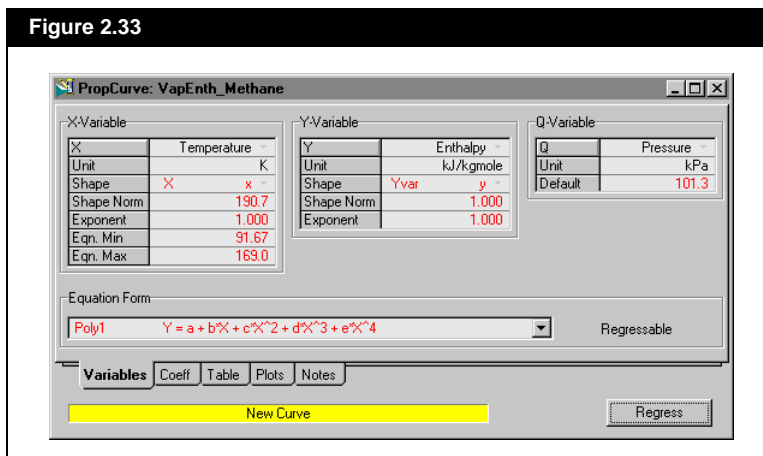

- Set the Equation Form and supply data. You can view this same format of data for library components.

The Tabular tab of the fluid package property view contains two pages and three trees of information, which are displayed at different times depending on the options selected. These pages are:

- Configuration Page
- Options Tree
- Information Tree
- Heat of Mixing Tree (appears only when Heat of Mixing is activated in the Options)
- Notes

Configuration Page

The configuration page consists of two groups, the Global Tabular Calculation Options, and the Basis for Tab. Enthalpy (ideal gas).

Figure 2.34

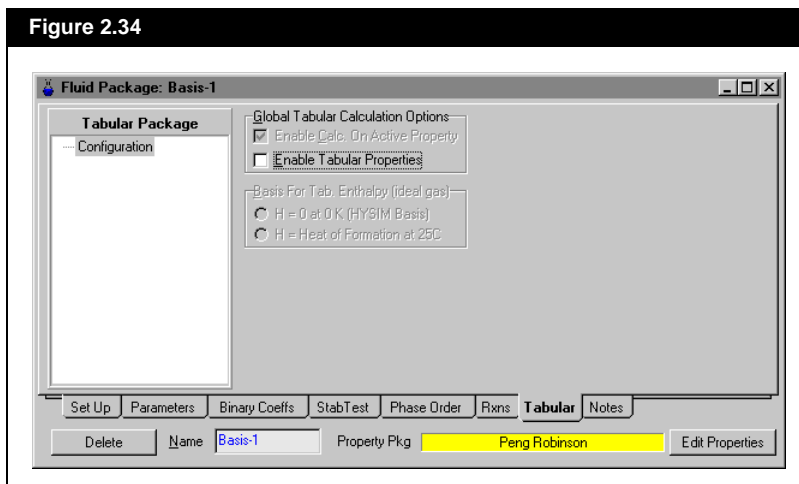

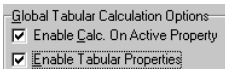

Activating the Enable Tabular Properties checkbox will make the Options tree, Information tree, and Notes page available.

Global Tabular Calculation Behaviour Group

The Global Tabular Calculation Behaviour Group contains two checkbox options:

Checkbox	Description
Enable Calculation of Active Properties	If this is activated, all the selected Active Properties are calculated via the Tabular Package. If this checkbox is not activated, all properties are calculated by the Property Package. This provides a master switch to enable/disable the Tabular Package while retaining the Active Property selections.
Enable Tabular Properties	Toggles the Tabular Properties on or off. If the checkbox is toggled off, no other pages are available and none of the previously inputted data is stored.

Please note the difference between the Enable Calculation of Active Properties and the Enable Tabular Properties checkboxes. The Enable Calculation of Active Properties checkbox toggles between the properties regressed from the data supplied on the Tabular tab and the default values calculated by the Property Package. While deactivating the checkbox returns to the default Property Package values, the tab retains all inputted data for the active property selections.

The Enable Tabular Properties checkbox makes the other pages active for specification. Deactivating this checkbox purges the tab of any tabular property data it might have previously contained.

Basis for Tabular Enthalpies

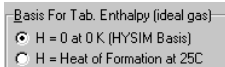

This group becomes active after the Enable Tabular Properties checkbox is clicked. It allows you to select between the enthalpy basis for tabular calculations:

- H = 0 K, ideal vapour (HYSIM basis)
- H = Heat of formation at 25 °C, ideal vapour

Options Tree Configuration

You can target a property through the three pages available in the Options tree. To expand the tree, click the “+” in front of the Options label in the Tabular Package group. This allows the All Properties, Physical, and Thermodynamics pages to be visible. Each one of these pages consists of a five column matrix table.

Figure 2.35

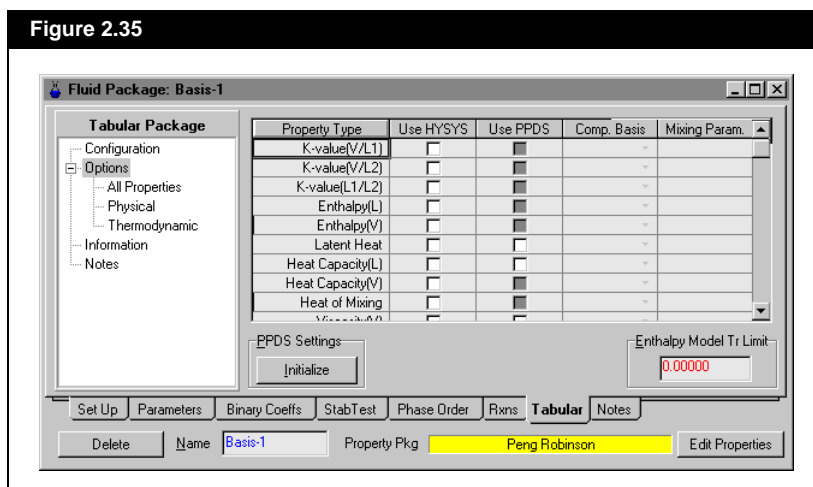

Property Type

The All Properties page consists of seventeen properties which include both the Physical and Thermodynamic properties. These properties have then been subdivided into two groups and displayed again on either the Physical or Thermodynamics page. These properties are listed in the table below, along with the subgroup that they belong to:

- K-value (V/L1)[*Thermodynamic*]
- K-value (V/L2)[*Thermodynamic*]
- K-value (L1/L2)[*Thermodynamic*]
- Enthalpy(L)[*Thermodynamic*]
- Enthalpy(V)[*Thermodynamic*]
- Latent Heat[*Thermodynamic*]
- Heat Capacity(L)[*Thermodynamic*]
- Heat Capacity(V)[*Thermodynamic*]
- Heat of Mixing[*Thermodynamic*]
- Viscosity (L)[*Physical*]

- Viscosity (V)[Physical]
- Thermal Cond (L)[Physical]
- Thermal Cond (V)[Physical]
- Surface Tension[Physical]
- Density (L)[Physical]
- Entropy(L)[Thermodynamic]
- Entropy(V)[Thermodynamic]

Use HYSYS/Use PPDS

The PPDS database is an optional tabular feature. Contact your Hyprotech representative for further information.

The checkboxes in the Use HYSYS and Use PPDS columns allow you to select between the Hyprotech and the PPDS libraries. Depending on the property type selected, the PPDS library may not be available. When the PPDS library is available, the checkbox changes from light grey to white.

Composition Basis

The Composition Basis allows you to select the Basis (mole, mass, or liq volume) on which the mixing rule is applied. When you select a property type the Composition Basis becomes active for that property. The available options can be accessed from the drop-down list within the cell of each property selected.

The default mixing rule which is applied when calculating the overall property is shown in the following form:

$$Property_{mix} = \left[\sum_i x_i Property_i^f \right]^{\frac{1}{f}} \quad (2.36)$$

Mixing Parameter

The last column in the matrix table is the Mixing Parameter. This allows you to specify the coefficient (f) to use for the mixing rule calculations. Notice that the default value is 1.00. The value that HYSYS uses as the default is dependent on the property selected. For instance, if you select Liquid Viscosity as the property type, HYSYS uses 0.33 as the default for the Mixing Parameter.

If you are using the PPDS database, you can modify the mixing rule parameters for any property with the exception of the vapour viscosity and vapour thermal conductivity. The parameters for these properties are set internally to the appropriate PPDS mixing rule.

Information Tree Configuration

It is important to note that the Heat of Mixing property does not create a page in the Information tree. Instead it will create a unique tree in the Tabular Package group.

After properties are activated on one of the three pages in the Options tree, the property appears in the Information tree. This tree may be expanded by clicking the “+” in front of the Information label in the Tabular Package group.

Figure 2.36

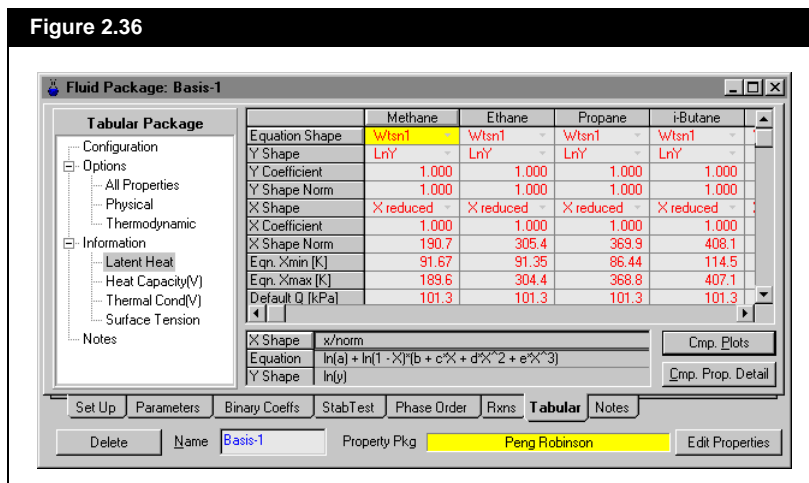

A component may be targeted by clicking in any cell in the component's column. For example, if Propane was the component of interest, click in any cell in the third column. Once the component is targeted, select the Cmp Prop Detail button to access the PropCurve view. Most of the information contained in the PropCurve view is displayed on the Information pages and can also be changed there.

See [Supplying Tabular Data](#) for further information on the PropCurve view.

Cmp Plots Button

The Cmp Plot button accesses the plot of Temperature vs. the selected Property Type. The Variables group shows the property used for the X and Y axis (Enthalpy in this case).

Figure 2.37

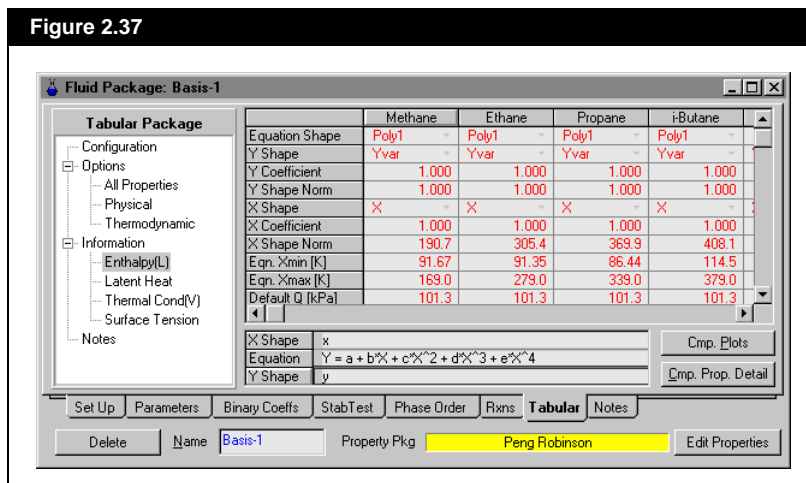

Object inspect the plot area to access the Graph Control view. Refer to [Section 10.4 - Graph Control](#) of the [User Guide](#) for more information.

HYSYS can only plot four curves at a time. The Curve Selection group lists the components which are plotted on the graph. The default is to plot the first four components in the component list. You can replace the default components in the Curve Selection group with other components by using the drop-down list in each cell.

Select the component you want to add to the Curve Selection group. The new component replaces the previously selected component in the Curve Selection group, and HYSYS redraws the graph, displaying the data of the new component.

HYSYS uses the current expressions to plot the graphs, either from the HYSYS library or your supplied regressed data.

Heat of Mixing Tree

When the Heat of Mixing property is activated on either the All Properties or the Thermodynamic page in the Options tree, a new tree gets added to the root of the tree in the Tabular Properties group. This tree may be expanded by pressing the “+” in front of the Heat of Mixing label in the tree. The pages in the tree correspond to the components in the fluid package.

Figure 2.38

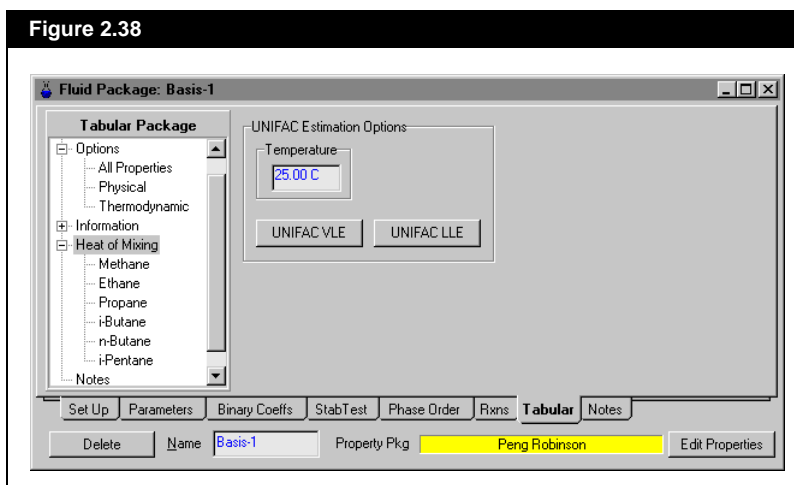

Heat of Mixing Page

This page is only visible when Heat of Mixing is selected on the All Properties or Thermodynamic pages. It consists of the following objects:

Object	Description
UNIFAC VLE	HYSYS uses the UNIFAC VLE estimation method to calculate the binary coefficients. This overwrites any existing coefficients.
UNIFAC LLE	Same as UNIFAC VLE, except the LLE estimation methods are used.
Temperature	The reference temperature at which the UNIFAC parameters are calculated.

Composition Pages

The Composition pages in the Heat of Mixing tree are very similar to the pages contained in the Information tree. Click the View Details button to access a modified PropCurve view.

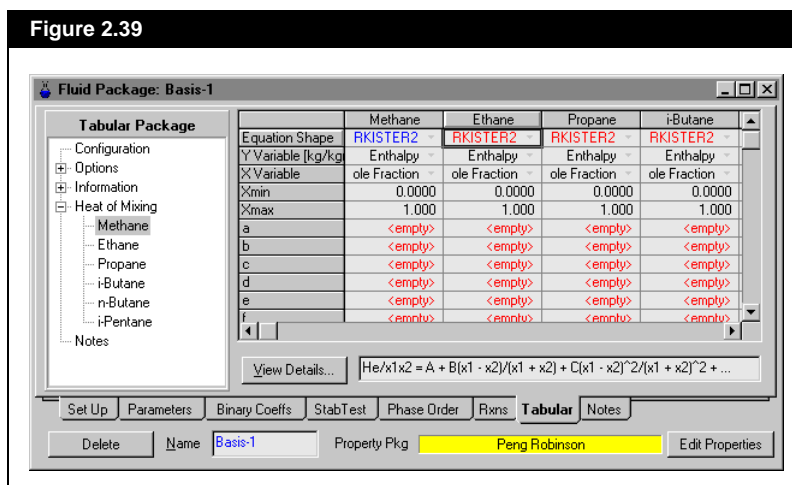

See [Supplying Tabular Data](#) for further information on the PropCurve view.

The only difference is that there is no Coeff tab. Most of the information contained in the PropCurve view is displayed on the Information pages, where it can be modified.

Notes Page

Any comments regarding the tabular data or the simulation in general may be displayed here.

Supplying Tabular Data

When you have specified the flowsheet properties for which you want to use the Tabular Package, you can change the data HYSYS uses in calculating the properties. HYSYS contains a data file with regressed coefficients and the associated equation shape, for most components.

To illustrate the method of supplying data, use Methane as a component and Liquid Enthalpy as the Property. From the Enthalpy (L) Tabular Package group, select the Methane cell as the component and click the Cmp. Prop. Detail button. The Variables tab of the PropCurve view is displayed as shown below:

If Heat of Mixing is used, you can access the Prop Curve by selecting the component and then click the View Details button. Although it should be noted that this view does not include the Coeffs tab.

Figure 2.40

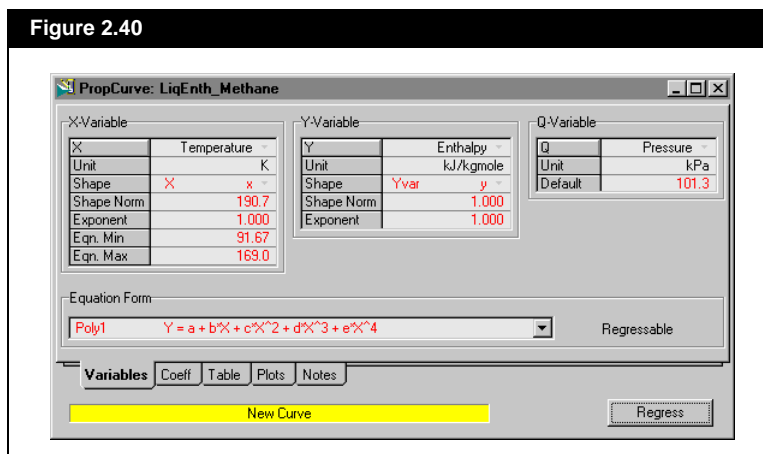

The PropCurve property view contains the following tabs:

Tab	Description
Variables	Specify the equation shapes and power functions for the property.
Coeff	Displays the current coefficients for the selected equation.
Table	Current tabular data for the property (library or user supplied).
Plots	Plots of the property using the tabular data and the regressed equation.
Notes	User supplied descriptive notes for the regression.

Variables Tab

The Variables tab is the first tab of the PropCurve property view. It contains four groups, X-Variable, Y-Variable, Q-Variable, and Equation Form. The Variables tab is shown in the previous figure.

X-Variable Group

This group contains information relating to the X-Variable and is described below.

Cells	Description
X	Since all properties are measured versus Temperature, this cell always shows Temperature when using the Tabular Package.
Unit	Displays the units for the temperature values. You cannot change the units here. The HYSYS internal units for Temperature, K, are always used.
Shape	This is the shape of the X variable. The choices for the X Shape can be accessed using the drop-down list in the cell. There are 29 available shapes. Use the scroll bar to move through the list. In this case, the shape selected is Xvar:x . This means that the X variables in the equation are equal to X, which represents temperature. If <i>LogX:log10(x)</i> is selected as the X Shape, then the X variables in the equation are replaced by <i>log10(x)</i> .
Shape Norm	This is a numerical value used in some of the X Shapes. In the drop-down list for X Shape, notice that the second choice is <i>Xreduced:x/norm</i> . The <i>x/norm</i> term, where <i>norm = 190.70</i> , replaces the X variable in the equation. You can change the numerical value for Norm in the cell.
Exponent	Allows you to apply a power term to the X term, for example, $X^{0.5}$.
Eqn Minimum	Defines the minimum boundary for the X variable. When a flowsheet calculation for the property is outside the range, HYSYS uses an internal method for extrapolation of the curve. This method is dependent on the Property being used. See the Equation Form section.
Eqn Maximum	Defines the maximum boundary for the X variable. When a flowsheet calculation for the property is outside the range, HYSYS uses an internal method for extrapolation of the curve. This method is dependent on the Property being used. See the Equation Form section.

Y-Variable Group

This group contains all information relating to the Y-Variable.

Cells	Description
Y	This is the property chosen for Tabular calculations.
Unit	Displays the units for the Y variable. You cannot change the units here, it must be done through the Basis Manager (Preferences option).
Shape	This is the shape of the Y variable. The choices for the Y Shape are available using the drop-down list within the cell. There are 32 shapes selected. Use the scroll bar to move through the list. In this case, the shape chosen is Yvar:y. This means that the Y variables in the equation are equal to Y, which represents enthalpy. If <i>LogY:log10(y)</i> is chosen as the Y Shape, then the Y variables in the equation are replaced by <i>log10(y)</i> .
Shape Norm	This is a numerical value used in some of the Y Shapes. In the drop-down list for Y Shape, notice that the second choice is <i>Yreduced:y/norm</i> . The Y variable in the equation is replaced by the <i>y/norm</i> value. This numerical value can be changed within the cell.
Exponent	Allows you to apply a power term to the Y term, for example, $Y^{0.5}$.

Q-Variable Group

This group contains all information relating to the Q Variable. This Variable is used in some of the X and Y Variable equations.

Cell	Description
Q	Represents the Q variable which is always Pressure.
Unit	Displays the units for the Q Variable, which are always the default internal units of pressure, kPa.
Default	This is the default numerical value given to the Q Variable which can be modified within the cell.

Coefficients Group

This group is only visible in the Heat of Mixing page when it is an active property.

Figure 2.41

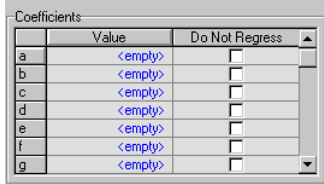

Coefficients	Value	Do Not Regress
a	<empty>	<input type="checkbox"/>
b	<empty>	<input type="checkbox"/>
c	<empty>	<input type="checkbox"/>
d	<empty>	<input type="checkbox"/>
e	<empty>	<input type="checkbox"/>
f	<empty>	<input type="checkbox"/>
g	<empty>	<input type="checkbox"/>

The Coefficients group contains the coefficient values either obtained from the HYSYS database, or regressed from data supplied in the Table tab.

Equation Form

Depending on which property you have selected, HYSYS selects a default Equation Shape. You have the option of using this equation or an alternative one. You can select a different equation from the drop-down list associated with this cell. This list contains 33 available equations to choose from.

Figure 2.42

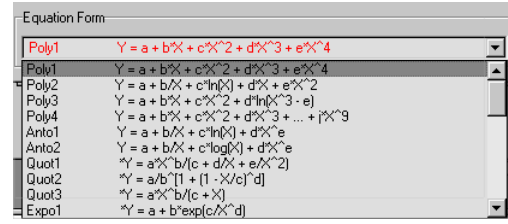

Equation Form	Equation
Poly1	$Y = a + bX + cX^2 + dX^3 + eX^4$
Poly2	$Y = a + bX + cX^2 + dX^3 + eX^4$
Poly3	$Y = a + bX + c \ln(X) + dX + eX^2$
Poly4	$Y = a + bX + cX^2 + d \ln(X^3 - e)$
Poly4	$Y = a + bX + cX^2 + dX^3 + \dots + iX^9$
Anto1	$Y = a + bX + c \ln(X) + dX^2 e$
Anto2	$Y = a + bX + c \ln(X) + dX^2 e$
Quot1	$Y = aX^2 / (c + dX + eX^2)$
Quot2	$Y = a/b [1 + (1 - X/c)^d]$
Quot3	$Y = aX^2 / (c + X)$
Expo1	$Y = a + b \exp(c/X^d)$

Some equation shapes only allow you to supply coefficients directly. You are informed if the equation shape cannot have tabular data regressed to it.

When HYSYS cannot regress the data to produce equation coefficients for the selected equation shape, the message Non-Regressible appears on the right of the drop-down list. You can still use the equation shape, but you have to manually input the coefficients.

Figure 2.43



Coeff Tab

This tab displays the current coefficients for the specified equation. Notice that this view also contains the Equation Form group, allowing you to change the equation from this tab.

Figure 2.44

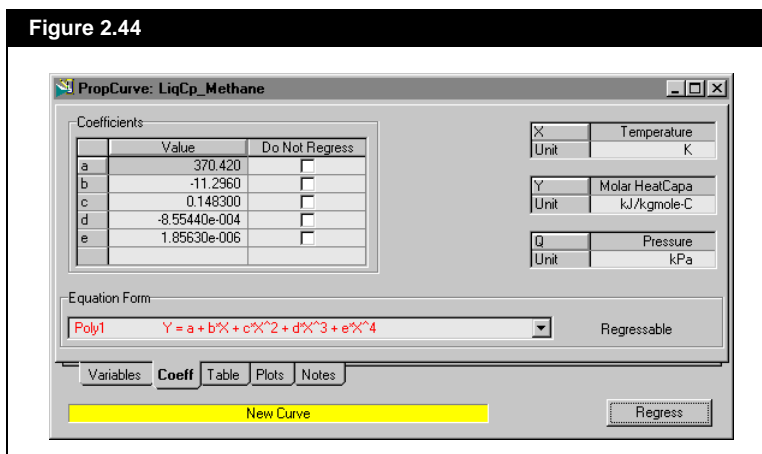

The X, Y, and Q variables and their units are displayed for reference only. They can not be modified.

The Coefficients group contains the coefficient values either obtained from the HYSYS database, or regressed from data supplied in the Table tab.

The checkboxes supplied next to each coefficient value allow you to instruct HYSYS not to regress certain coefficients, they will remain at the fixed value (default or user supplied) during regression.

Table Tab

You can supply your tabular data before or after selecting the Equation Shape. To enter data, select the Table tab.

Figure 2.45

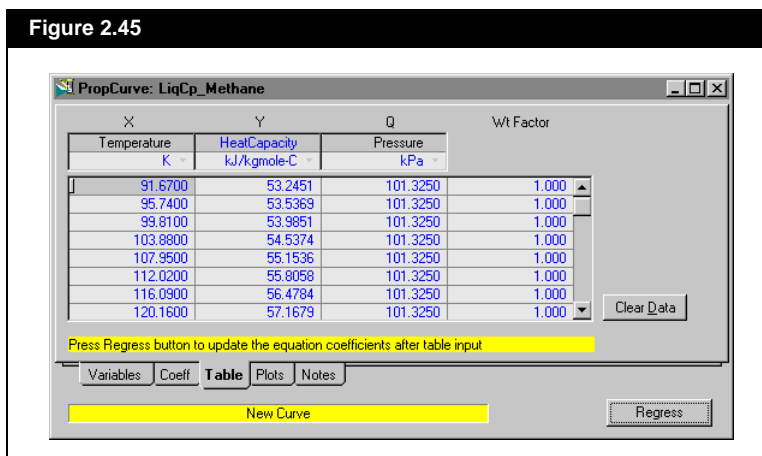

If the component is from the HYSYS library, 20 points are generated between the current Min and Max temperatures. If you need to supply data, click the Clear Data button. You can also add your data to the HYSYS default data and have it included in the regression.

Supplying Data

To delete a particular data point, highlight the data point and press the DELETE key.

If you are going to supply data, select the unit cell under the X and Y variable columns and press any key to open the drop-down list. From the list you can change to the appropriate units for your data.

The procedure for supplying data is as follows:

1. Select the appropriate units for your data.
2. Clear the existing data with the **Clear Data** button, or move to the location that you want to overwrite.
3. Supply your data.
4. Supply Net Weight Factors if desired.

Coefficients calculated using the deleted data are still present on the Coeff tab until the Regress button is clicked.

Q-Column

This column contains the Pressure variable. The presence of this extra variable helps in providing better regression for the data. As with the X and Y variables, the units for pressure can be changed to any of the units available in the drop-down list.

Wt Factor

You can apply weighting to individual data points. When the regression is performed, the points with higher weighting factors are treated preferentially, ensuring the best fit through that region.

Regressing the Data

After you have provided the data, you need to update the equation coefficients. Click the Regress button to have HYSYS regress your data, generating the coefficients based on the current shapes. If you then change any of the equation shapes, the data you supplied is regressed again. You can re-enter the regression package and select a new shape to have your data regressed.

Data Retention

Whenever experimental data is supplied, it is retained by HYSYS in memory and is stored in the case. At a later date, you can come back into the Tabular Package and modify data for the Property, and HYSYS regresses the data once again.

Plot Tab

Use the Plot button on the Tabular tab to display up to four component curves on the same graph.

To examine how the current equations and coefficients represent the property, select the Plots tab to view the plot.

Figure 2.46

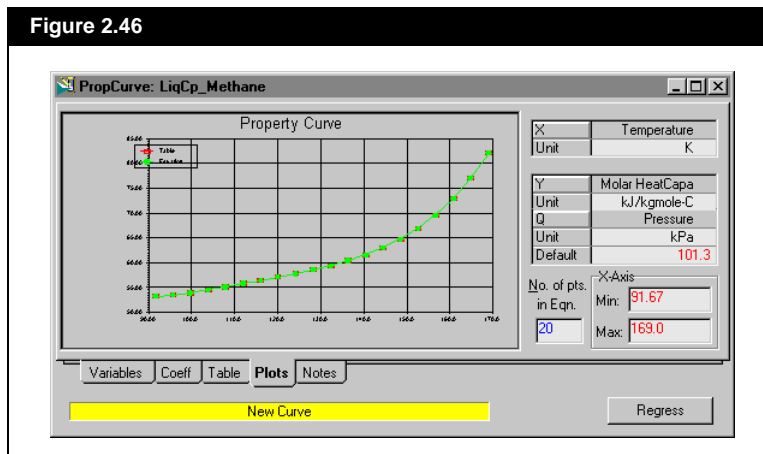

Only the selected component (in this case Methane) is displayed. The plot contains two curves, one plotted with the regressed equation and the other with the Table values. If the Tabular values supplied on the Table tab are in different units, they are still plotted here using the HYSYS internal units. This provides a means for gauging the accuracy of the regression. In this example, the two curves overlap each other, such that it appears to only show one curve.

Besides displaying the component curve, this view also displays the number of points used in determining the tabular equation (in this case 20). As well, the x-Axis group displays the Min (91.7) and Max (169) x-values on the curve.

You can change the Min and Max x-axis values and have HYSYS extend the curve appropriately. Place the cursor in the Min cell and type in a new value. For example, type 70. This replaces 91.7, and HYSYS extends the curve to include this value. Similarly, you can change the Max value, and have HYSYS extend the curve to include this new value. Type 180 to replace the Max value of 169.00.

The new curve is shown below.

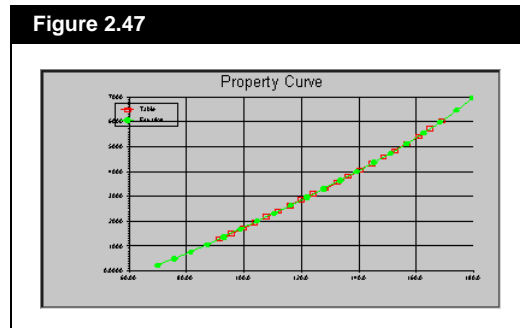

Notes Page

To review all notes within the fluid package, refer to [Section 7.20 - Notes Manager](#) of the **User Guide**.

The Notes page is used for supplying a description to associate with the Tabular Data just entered.

When you have finished providing all necessary data, close the PropCurve view and return to the Tabular tab of the Fluid Package property view. You can now continue to supply data for the other components, if you want. The properties that you have specified to be calculated with the Tabular package carry through into the Flowsheet.

2.4.8 Notes Tab

The Notes tab allows you to provide documentation that is stored with the Fluid Package. When you export a Fluid Package, any Notes associated with it are also exported. When you want to import a Fluid Package at a later date, the Notes tab allows you to view information about the Fluid Package.

2.5 COMThermo Property View

The Fluid Package COMThermo property view can be accessed by selecting the COMThermo checkbox in the Advanced Thermodynamics group. COMThermo consists of eight tabs and is based on the COMThermo thermodynamics framework. These tabs include information pertaining to the particular fluid package selected for the case. When you create a new fluid package and select the COMThermo radio button the Set Up view appears as shown below.

Figure 2.48

Select a flash calculation method here. The buttons below are used to setup the extended custom property package and extended flash.

Select the Vapor or Liquid Model Phase using the radio buttons.

Information on Property and calculation Methods depending on the Model selected. Use the drop-down list to select alternative calculation methods.

Select a property model for the vapor and liquid phase.

Additional Information on the Model selected.

Select a Component List here. It is not recommended to use the Master Component List.

Removes the Fluid Package from the case. You must confirm that you want to delete the Fluid Package.

You can input a name for the Fluid Package in this cell.

The property packages selected for the vapor and liquid phases are shown in this status bar.

Select the button to edit properties at the fluid package level.

The screenshot shows the 'Fluid Package: Basis-1' window. It features a 'Model Selection' list on the left with options like 'General NRTL', 'Grayson-Streed', and 'HysysPR'. A 'Model Phase' section has radio buttons for 'Vapor' and 'Liquid'. Below that are 'HYCONFlash' and 'HYSYSFlash multiphase' options, along with 'Extended Flash Setup...' and 'Extended PropPkg Setup...' buttons. A 'Component List Selection' dropdown shows 'Component List - 1'. The 'Advanced Thermodynamics' section has a checked 'COMThermo' checkbox and 'Regression...', 'Import', and 'Export' buttons. At the bottom, a status bar shows 'Delete', 'Name: Basis-1', 'Property Pkg: Vapor: Ideal Gas, Liquid: NRTL', and 'Edit Properties' buttons. A table titled 'Model Options' lists properties and methods, such as 'LnStdFugacity' with method 'Ideal Standard Ln Fugacity'.

Property	Method
LnStdFugacity	Ideal Standard Ln Fugacity
LnFugacityCoeff	NRTL Ln. Fugacity Coef
LnFugacity	NRTL Ln. Fugacity
LnActivityCoeff	NRTL Ln. Activity Coeff
LnActivityCoeffDT	NRTL LnActivityCoeff D
MolarDensity	CO2TALD Molar Density
MolarVolume	CO2TALD Molar Volume
ExcessEnthalpy	HMixRK1

2.5.1 Set Up Tab

The Set Up tab contains the Model Selection, Model Phase, Model Options, Extended Setup, Advanced Thermodynamics and Component List Selection groups for the Fluid Package property view in COMThermo. After a Model is selected, Properties and Method options are displayed in the Model Options group. The properties and methods that are displayed are dependent on the selected Model.

The following sections provide an overview of the various models, as well as details on the various groups that appear on the Set Up tab.

Model Selection

To create or add property packages and properties, refer to the COMThermo online help in the development kit.

In the Model Selection group, you have access to the list of default property models that are available in HYSYS-COMThermo. The availability of the models depends on the Vapour or Liquid Model Phase selected for your system. Using the radio buttons, the models are filtered for vapor and liquid models. A model for the vapor and liquid phase is required and displayed in the Property Pkg status bar.

Object	Description
Vapor Phase	The Vapor Phase contains a list of Equations of State* used to model the vapor phase in the Model Selection Group.
Liquid Phase	The Liquid Phase contains a list of the various Equations of State*, Activity Models*, and semi-empirical methods (Chao Seader & Grayson Streed) to characterize the liquid phase of a chemical system.

* Described in the following sections.

For detailed information on COMThermo Models that are available in HYSYS, refer to [Chapter 3 - Thermodynamic Calculation Models](#) in the **COMThermo Reference Guide**.

Equations of State

Equations of state are used to model the behaviour of single, two, and three phase systems. For oil, gas and petrochemical applications, the Peng Robinson Equation of State is generally the recommended property model. It rigorously solves most single phase, two phase and three-phase systems with a high degree of efficiency and reliability.

Hyprotech's enhancements to this equation of state (HysysPR), enable it to be accurate for a variety of systems over a wide range of conditions. The equation of state methods and their specific applications are described below:

EOS	Description	Available for
Ideal Gas	PV=nRT can be used to model the Vapor Phase but is only suggested for ideal systems under moderate conditions.	Vapor Phase only
PR Peng-Robinson	This model is ideal for VLE calculations as well as calculating liquid densities for hydrocarbon systems. However, in situations where highly non-ideal systems are encountered, the use of Activity models is recommended.	Vapor and Liquid Phase
HysysPR	The HysysPR EOS is similar to the PR EOS with several enhancements to the original PR equation. It extends the range of applicability and better represents the VLE of complex systems.	Vapor and Liquid Phase
PRSV Peng-Robinson Stryjek-Vera	This is a two-fold modification of the PR equation of state that extends the application of the original PR method for moderately non-ideal systems. It provides a better pure component vapor pressure prediction as well as a more flexible mixing rule than Peng robinson.	Vapor and Liquid Phase
SRK Soave-Redlich- Kwong	In many cases it provides comparable results to PR, but its range of application is significantly more limited. This method is not as reliable for non-ideal systems.	Vapor and Liquid Phase
Braun K10	This model is strictly applicable to heavy hydrocarbon systems at low pressures. The model employs the Braun convergence pressure method, where, given the normal boiling point of a component, the K-value is calculated at system temperature and 10 psia (68.95 kPa).	Vapor and Liquid Phase
KD Kabadi Danner	This model is a modification of the original SRK equation of state, enhanced to improve the vapor-liquid-liquid equilibrium calculations for water-hydrocarbon systems, particularly in dilute regions.	Vapor and Liquid Phase
Lee-Kesler- Plocker	This model is the most accurate general method for non-polar substances and mixtures.	Vapor and Liquid Phase

EOS	Description	Available for
Redlich-Kwong	The Redlich-Kwong equation generally provides results similar to Peng-Robinson. Several enhancements are made to the PR as described above which make it the preferred equation of state.	Vapor Phase only
Sour Peng-Robinson	Combines the PR equation of state and Wilson's API-Sour Model for handling sour water systems.	Vapor and Liquid Phase
Virial	This model enables you to better model vapor phase fugacities of systems displaying strong vapor phase interactions. Typically this occurs in systems containing carboxylic acids, or compounds that have the tendency to form stable hydrogen bonds in the vapor phase. In these cases, the fugacity coefficient shows large deviations from ideality, even at low or moderate pressures.	Vapor only
Zudkevitch-Joffe	This is a modification of the Redlich Kwong equation of state, which reproduces the pure component vapor pressures as predicted by the Antoine vapor pressure equation. This model is enhanced for better prediction of vapor-liquid equilibrium for hydrocarbon systems, and systems containing Hydrogen.	Vapor and Liquid Phase

See [Chapter 3 - Thermodynamic Calculation Models](#) in the **COMThermo Reference Guide** for more detailed information on the available Equations of State.

Activity Models

Although Equation of State models have proven to be reliable in predicting the properties of most hydrocarbon based fluids over a wide range of operating conditions, their application is limited to primarily non-polar or slightly polar components. Non-ideal systems at low to moderate pressure are best modeled using Activity Models. Activity models only perform calculations for the liquid phase. This requires you to specify a calculation method for the modeling of the vapor phase.

Refer to [Chapter 3 - Thermodynamic Calculation Models](#) in the **COMThermo Reference Guide** for more detailed information on the available Activity models.

The following Activity Models are available for modeling the liquid phase of a system:

Activity Model	Description
Ideal Solution	Assumes the volume change due to mixing is zero. This model is more commonly used for solutions comprised of molecules not too different in size and of the same chemical nature.
Regular Solution	This model eliminates the excess entropy when a solution is mixed at constant temperature and volume. The model is recommended for non-polar components in which the molecules do not differ greatly in size. By the attraction of intermolecular forces, the excess Gibbs energy may be determined.
NRTL	This is an extension of the Wilson equation. It uses statistical mechanics and the liquid cell theory to represent the liquid structure. It is capable of representing VLE, LLE, and VLLE phase behaviour.
General NRTL	This variation of the NRTL model uses five parameters and is more flexible than the NRTL model. The following equation format is used for the equation parameters: τ and α : $\tau_{ij} = A_{ij} + \frac{B_{ij}}{T} + \frac{C_{ij}}{T^2} + F_{ij}T + G_{ij}\ln T$ $\alpha_{ij} = \alpha 1_{ij} + \alpha 2_{ij}T$ <p>Apply this model to systems:</p> <ul style="list-style-type: none"> • with a wide boiling point range between components. • where you require simultaneous solution of VLE and LLE, and there exists a wide boiling point or concentration range between components.
UNIQUAC	Uses statistical mechanics and the quasi-chemical theory of Guggenheim to represent the liquid structure. The equation is capable of representing LLE, VLE, and VLLE with accuracy comparable to the NRTL equation, but without the need for a non-randomness factor.
Wilson	First activity coefficient equation to use the local composition model to derive the Gibbs Excess energy expression. It offers a thermodynamically consistent approach to predicting multi-component behaviour from regressed binary equilibrium data. However the Wilson model cannot be used for systems with two liquid phases.
Chien-Null	Provides consistent framework for applying existing Activity Models on a binary by binary basis. It allows you to select the best Activity Model for each pair in your case.
Margules	This was the first Gibbs excess energy representation developed. The equation does not have any theoretical basis, but is useful for quick estimates and data interpolation.
NRTL	This is an extension of the Wilson equation. It uses statistical mechanics and the liquid cell theory to represent the liquid structure. It is capable of representing VLE, LLE and VLLE phase behaviour.

Activity Model	Description
Van Laar	This equation fits many systems quite well, particularly for LLE component distributions. It can be used for systems that exhibit positive or negative deviations from Raoult's Law; however, it cannot predict maxima or minima in the activity coefficient. Therefore it generally performs poorly for systems with halogenated hydrocarbons and alcohols.
UNIFAC VLE/LLE	Both UNIFAC VLE and UNIFAC LLE use the <i>solution of atomic groups</i> model in which existing phase equilibrium data for individual atomic groups is used to predict the phase equilibria of system of groups for which there is no data. The group data is stored in specially developed interaction parameter matrices for both VLE and LLE property packages.

Vapor Pressure Models

Vapor pressure K-value models may be used for ideal mixtures at low pressures. Ideal mixtures include hydrocarbon systems and mixtures such as ketones and alcohols, where the liquid phase behaviour is approximately ideal. The models may also be used as a first approximation for non-ideal systems.

Vapor Pressure Models	Description
Antoine	This model is applicable for low pressure systems that behave ideally.
Braun K10	This model is strictly applicable to heavy hydrocarbon systems at low pressures. The model employs the Braun convergence pressure method, where, given the normal boiling point of a component, the K-value is calculated at system temperature and 10 psia (68.95 kPa).
Esso Tabular	This model is strictly applicable to hydrocarbon systems at low pressures. The model employs a modification of the Maxwell-Bonnel vapor pressure model.

Chao Seader & Grayson Streed Models

The Chao Seader and Grayson Streed methods are older, semi-empirical methods. The Grayson Streed correlation is an extension of the Chao Seader method with special emphasis on hydrogen. Only the equilibrium data produced by these correlations is used by HYSYS. The Lee-Kesler method is used for liquid and vapor enthalpies and entropies.

Model	Description
Chao Seader	Use this method for heavy hydrocarbons, where the pressure is less than 10342 kPa (1500 psia), and temperatures range between -17.78 and 260 °C (0-500 °F).
Grayson Streed	Recommended for simulating heavy hydrocarbon systems with a high hydrogen content.

Extended Property Package & Extended Flash

The Extended Property Package model allows the user to incorporate existing external property packages with minimum modifications to them. You may setup a number of different property packages using extended methods, which perform different thermodynamic calculations, handle different databases for pure compound properties and/or interaction parameters.

Unlike default COMThermo methods, which are stateless, Extended Property Packages can keep and carry state information. State information refers to data such as pure compound and mixture information. In the implementation of an Extended Property Package, the calls between different property calculation routines can be made directly without a need to use COM interfaces. You can mix and match Extended Property methods with COMThermo default property calculation methods. This can be set up in the XML model file. Refer to Extended Property Packages and Flash section in the COMThermo Programmers Guide for detailed information on how to add extended flash and extended property packages.

The COMThermo online help is located in the COMThermo DK (development kit). You need to setup the COMThermo DK from the installation disk.

To set up an Extended Property Package for calculations, you must select the same extended package for both the vapor and liquid phases.

To set up an Extended Property Package two XML model files are required, one for vapor phase and one for liquid phase. Both XML model files must contain the same package name. When selecting an extended package for calculations, the same extended package must be selected for both vapor and liquid phase.

The Extended PropPkg Setup button is accessed by selecting the appropriate extended package for both the vapor and liquid model phases. The Extended PropPkg view is shown below for an example package with ExtPkg as the name of the XML model file.

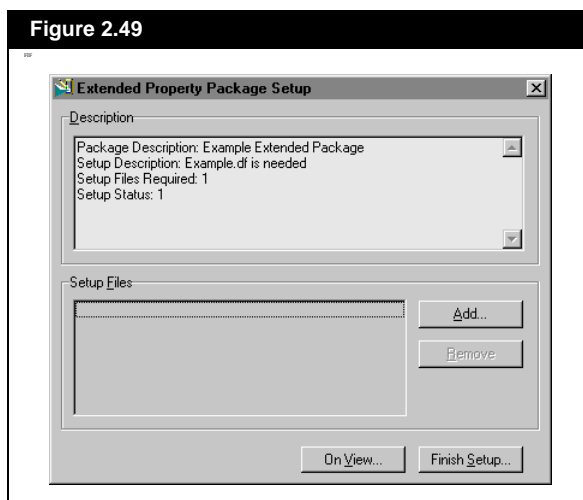

The Extended Property Package Setup includes a description of the package and the setup files. The Add button allows you to browse Setup files for the Extended Property package. The On View button allows you to see and configure the associated views of your selected extended method.

The Extended Flash model provides the user with the capability to use custom flash calculation methods. COMThermo also allows the user to mix and match different flash methods. For example, the user can implement a PV (pressure-vapor fraction) flash in an Extended Flash package and use the existing COMThermo PT flash (pressure-temperature). The flash option can be setup through the Flash Family, which is located in the Model and Flash XML section of the COMThermo online help.

A Extended Flash also requires a flash XML model file to setup the flash family name. The Extended Flash Setup button is accessed by selecting the appropriate XML model filename. The Extended Flash Setup view is shown below for an example flash with ExtendedFlash as the name of the XML model file.

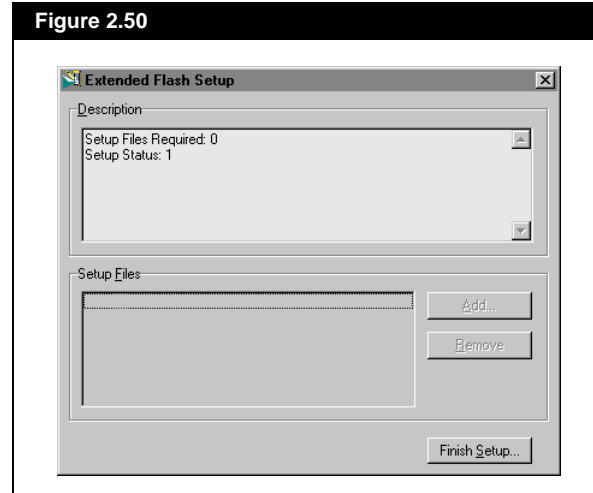

Extended Property Package and Extended Flash can be used together or separately.

Advanced Thermodynamics

The Advanced Thermodynamics group allows you to model the fluid package based on the COMThermo framework.

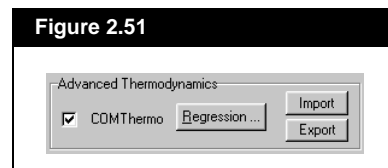

The imported/exported COMThermo Property package can be used in HYSYS, DISTIL, and COMThermo Workbench.

Refer to the Thermodynamics Workbench Manual of the Conceptual Engineering Suite for more information on COMThermo Workbench.

The Advanced Thermodynamics group contains the following buttons:

- **Import.** Allows you to import an existing COMThermo property package.
- **Export.** Allows you to export a COMThermo based property package.
- **Regression.** Allows you to export the fluid package directly into COMThermo Workbench where the fluid package can be manipulated by a broad selection of estimation methods and data regression. Once the regression is complete in the COMThermo Workbench, the regressed fluid package can be imported back to HYSYS.

You must have the Conceptual Engineering Suite installed with COMThermo Workbench licensing in order to apply the Regression feature in HYSYS.

When you click the Regression button the following view appears:

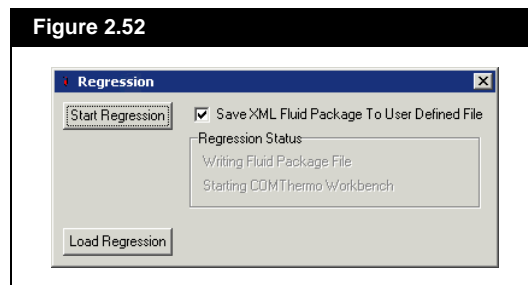

The regressed fluid package is saved with *.ctf extension along with two default tag files, **cc.XML**, and **pm.XML**. You must have all three files saved in the same directory to access the regressed fluid package.

Regression	Description
Start Regression	This button is similar to exporting a fluid package. It allows you to select a file to be opened up in COMThermo Workbench for regression analysis.
Load Regression	This button is similar to importing a fluid package. A menu of existing packages appear, allowing you to retrieve information from a previously regressed package.
Writing Fluid Package	A status indicator to indicate that a new fluid package is being generated.
Starting COMThermo Workbench	A status indicator to indicate that COMThermo Workbench is starting after the fluid package is generated.

Component List Selection

You must select a Component List to associate with the current Fluid Package from the Component List Selection drop-down list. Component Lists are stored outside of the Fluid Package Manager in the Components Manager and may contain library, hypothetical, and electrolyte components. To view the Component List View, click on the View button.

It is not recommended for users to attach the Master Component List to any Fluid Package. If only the master list exists, by default a cloned version of the Master Component List is created (called Component List -1). This list is selected initially when a new Fluid Package is created.

Model Options

When you have selected a Model, additional property and option methods are displayed on the right side of the Set Up tab in the Model Options group. This information is directly related to the Model and phase selected.

A model must be selected for both the vapor and liquid phases.

The Model options group shows each property and what calculation method is used for that property. For example, the Peng-Robinson Model Options for the vapor phase are shown below:

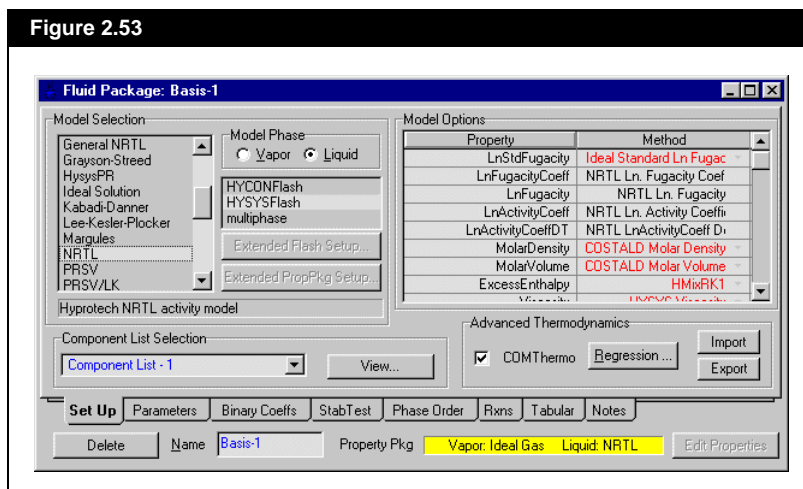

The Enthalpy property uses the Peng-Robinson Enthalpy calculation method. The method options which are displayed in red have alternative calculation methods. By placing your cursor on the drop-down list, you have a choice to select the Lee-Kesler calculation method for Enthalpy.

Figure 2.54

Property	Method
Enthalpy	Peng-Robinson Enthalpy
Entropy	Peng-Robinson Enthalpy
Cp	Lee Kesler Enthalpy
LnFugacityCoeff	Peng-Robinson Ln. Fug:
LnFugacity	Peng-Robinson Ln. Fug:
MolarVolume	Peng-Robinson Molar Vc
Viscosity	Viscosity
ThermalConductivity	Thermal Conductivity
ZFactor	Peng-Robinson Z Factor

The Entropy and Cp properties may also be altered to use the Lee-Kesler calculation methods for the Peng-Robinson EOS. If the property method is altered, it appears in blue. The information in black are default methods for HYSYS-COMThermo. Methods are added in the XML file and then can be seen in the method group for the property selected. Refer to the Wizards & Add-Ins section of the COMThermo online help located in the COMThermo Development Kit to help in adding new properties, property packages, and flash.

EOS Enthalpy, Entropy & Cp Method Specification

With most of the Equations of States, you may have two or three alternative calculation methods for enthalpy, entropy, and Cp. The property calculation methods that are available include: the EOS selected, and the Lee-Kesler method.

Methods	Description
Equation of State	With this selection, the enthalpy, entropy, and Cp calculation methods contained within the Equation of State are used.
Lee-Kesler	The Lee-Kesler method may be used for the calculation of enthalpies, entropies and Cp values. This option results in a combined Property Model, employing the appropriate equation of state for vapor-liquid equilibrium calculations and the Lee-Kesler equation for the calculation of enthalpies and entropies. This method yields comparable results to HYSYS standard equations of state and has identical ranges of applicability.

Lee-Kesler enthalpies may be slightly more accurate for heavy hydrocarbon systems, but require more computer resources because a separate model must be solved.

Once the vapor phase is selected, the liquid phase needs to be defined.

Activity Model Specifications

The Activity Models perform calculations for the liquid phase only. Once a Liquid phase model is selected, the model options group is filled with property methods. The UNIQUAC activity model options are shown below.

Figure 2.55

Property	Method
LnStdFugacity	Ideal Standard Ln Fugaci
LnFugacityCoeff	Ideal Standard Ln Fugacity w
LnFugacity	Ideal Standard Ln Fugacity w
LnActivityCoeff	UNIQUAC Ln. Activity Co
LnActivityCoeffDT	UNIQUAC LnActivityCoe
MolarDensity	COSTALD Molar Density
MolarVolume	COSTALD Molar Molume
Viscosity	HYSYS Viscosity
ThermalConductivity	HYSYS Thermal Conduc

To aid you in adding customized properties to the model options group, refer to Wizards & Add-Ins section of the COMThermo Reference Guide.

With most of the activity models, you have a choice for the calculation method for the standard Ln Fugacity Poynting Correction. By default, the ideal standard Ln Fugacity is set without the Poynting correction and may be changed using the drop-down list. The Poynting factor uses each component's molar volume (liquid phase) in the calculation of the overall compressibility factor.

2.5.2 Parameters Tab

The information and options displayed on the Parameters tab is dependent on the selection of the Property Model. Property models which require additional parameters are displayed here, while others are not. For example, the Chien-Null activity model requires parameters to specify alternative models for binary interaction parameters. The Chien-Null property package is mentioned in this section.

Chien Null

The Chien Null model provides a consistent framework for applying different activity models on a binary by binary basis. On the Parameters tab, you can specify alternative activity models to be used for each component pair.

Binary Component Parameters

To view the Chien-Null activity models table, CN must be selected as the liquid phase model and the IP Model Name on the binary coefficients tab. All components in the case, including hypotheticals are listed in the table as shown below:

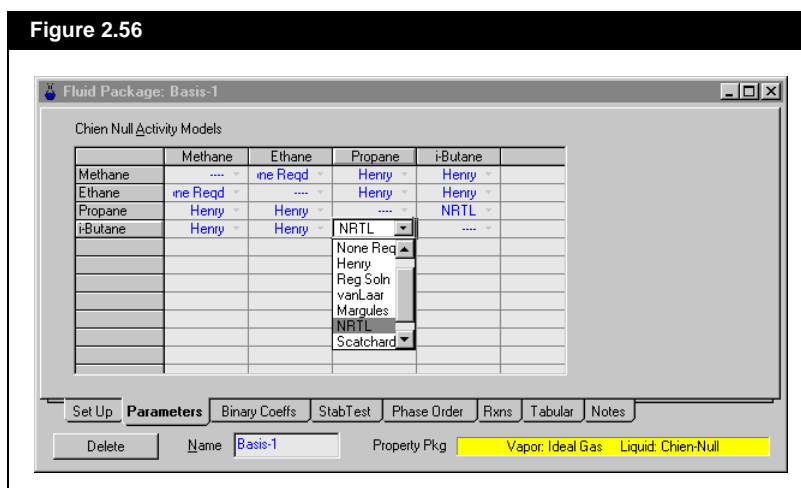

The Activity Models available in the drop-down list are:

- None Required
- Henry
- van Laar
- Margules
- NRTL
- Scatchard
- Reg Soln
- General

The table displays the default property methods provided by COMThermo for each binary pair. The methods are accessed by highlighting a cell and opening the drop-down list. From the list you can specify an Activity Model that COMThermo uses for the calculation of each binary. If Henry's Law is applicable to a component pair, COMThermo selects this as the default property method. When Henry's Law is selected by HYSYS, you cannot modify the model for the binary pair.

By default, the Henry and NRTL activity models are selected for the binary pairs in the above view. You may use the default selections, or set the property package for each binary pair. Remember that the selected method appears in both cells representing that binary.

COMThermo may filter the list of options according to the components involved in the binary pair.

2.5.3 Binary Coefficients Tab

The Binary Coefficients (Binary Coeffs) tab contains a table which lists the interaction parameters for each component pair. Depending on the property method selected, different estimation methods are available and therefore a different view may be displayed.

All known binary interaction parameters are shown and the unknown interaction parameters are displayed with dashes (---). When you exit the Basis Manager, unknown interaction parameters are set to zero. You have the option of overwriting any library interaction parameter values.

For all tables on the Binary Coeffs tab, the horizontal components across the top of the table represent the "i" component and the vertical components represent the "j" component.

Equation of State Interaction Parameter (IP)

This information applies to the following Property Models:

- Kabadi Danner
- Lee-Kesler Plocker
- PR
- PRSV
- Soave Redlich Kwong, SRK
- Sour PR
- Virial
- Zudkevitch Joffee

When you select an EOS model using the IP Model Name drop-down list, the Interaction Parameter model information is displayed on the Binary Coeffs tab as shown in the figure below.

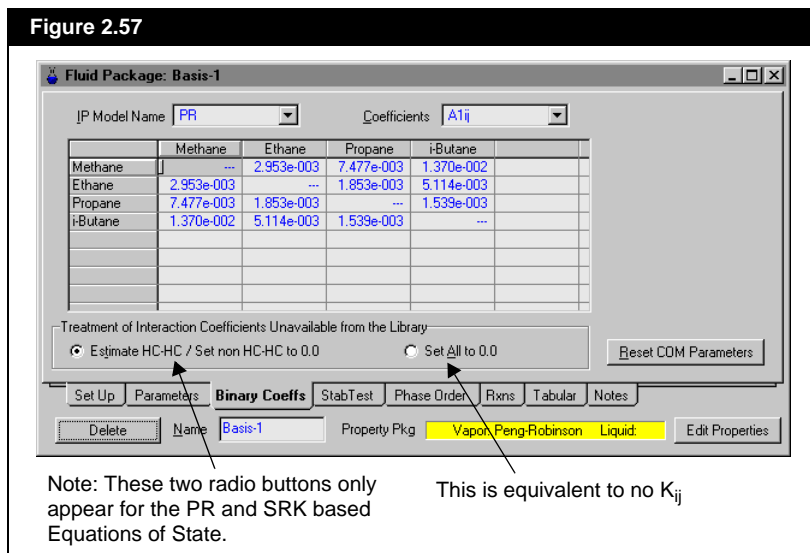

The view contains a table of cells commonly referred to as the Matrix Pane displaying binary interaction coefficients. The top of the view contains the IP Model Name and Coefficients drop-down lists. The drop-down lists determine which binary interaction coefficients are shown in the table:

Drop-Down List	Description
IP Model Name	This drop-down list shows all of the binary interaction coefficient matrices associated with the property package selected. Ordinarily there is one, two, or three binary interaction coefficient matrices per property package. Equations of state typically have one matrix, and activity coefficient models typically have two IP matrices, one for ordinary condensable components and the other for non-condensable components. The selected Model is displayed in the Matrix Pane.
Coefficients	This drop-down list shows the type of binary interaction coefficients that are displayed in the Matrix Pane. The naming convention for each binary interaction coefficient type is A_{1ij} , A_{2ij} , and so on. This resembles the "a _{ij} ", "b _{ij} " form where i and j are the column and row in the binary interaction coefficient matrix, respectively.
Reset COM Parameters	This button resets all binary interaction coefficients in the matrix pane to the original HYSYS estimated parameters.

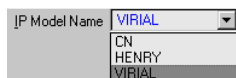

The list of options for both the Model Name and Coefficients are dependent on the property model (EOS and Activity) selected for the vapor and liquid phase. For example, if you select the Virial EOS as the vapor model, it appears in the IP Model Name drop-down list. You can view and/or edit the virial coefficients for each binary. The following IP model list represents the vapor (Virial) and liquid models (Chien-Null) chosen for the example.

Values are only shown in the matrix when the Virial Vapor Phase model is selected on the Set Up tab. You can use the default values suggested by HYSYS or edit these values. Virial coefficients for the pure species are shown along the diagonal of the matrix, while cross coefficients, which are mixture properties between components, are those not along the diagonal.

Note that Matrix Pane contains a list of the binary interaction coefficients for all binary component pairs in the Fluid Package. The naming convention is as follows:

- **i = column**
- **j = row**

The numbers that appear in the table are initially calculated by HYSYS and are modifiable. All known binary interaction parameters are displayed, with unknowns displayed as dashes (---). You have the option of overwriting any library value.

For all Equation of State parameters (except PRSV), $K_{ij} = K_{ji}$. If the value is modified for one of the parameters, both cells of the pair automatically update with the same value. In many cases, the library interaction parameters for PRSV do have $K_{ij} = K_{ji}$, but HYSYS does not force this if you modify one parameter in a binary pair.

If you are using PR, SRK or the PR Sour EOS, two radio buttons appear below the Interaction parameters table.

Radio Button	Description
Estimate HC-HC/Set Non HC-HC to 0.0	This radio button is the default selection. HYSYS provides the estimates for the interaction parameters in the table, setting all non-hydrocarbon pairs to 0.
Set All to 0.0	When this is selected, HYSYS sets all interaction parameter values in the table to 0.0.

This information applies to the following liquid property models:

- Chien Null
- General NRTL
- Margules
- NRTL
- UNIQUAC
- van Laar
- Wilson

Activity Model Interaction Parameters

The IP activity model displayed in the IP Model drop-down list is the corresponding liquid phase model selected on the Set Up tab. When you select an Activity Model in the IP Model Name list, the Interaction Parameter model information is displayed on the Binary Coeffs tab, as shown in the figure below.

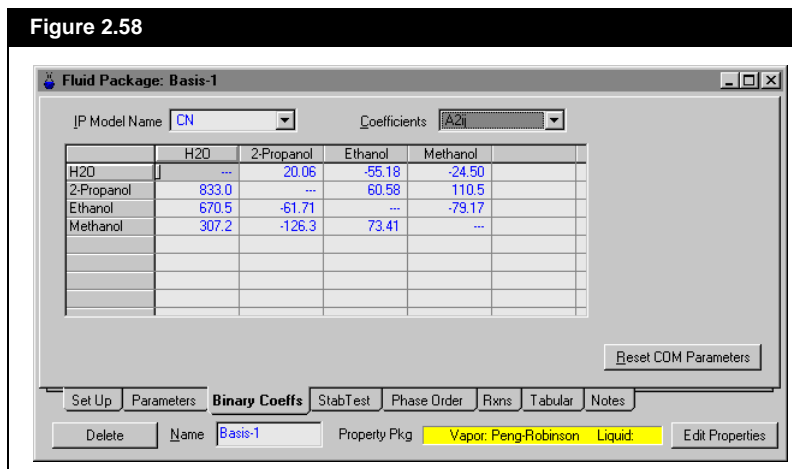

The activity models display the appropriate set of Coefficients for each component pair. For example, Chien-Null allows for 3 sets of coefficients for each component pair, where ($A1_{i,j} = a_{i,j}$, $A2_{i,j} = b_{i,j}$ and $A3_{i,j} = c_{i,j}$). Refer to the COMThermo Reference Guide for more information.

Figure 2.59

IP Model Name	Coefficients			
CN	A2i			
	H2O	2-Propanol	Ethanol	Methanol
H2O	---	20.06	-55.18	---
2-Propanol	833.0	---	60.58	110.5
Ethanol	670.5	-61.71	---	-79.17
Methanol	307.2	-126.3	73.41	---

You may reset the binary parameters to their original library values by clicking the **Reset COM Parameters** button.

The interaction parameters for each binary pair are displayed; unknown values show as dashes (---). You can overwrite any value.

To display a different coefficient matrix pane (i.e., $B_{ij} = A2_{i,j}$), select the appropriate coefficient using the drop-down list.

2.5.4 Stability Test Tab

COMThermo is not optimized for dynamics mode and may result in performance issues if used in dynamics mode.

The StabTest tab allows you to control how phase stability and flash calculations are performed. If you encounter situations where the flash fails or you are suspicious about the results, you can use this option to approach the solution using a different scheme.

For multi-phase fluids, there exist multiple false calculated solutions. A false solution exists when convergence occurs for a lower number of phases than exists in the fluid. For example, with a three-phase fluid, there is the correct three-phase solution, at least three false two-phase solutions and multiple false single-phase solutions. A major problem in converging the flash calculation is arriving at the right solution without a prior knowledge of the number of equilibrium phases.

HYSYS initially performs a two-phase flash, unless there is strong evidence for three phases. The resulting phases are then tested for their stability. The StabTest view is shown in the figure below.

Figure 2.60

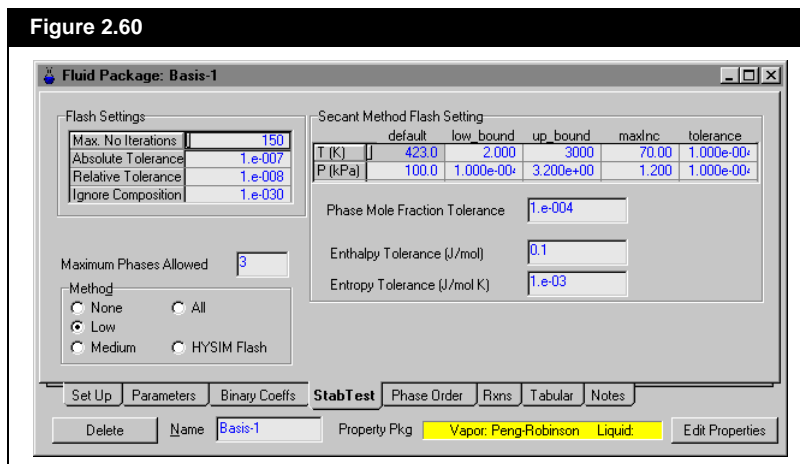

Flash Settings

Flash Settings	
Max. No Iterations	150
Absolute Tolerance	1.e-007
Relative Tolerance	1.e-008
Ignore Composition	1.e-030

The following options are available in the Flash Settings table:

Flash Settings	Description of Setting
MaximumNo. Iterations	You can set the maximum number of iterations executed in the flash calculations. The algorithm terminates after it reaches the maximum number of iterations.
Absolute Tolerance	This is the convergence tolerance of the governing flash equilibrium equations. If the equilibrium equation error is less than the Absolute Tolerance, the flash algorithm is assumed to have converged.
Relative Tolerance	In addition to the above condition, if the change in the error between iterations is less than the Relative Tolerance, the flash is assumed to have converged.
Ignore Composition	This is used to detect convergence to the trivial solution (where the compositions in the two phases are identical). If the differences in the compositions of the two phases are all less than the Trivial Composition Tolerance, the result is assumed to be trivial.

To avoid discarding azeotropic results, the compressibility (Z) factors for the two phases are computed and compared in the case where the two phases involved are modeled using the same Property Methods (Equation of State Methods).

Stability Test Parameters

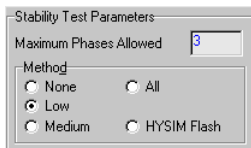

The Stability Test Parameters group is described in the following sections.

Maximum Phases Allowed

You can specify the maximum number of phases allowed. If the maximum is set to 2, the stability test terminates after a 2-phase flash. Occasionally, you may still get three phases, as the algorithm may attempt to start directly with the 3-phase flash.

Note that if the true solution has two phases and the maximum phases allowed is set to two, there is still no guarantee that the correct solution is reached. For instance, for binary mixtures around the azeotropic point, the correct solution may be liquid-liquid equilibrium, but the algorithm may incorrectly converge to vapor-liquid equilibrium.

The Stability scheme used is proposed by Michelson(1980a). In the Method group, you can choose the method for performing the stability test calculations by selecting one of the radio buttons:

Method Radio Button	Description
None	No stability test is performed.
Low	Uses a default set of Phases/Components to Initiate the Stability Test. The following methods are used: Deleted Phase, Wilson's Equation and Component Initiation (Water). Only the water component (if it is part of your Fluid Package) is "introduced".
Medium	In addition to those methods used for the Low method, the Average of Existing and Ideal Gas methods are also included. As well, the heaviest and the lightest components in the fluid are "introduced" using the Component Initiation method.
All	All Phase Initiation methods are utilized, and all components are introduced using the Component Initiation method.

Secant Method Flash Setting

The Secant Method Flash Setting group is shown below.

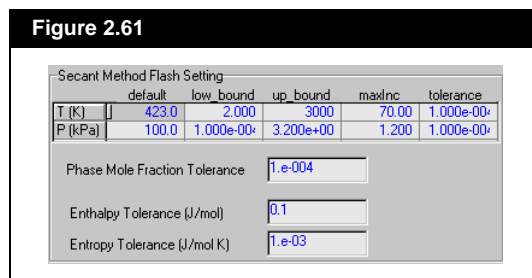

The settings that are available for the Secant Method Flash are shown in the following table.

Temperature & Pressure Settings	Description
Default	The default or initial value.
low_bound	The lower or minimum bound for the secant method search.
up_bound	The upper or maximum bound for the secant method search.
maxInc	The maximum increment or initial step size for the secant temperature search. The logarithm of pressure is used as the primary variable for the pressure search, thus an initial pressure multiplier is used as the pressure increment.
tolerance	The tolerance during the secant temperature and pressure search. It is used mainly by the backup flashes.

Phase Mole Fraction Tolerance

The phase fraction tolerance is used whenever a vapor fraction is given along with a temperature or pressure for the secant method flash. HYSYS guesses a temperature or pressure depending on which variable is required and predicts a new vapor fraction. The calculation terminates when the vapor fraction is within the tolerance range and the flash is converged.

Enthalpy Tolerance

Different combinations may be used to flash. If the enthalpy is given, HYSYS guesses a temperature or pressure depending on which one is required and predicts a new enthalpy until the flash is converged within the tolerance specified.

Entropy Tolerance

Different combinations may be used to flash. If the entropy is given, HYSYS guesses a temperature or pressure depending on which one is required and predicts a new entropy until the flash is converged within the tolerance specified.

2.5.5 Reactions Tab

The COMThermo Rxns tab is the same as the traditional HYSYS property view. See [Section 2.4.6 - Reactions Tab](#).

2.5.6 Notes Tab

See traditional HYSYS thermodynamics [Section 2.4.8 - Notes Tab](#).

2.6 References

- ¹ Wong, D. S. H., Sandler, S. I., "A Theoretically Correct Mixing Rule for Cubic Equations of State", *A.I.Ch.E. Journal*, 38, No. 5, p.671 (1992)

3 Hypotheticals

3.1 Introduction	3
3.2 Hypo Manager	4
3.3 Adding a Hypothetical - Example	5
3.3.1 Creating the Ethanol Hypo	5
3.3.2 Hypo/Library Component Comparison	10
3.4 Creating a Hypo Group	11
3.4.1 Hypo Group View	12
3.4.2 Supplying Basic Information	15
3.4.3 UNIFAC Structure.....	20
3.5 Hypothetical Component Property View	23
3.5.1 ID Tab	25
3.5.2 Critical Tab.....	25
3.5.3 Point Tab	26
3.5.4 TDep Tab.....	29
3.6 Solid Hypotheticals	32
3.6.1 ID Tab	32
3.6.2 Props Tab	33
3.6.3 Point Tab	34
3.6.4 TDep Tab.....	35
3.6.5 PSD Tab	36
3.7 Cloning Library Components	37
3.7.1 Converting a Library Component to a Hypo	38

3.8 Hypo Controls	39
3.8.1 Viewing Groups	39
3.8.2 Moving Hypos.....	40
3.9 References	40



3.1 Introduction

HYSYS allows you to create non-library or Hypothetical components from the Hypo Manager. Hypothetical components can be pure components, defined mixtures, undefined mixtures, or solids. You can also convert/clone HYSYS library components into Hypotheticals, which allow you to modify the library values.

The Hypo Manager is located on the Hypotheticals tab of the Simulation Basis Manager. It can also be accessed via the Hypo manager button from the Components tab under hypothetical components.

A wide selection of estimation methods are provided for the various Hypo groups (hydrocarbons, alcohols, etc.) to ensure the best representation of behaviour for the Hypothetical component in the simulation. In addition, methods are provided for estimating the interaction binaries between hypotheticals and library components. You can also use Hypotheticals with the Tabular Package, as well as in Reactions.

In HYSYS, Hypothetical components exist independent of the Fluid Package. When a Hypothetical is created, it is placed in a Hypo Group. From the Hypo Manager, you can create new Hypo Groups and move Hypothetical components within the Hypo Groups. Hypo Groups can also be imported and exported, thus making them available to any simulation case.

Since Hypothetical components are not exclusively associated with a particular Fluid Package, it is possible for multiple Fluid Packages to share Hypotheticals. In other words, you only need to create a Hypothetical once, and it can be used in any Fluid Package throughout the case.

3.2 Hypo Manager

By selecting the Hypotheticals tab from the Simulation Basis Manager, the following view appears:

Figure 3.1

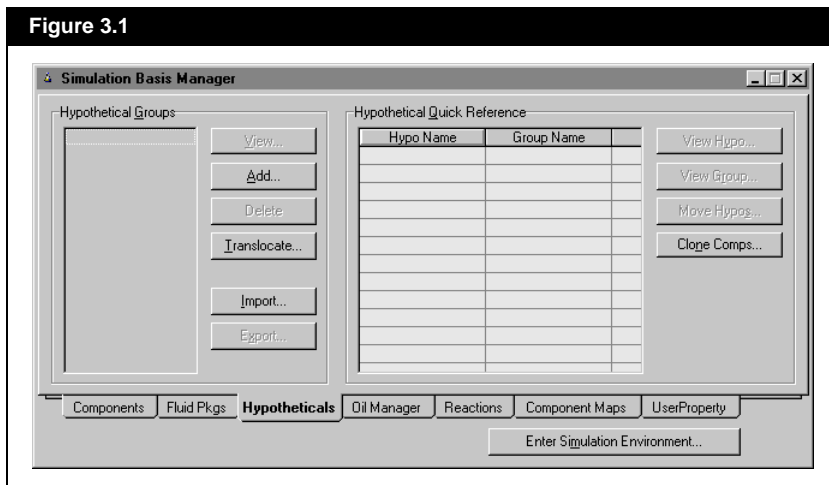

Note that you can Import and Export Hypothetical groups, allowing you to use defined hypotheticals in any future simulation.

Hypothetical groups and individual hypothetical components can be installed in more than one Fluid Package.

The left side of the view is the Hypothetical Groups group. This lists all the Hypothetical groups currently installed in the simulation. The available commands for this group (accessed using the associated buttons) are as follows:

Button	Description
View	Accesses the Hypo Group view for the selected group.
Add	Adds a Hypothetical Group to the present case.
Delete	Deletes the selected Hypothetical Group from the case.
Translocate	Searches through all of the hypothetical components in the case and if there are duplicates HYSYS replaces them and puts all the duplicates in a separate Hypo group which then can be deleted. This is intended for use when large cases have had large numbers of templates/fluid packages imported and there are lots of repeated hypotheticals in the case.
Import	Imports a Hypothetical Group from disk.
Export	Exports the selected Hypothetical Group and saves it to a file, so that it can be retrieved at a later time.

The right side of the view displays the Hypothetical Quick Reference group. This group includes all Hypotheticals currently installed in the Basis Environment (Hypo Name column) along with their associated Hypo Groups (Group Name column). The available buttons within this group are described below:

Button	Description
View Hypo	Access the property view for the highlighted Hypothetical.
View Group	Access the Hypo Group view for the highlighted Hypothetical.
Move Hypos	Move Hypotheticals from one Hypo Group to another.
Clone Comps	Use a copy of a selected library components as the basis for defining a Hypothetical.

3.3 Adding a Hypothetical - Example

In this example, a hypothetical Ethanol component is defined, and the results to the library Ethanol component using the Wilson property package are compared. The ethanol hypothetical component is defined as having a boiling point of 78.25 °C and a specific gravity of 0.789.

3.3.1 Creating the Ethanol Hypo

To create a ethanol hypo, follow the steps outlined below:

1. Open a new case in HYSYS and select the **Hypotheticals** tab of the Simulation Basis Manager.
2. From the Hypothetical Groups group, click the **Add** button to create a new Hypothetical Group. HYSYS automatically names this group **HypoGroup1**. You can change the name later, if desired.

You must install a Hypothetical Group before you can install a Hypo component.

From the Session Preferences view, select SI as the units for the case.

- When you add a new Hypothetical Group, HYSYS automatically opens the Hypo Group view, where you add and define the Hypothetical component(s) for the group. On this view, enter **HypoAlcohol** as the new Group Name.

Figure 3.2

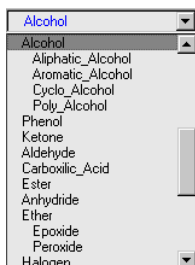
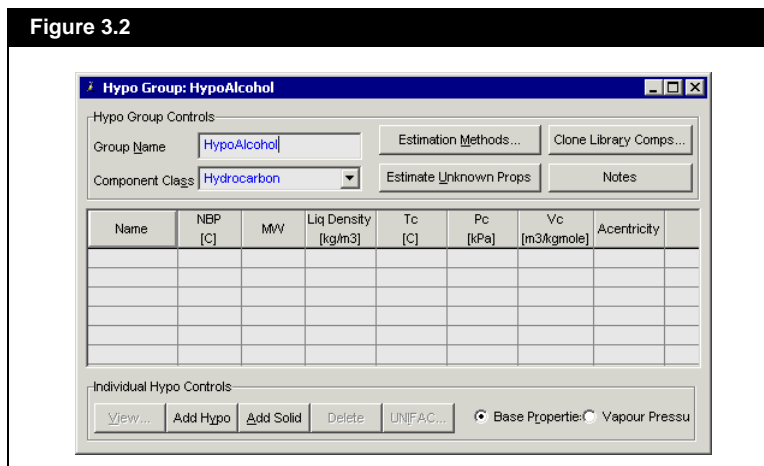

- Notice that the HYSYS default in the **Component Class** list is Hydrocarbon. For this example, select **Alcohol** for the Component Class using the drop-down list.
- Now, install a Hypothetical component. From the **Individual Hypo Controls** group, click the **Add Hypo** button. This adds a Hypothetical component and automatically names it **Hypo20000***.
- Enter a new name for this component by selecting the **Name** cell typing **HypoEtoh**.
- In the **NBP** cell, enter the normal boiling point of the component as **78.25°C**.
- The specific gravity for the hypothetical component is 0.789. In the **Liq Density** cell, enter **0.789** and select the **SG_H2O60api** units. A liquid density of 787.41 kg/m^3 is calculated by HYSYS.

Figure 3.3

Name	NBP [C]	MW	Liq Density [kg/m3]	Tc [C]	Pc [kPa]	Vc [m3/kgmole]	Acentricity
HypoEtoh*	78.25	<empty>	787.41	<empty>	<empty>	<empty>	<empty>

9. Although HYSYS could estimate the unknown properties for HypoEtoh with only the NBP and Liquid Density, more accurate results are obtained if the component structure is supplied. Click the **UNIFAC** button to access the **UNIFAC Component Builder**.

Figure 3.4

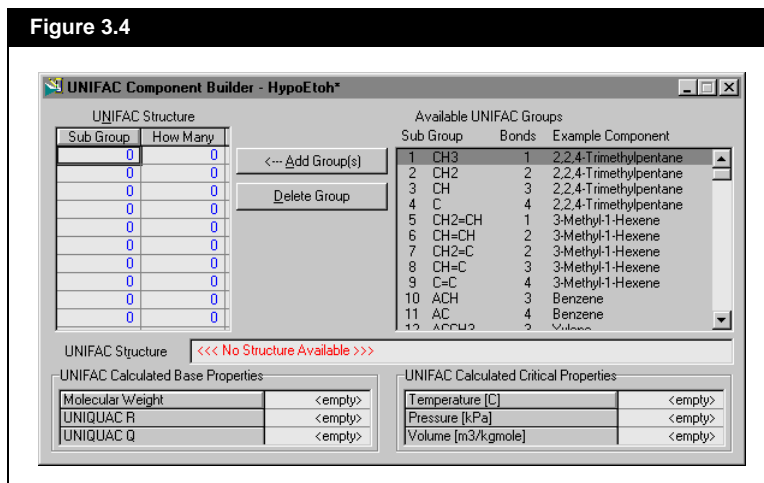

10. The chemical formula of ethanol is C_2H_5OH , and it is comprised of the groups CH_3 , CH_2 , and OH . Highlight CH_3 in the **Available UNIFAC Groups** list. It is the first selection in the list.
11. Click the **Add Group(s)** button. Notice that a “1” is displayed under Sub Group in the **UNIFAC Structure** group. By default, HYSYS assigns the value “1” to the **How Many** cell. The number is valid, since this is the number of CH_3 groups required. The number of Free Bonds has increased to 1 with the addition of the CH_3 Sub Group.
12. To add the CH_2 group, highlight it in the **Available UNIFAC Groups** list (it is the second in the list) and click the **Add Group(s)** button. Again, only 1 Sub Group is required, so the default is acceptable.

13. Since the OH group is not immediately visible in the list of **Available UNIFAC Groups**, a different approach is taken. In the **UNIFAC Structure** input field, type OH at the end of the existing structure (CH3CH2) and press ENTER.

Figure 3.5

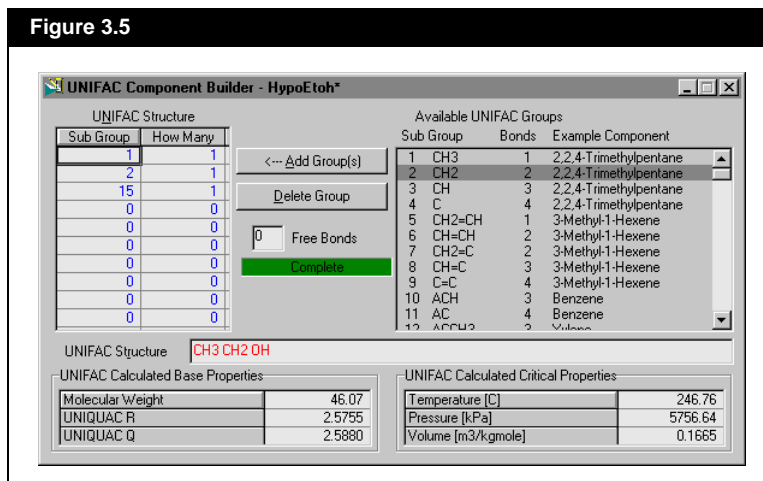

Notice that the Incomplete status message is replaced with Complete when there are 0 Free Bonds.

14. Once the UNIFAC Structure is complete, HYSYS calculates the UNIFAC Base and Critical Properties. Click the **Close** icon to close the view and return to the Hypo Group view.
15. HYSYS can now use the existing information (NBP, Liquid Density and UNIFAC structure) to estimate the remaining properties for the Hypothetical component. First, the Estimation Method that HYSYS uses is examined. Click the **Estimation Methods** button to access the Property Estimation view.

Property Estimation Methods are explained in [Section 3.4.2 - Supplying Basic Information](#).

Figure 3.6

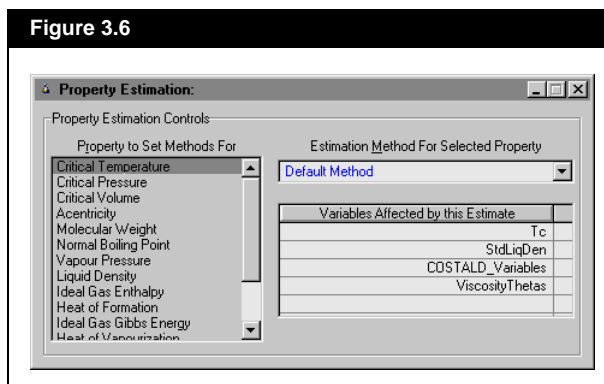

16. If you want, you can change the estimation method for any property. In this example, all properties use the Default Method. Click the **Close** icon to return to the Hypo Group view.
17. Click the **Estimate Unknown Props** button and HYSYS uses the currently specified methods to estimate the unknown properties for the component. The molecular weight for the hypothetical is the same as the molecular weight for ethanol, 46.07, since the UNIFAC structure is used for the Hypo component.

Remember that specified values are displayed in blue, and HYSYS estimated values are displayed in red.

Figure 3.7

Name	NBP [C]	M/W	Liq Density [kg/m3]	Tc [C]	Pc [kPa]	Vc [m3/kgmole]	Acentricity
HypoEtOH*	78.25	46.07	787.41	246.76	5756.64	0.1665	0.5677

18. You can examine all properties for the Hypo through its property view. Double-click on the Hypothetical component name, **HypoEtOH**, to access the Component property view.

Figure 3.8

Component Identification

Component Name	HypoEtOH*
Family / Class	Alcohol
Chem Formula	
ID Number	20000
Group Name	HypoAlcohol
CAS Number	

UNIFAC Structure

Structure Builder...

CH3 CH2 OH

User ID Tags

Tag Number	Tag Text
1	<empty> Not Spec'd

ID Critical Point TDep UserProp

Estimate Unknown Props Edit Properties Edit Visc Curve

For further information regarding the Property View, refer to [Section 3.5 - Hypothetical Component Property View](#).

19. Click the **Close** icon to return to the Hypo Group view.
20. Click the **Close** icon and HYSYS returns you to the Hypotheticals tab of the Simulation Basis Manager. The Ethanol Hypothetical has been created.

3.3.2 Hypo/Library Component Comparison

To conclude, compare the ethanol hypothetical to the ethanol library component. Go to the Simulation Basis Manager:

1. On the **Fluid Pkgs** tab, click the **Add** button to install the new Fluid Package.
2. On the **Set Up** tab, select **Wilson** as the Property Package and close the fluid package view.
3. Move to the **Components** tab and add **Ethanol** to the Selected Component List by highlighting the Components page in the Add Component group.
4. From the Available Hypo Components group, highlight the **HypoEtoh*** component and click the **Add Hypo** button from the Hypothetical page.
5. Move to the **Binary Coeffs** tab in the fluid package property view and click the **Unknowns Only** button in the Coeff Estimation group.
6. Close the Fluid Package property view.
7. Click the **Enter Simulation Environment** button to enter the Main Environment.
8. In the Workbook, create the stream **Pure**. Enter a vapour fraction of **0** and a pressure of **1 atm** for the stream on the Material Streams tab of the workbook. Move to the Compositions tab and enter **1** for the mole fraction of Ethanol, and **0** for HypoEtoh*.
9. Now create a second stream, **Hypo**. Enter a vapour fraction of **0** and a pressure of **1 atm** for the stream. The mole fraction of **HypoEtoh*** is **1**, and that for Ethanol is **0**.

When you have specified these two streams, HYSYS calculates the bubble point temperature for each stream. The Conditions tab of the property view for each stream is shown below.

Figure 3.9

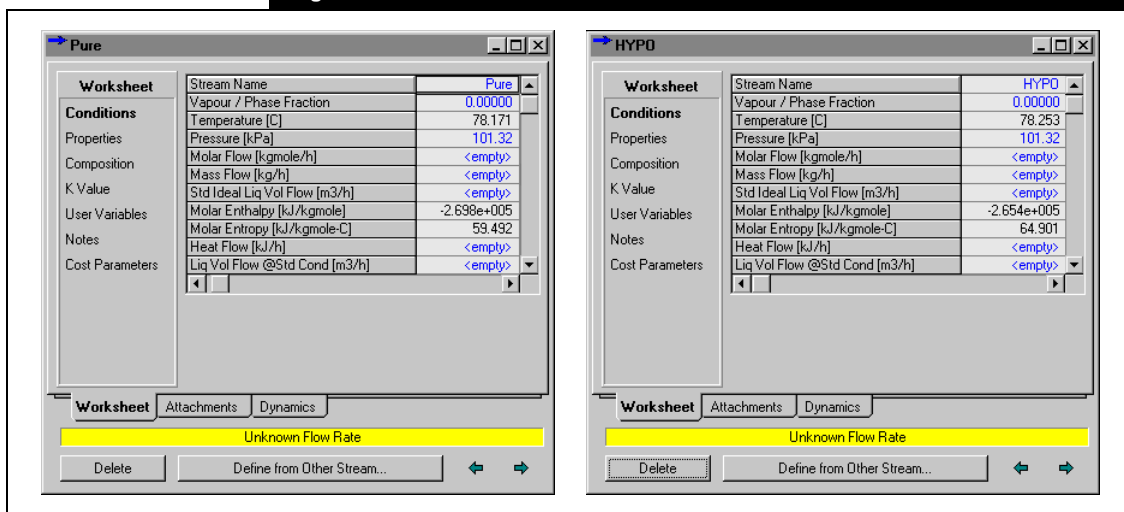

3.4 Creating a Hypo Group

When defining a hypothetical, there is no set procedure. The following is a suggested sequence in which you can follow:

1. Create the Hypo Group. For more information, see [Section 3.4.1 - Hypo Group View](#).
2. Select the Component Class for the Hypo Group. For more information, see [Section 3.4.1 - Hypo Group View](#).
3. Set the Estimation Methods for the Group (optional). For more information, see [Section 3.4.2 - Supplying Basic Information](#).
4. Install the Hypotheticals.
5. Supply all information that you have for the Hypo. For more information, see [Section 3.4.2 - Supplying Basic Information](#).
6. Supply a UNIFAC structure for the Hypo (optional). For more information, see [Section 3.4.3 - UNIFAC Structure](#).
7. Estimate the Properties for the Hypo.

3.4.1 Hypo Group View

As mentioned in the Hypothetical example, you add a Hypo Group by clicking the Add button from the Hypotheticals tab of the Simulation Basis Manager. This opens the Hypo Group view, which contains two groups, (Hypo Group Controls and Individual Hypo Controls), and a table of estimated or known property values.

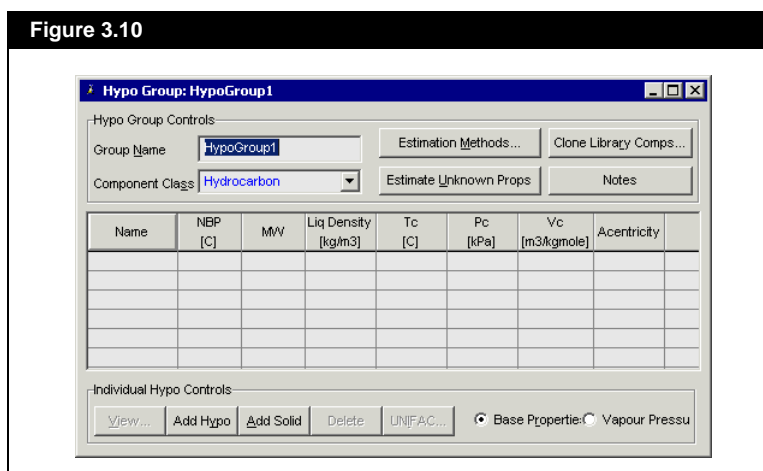

Hypo Group Controls

Note that for the Component Class, there are varying levels of specificity. For example, under Alcohol, you can specify sub-classes of alcohols, such as Aliphatic, Aromatic, Cyclo and Poly. Using a stricter degree of component type assists HYSYS in choosing appropriate estimation methods; however, it forces all components to be calculated using the same method. If you want to mix component classes (i.e., both Aliphatic and Aromatic inside the same Hypo Group), select the more general Component Class of Alcohol.

The Hypo group contains the following options:

Option	Description
Group Name	Displays the current name for the Hypothetical Group. HYSYS provides a default name, but you can change this to a more descriptive name. Individual Hypothetical components must reside inside of a Hypothetical group.
Component Class	Every component in a Hypo Group must be of a common Component Class. The options are accessed using the drop-down list attached to the input cell. There is a wide selection of available Classes, which allows for better estimation of the component properties. HYSYS, by default, selects the Component Class to be Hydrocarbon. Prior to installing any components, select the Component Class.
Estimation Methods	Accesses the Property Estimation view, from which you can select an estimation method for each property. The selected estimation methods apply to all Hypotheticals in the Hypo Group.

Option	Description
Estimate Unknown Props	This button estimates the unknown properties for all Hypothetical components within the Hypo Group, using the methods chosen on the Property Estimation view. For more information, see Section 3.4.2 - Supplying Basic Information .
Clone Library Comps	HYSYS allows you to convert library components into hypothetical components. For more information, see Section 3.7 - Cloning Library Components .
Notes	Allows you to supply Notes and Descriptions for the Hypothetical Group. This is useful when exporting Hypo groups, because when you import them later, the description appears along with the Hypo group name.

Individual Hypo Controls

The Individual Hypo Controls group at the bottom of the Hypo Group view contains buttons for manipulating the Hypotheticals within the Hypo Group and two radio buttons for switching between Base Properties and Vapour Pressure data.

Button	Description
View	Displays the Property View for the highlighted hypothetical component.
Add Hypo	Automatically adds a new hypothetical component to the group. HYSYS places the new Hypo in the table, and names it according to the default naming convention (set in the Session Preferences).
Add Solid	Automatically adds a new solid hypothetical component to the group. HYSYS places the new Hypo in the table, and names it according to the default naming convention (set in the Session Preferences).
Delete	Deletes the highlighted hypothetical component from the case. After deleting a Hypo it cannot be recovered.
UNIFAC	Opens the UNIFAC Component Builder, from which you can provide the UNIFAC Structure for the highlighted hypothetical component.

The View, Delete, and UNIFAC buttons will not be available unless a hypothetical is present in the case.

The table displayed in the middle section of the Hypo Group view, displays either the Base Properties or the Vapour Pressure properties, depending on which radio button is selected. You can add a new Hypo component in either the Base Properties or Vapour Pressure view.

Base Properties

These properties are the same as those shown on the **Critical** tab of the Hypo component property view.

The Base Properties for each Hypothetical are shown on the Hypo Group view when the Base Properties radio button is selected.

Figure 3.11

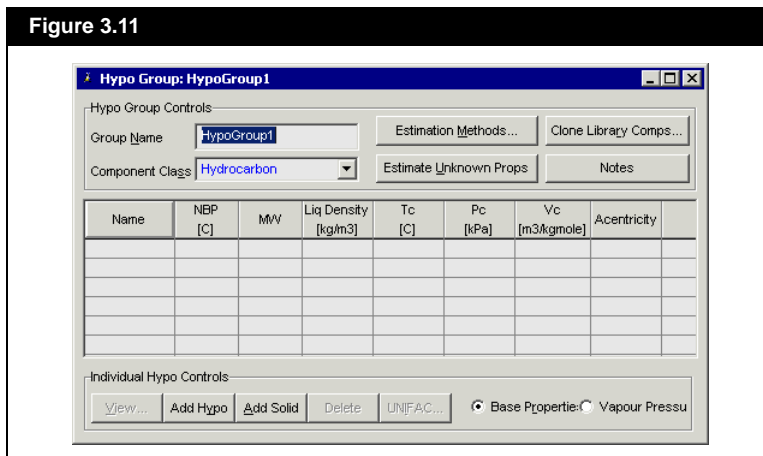

Individual Base Properties are supplied by selecting the appropriate cell. Use the drop-down list to select the units within the cell.

The table lists each Hypothetical along with the following Base Properties:

Base Property	Description
NBP	Normal boiling point
MW	Molecular weight
Liq Density	Liquid density
Tc	Critical temperature
Pc	Critical pressure
Vc	Critical volume
Acentricity	Acentric factor

Vapour Pressure Properties

The values shown on this view are also available on the TDep tab of the individual Hypo property view.

Use the horizontal scroll bar to view Coeff E and Coeff F.

The Vapour Pressure table displays the temperature range and Antoine Coefficients for the hypothetical components. Also shown are the pressure and temperature units on which the equation is based and the form of the equation.

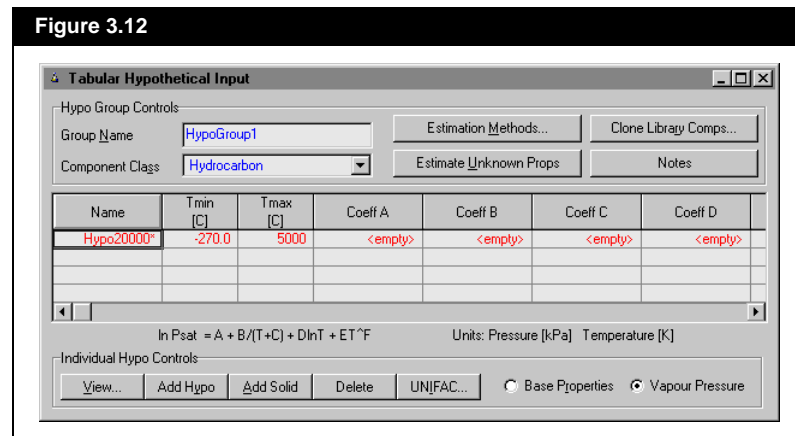

3.4.2 Supplying Basic Information

Before HYSYS can estimate the properties for a hypothetical, some information about the Hypo must be provided. For the estimation, you must supply a minimum amount of information and select the estimation methods to be used.

Minimum Information Required

The more information you can supply, the more accurate the estimations are.

If the hypothetical component is defined as a hydrocarbon, the appropriate default correlations can be used to calculate its critical properties or any other missing information. Its interaction parameters are also calculated by HYSYS based on the estimated critical properties. For HYSYS to estimate the component's critical properties, a minimum amount of information must be supplied, as shown in the following table.

Normal Boiling Point	Minimum Required Information
< 700 °F (370 °C)	Boiling Point
> 700 °F (370 °C)	Boiling Point and Liquid Density
Unknown	API & Molecular Weight

Estimation Methods

Prior to installing any Hypotheticals into a Hypo group, examine the Estimation Methods which HYSYS uses to calculate the unknown properties for a hypothetical component. You can specify a estimation method for each property. Click the Estimation Methods button on the Hypo Group view.

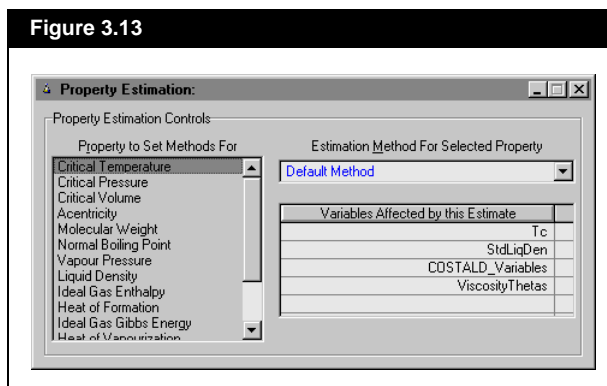

The Estimation Methods that you choose for the Hypo Group apply to all Hypotheticals in that group.

There are three groups in the Property Estimation view and are described below:

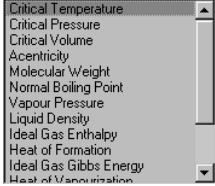
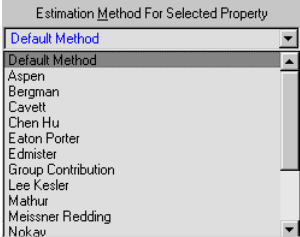
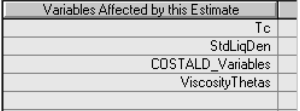
Group	Description	View
Property to Set Methods For	This group lists all the available properties. From the list, choose the property for which you want to set the Estimation Method. Use the scroll bar to move through the list. Initially, HYSYS sets all the properties to the Default Method.	
Estimation Method For Selected Property	This drop-down list displays all the available estimation methods for the highlighted property. Depending on the property, the drop-down list differs. The list shown here is a partial display of estimation methods for Critical Temperature.	
Variables Affected by this Estimate	This group lists all the variables that are affected by the selected estimation method. The list changes depending on the property selected. For example, when you select an estimation method for Critical Temperature, you are not only affecting the critical temperature, but also the properties which use critical temperature in their estimation or calculation.	

The following table individually lists each Property, its Default Method, its Available Estimation Methods and the Variables Affected by estimating the Property. It is understood that each property can have Do Not Estimate selected as its Estimation Method, so this option does not appear in the Available Methods list.

Property	Default Method	Available Methods	Variables Affected
Critical Temperature	<ul style="list-style-type: none"> if $\rho_{LIQ} > 1067 \text{ kg/m}^3$ or NBP $> 800 \text{ K}$, Lee-Kesler is used if NBP $< 548.16 \text{ K}$ and $\rho_{LIQ} < 850 \text{ kg/m}^3$, Bergman is used all other cases, Cavett is used 	Aspen, Bergman, Cavett, Chen Hu, Eaton Porter, Edmister, Group Contribution, Lee Kesler, Mathur, Meissner Redding, Nokay, Riazi Dauber, Roess, PennState, Standing, Twu	<ul style="list-style-type: none"> Critical Temperature Standard Liquid Density COSTALD Variables Viscosity Thetas
Critical Pressure	<ul style="list-style-type: none"> if $\rho_{LIQ} > 1067 \text{ kg/m}^3$ or NBP $> 800 \text{ K}$, Lee-Kesler is used if NBP $< 548.16 \text{ K}$ and $\rho_{LIQ} < 850 \text{ kg/m}^3$, Bergman is used all other cases, Cavett is used 	Aspen, Bergman, Cavett, Edmister, Group Contribution, Lee Kesler, Lydersen, Mathur, PennState, Riazi Daubert, Rowe, Standing, Twu	<ul style="list-style-type: none"> Critical Pressure Standard Liquid Density COSTALD Variables Viscosity Thetas
Critical Volume	<ul style="list-style-type: none"> Pitzer 	Group Contribution, Pitzer, Twu	<ul style="list-style-type: none"> Critical Volume Standard Liquid Density COSTALD Variables Viscosity Thetas
Acentricity	<ul style="list-style-type: none"> for Hydrocarbon, Lee-Kesler is used all other cases, Pitzer is used 	Bergman, Edmister, Lee Kesler, Pitzer, Pitzer Curl, Robinson Peng	<ul style="list-style-type: none"> w ω_{Gs} Standard Liquid Density COSTALD Variables Viscosity Thetas
Molecular Weight	<ul style="list-style-type: none"> if NBP $< 155 \text{ }^\circ\text{F}$, Bergman is used all other cases, Lee-Kesler is used 	API, Aspen, Aspen Leastq, Bergman, Hariu Sage, Katz Firoozabadi, Katz Nokay, Lee Kesler, PennState, Riazi Daubert, Robinson Peng, Twu, Whitson	<ul style="list-style-type: none"> Molecular Weight
Normal Boiling Point	<ul style="list-style-type: none"> Hyprotech proprietary method 	Twu	<ul style="list-style-type: none"> Normal Boiling Point Viscosity Thetas
Vapour Pressure	<ul style="list-style-type: none"> for Hydrocarbon, Lee-Kesler is used all other cases, Riedel is used 	Gomez Thodos, Lee Kesler	<ul style="list-style-type: none"> Antoine Coefficient PRSV_kappa
Liquid Density	<ul style="list-style-type: none"> Yen-Woods 	Bergman, BergmanPNA, Chueh Prausnitz, Gunn Yamada, Hariu Sage, Katz Firuzabadi, Lee Kesler, Twu, Whitson, Yarborough, Yen Woods	<ul style="list-style-type: none"> Standard liquid Density COSTALD Variables

Property	Default Method	Available Methods	Variables Affected
Ideal Gas Enthalpy	<ul style="list-style-type: none"> Cavett 	Cavett, Falon Watson, Group Contribution, Lee Kesler, Modified Lee Kesler,	<ul style="list-style-type: none"> Ideal H Coefficient
Heat of Formation	<ul style="list-style-type: none"> for chemical structure defined in UNIFAC groups, Joback is used all other cases, this formula is used: $\frac{H_{form}(octane) \cdot MW}{MW(octane)}$ 	Group Contribution	<ul style="list-style-type: none"> Heat of Formation Heat of Combustion
Ideal Gas Gibbs Energy	<ul style="list-style-type: none"> Hyprotech proprietary method 	Group Contribution	<ul style="list-style-type: none"> Gibbs Coefficient
Heat of Vapourization	<ul style="list-style-type: none"> Two Reference Fluid (using benzene and carbazole) 	Chen, Pitzer, Riedel, Two Reference ¹ , Vetere	<ul style="list-style-type: none"> Cavett Variables
Liquid Viscosity	<ul style="list-style-type: none"> for non-Hydorcarbon or NBP < 270 K Letsou Stiel is used for Hydorcarbon and NBP < 335 K, NBS viscosity is used all other cases, Twu is used 	Hyprotech Proprietary, Letsou Stiel	<ul style="list-style-type: none"> Viscosity Thetas
Surface Tension	<ul style="list-style-type: none"> Brock Bird 	Brock Bird, Gray, Hankin, Sprow Prausnitz	<ul style="list-style-type: none"> Tabular Variables
Radius of Gyration	<ul style="list-style-type: none"> Hyprotech proprietary method 	Default Only	<ul style="list-style-type: none"> Critical Temperature Critical Pressure Normal Boiling Point Molecular Weight Standard Liquid Density

In defining Hypothetical components, there are some properties for which you cannot select the estimation method. HYSYS determines the proper method based on information you have provided. The following table lists these properties and their respective default methods:

Property	Default Estimation Method
Liquid Enthalpy	<ul style="list-style-type: none"> The previously calculated Liquid Heat Capacity is used.
Vapour Enthalpy	<ul style="list-style-type: none"> Liquid Enthalpy + Enthalpy of Vapourization
Chao Seader Molar Volume	<ul style="list-style-type: none"> If $T_c > 300$ K, Molar Volume from COSTALD @ 25 °C and 1 atm is used all other cases, ρ_{LIQ} @ 60 °F is used
Chao Seader Acentricity	<ul style="list-style-type: none"> component acentric factor is used
Chao Seader Solubility Parameter	<ul style="list-style-type: none"> If $T_c > 300$K, Watson type Enthalpy of Vaporization is used all other cases, values of 5.0 are used

Property	Default Estimation Method
Cavett Parameter	<ul style="list-style-type: none"> • Two Reference Fluid¹ method (using benzene and carbazole)
Dipole Moment	<ul style="list-style-type: none"> • No estimation method available, sets value equal to zero.
Enthalpy of Combustion	<ul style="list-style-type: none"> • No estimation method available, sets value to <empty>.
COSTALD Characteristic Volume	<ul style="list-style-type: none"> • If NBP < 155 °F, Bergman is used • all other cases, Katz-Firoozabadi is used
Liquid Viscosity Coefficients A and B	<ul style="list-style-type: none"> • For non-Hydrocarbon or NBP < 270 K, Letsou Stiel is used • for Hydrocarbon and NBP < 335 K, NBS viscosity is used • all other cases, Twu is used.
Vapour Viscosity	<ul style="list-style-type: none"> • Chung
PRSV Kappa1	<ul style="list-style-type: none"> • Vapour Pressure from Antoine's Equation
Kfactor1	<ul style="list-style-type: none"> • Vapour Pressure from Antoine's Equation

3.4.3 UNIFAC Structure

Most of the estimation methods require a UNIFAC structure for some aspect of the estimation. It may be that either the property itself, or some other property that is affected by the estimation procedure requires the chemical structure.

The UNIFAC structure is supplied through the UNIFAC Component Builder. This can either be accessed by clicking the UNIFAC button in the Hypo Group view, or by clicking the Structure Builder button on the ID tab of the Hypothetical component property view. Whichever route is taken, the following view is displayed:

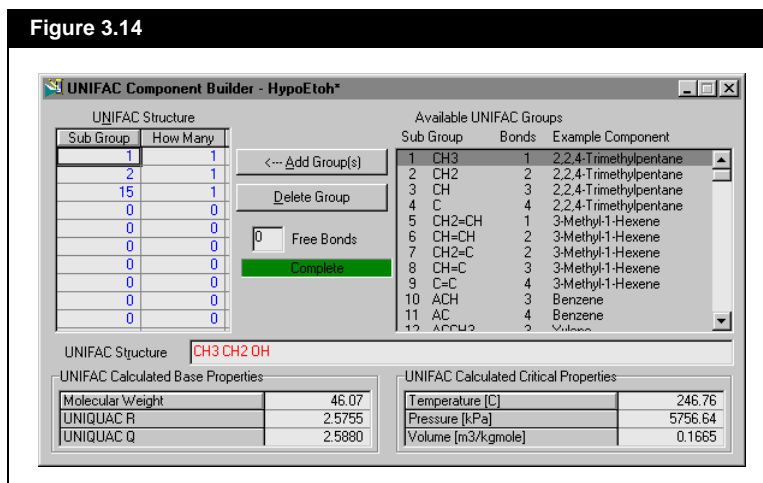

The UNIFAC Component Builder view is made up of the following objects:

Note that this section makes reference to both the UNIFAC Structure group (the table of cells) and the UNIFAC Structure entry field.

Objects	Description
UNIFAC Structure Group	Displays the Type and Number of Sub Groups in the UNIFAC Structure.
Add Group(s)	Adds the currently selected Sub Group from the Available UNIFAC Groups list box to the UNIFAC Structure group.
Delete Group	Deletes the currently selected Sub Group in the UNIFAC Structure group.
Free Bonds	Displays the number of free bonds available in the present UNIFAC Structure. This is 0 when the structure is complete.
Status Bar	This bar is found in the centre of the view. It indicates the present status of the UNIFAC Structure. You see either Incomplete in red, Complete in green, or Multi-Molecules in yellow.
Available UNIFAC Groups	Contains all the available UNIFAC component sub groups.
UNIFAC Structure field	Displays the chemical structure of the molecule you are building.

Objects	Description
UNIFAC Calculated Base Properties	Displays properties such as Molecular Weight, the UNQUAC R parameter, and the UNIQUAC Q parameter for a UNIFAC Structure with at least 1 sub group.
UNIFAC Calculated Critical Properties	Displays the critical properties for a UNIFAC Structure with at least 1 sub group.

The procedure for supplying the UNIFAC structure is to highlight the Sub Group(s) in the Available UNIFAC Groups column and select the Add Group(s) button. Additional sub groups can be accessed in the list by using the Scroll Bar.

As you add sub groups, HYSYS displays the number of Free Bonds available. This is zero when the UNIFAC structure is complete. When you have supplied enough groups to satisfy the bond structure, the status message changes to Complete (with a green background).

As you specify groups, the UNIFAC Calculated Base Properties and UNIFAC Calculated Critical Properties are automatically updated based on the new structure.

There are three methods available for adding Sub Groups to the UNIFAC Structure:

You can highlight more than one sub group, and add all at the same time.

Notice the difference between the UNIFAC Structure group (the table of cells) and the UNIFAC Structure entry field.

Sub Group	Description
Highlighting the Sub Group	The list of Available UNIFAC Groups displays all the sub groups. Notice that CH ₃ is the first selection in this list. You can use the scroll bars to move through the list until you find the group you need. When you find the correct Sub Group, highlight it, and click the Add Group(s) button. The sub group now appears in the UNIFAC Structure group.
Using the Sub Group Number	Each sub group has a number associated with it. If you know the number for the sub group you want to add to the UNIFAC Structure, move the active location to the Sub Group column of the UNIFAC Structure group. Enter the number of the Sub Group. HYSYS does not automatically fill in the number of sub groups. Move the active location to the How Many column and type in the number of sub groups required.
Typing in the UNIFAC Structure input field	Notice the UNIFAC Structure input field near the bottom of the view. Any sub groups already installed are listed here. Place the cursor after the last group, and type in the group to install. For example, if we want to add an OH group, type in OH. When you type the sub group in this box, HYSYS automatically adds it to the UNIFAC Structure group.

You can add multiples of a Sub Group in the UNIFAC Structure box. Type the number of Sub Groups and the Sub Group name, separated by a space. For example, type 3 CH2 to add three CH2 groups to the UNIFAC structure. NOTE: You cannot add Sub Groups in this way to an existing UNIFAC structure.

HYSYS automatically calculates Base Properties and Critical Properties using the currently supplied structure.

3.5 Hypothetical Component Property View

Hypotheticals, like library components, have their own property view. Once inside, you can add or modify information, or examine the results of the estimations.

You can access the property view for the Hypo component from different views:

View	Method of Accessing Hypo
Simulation Basis Manager, Hypotheticals Tab	All the hypothetical components are displayed in the Hypothetical Quick Reference group. You can either double-click on the component name, or highlight it and click the View Hypo button.
Hypo Group	All the hypothetical components in the Hypo Group you have chosen to view, are displayed. Either double-click on the Hypo component you want to view, or highlight it and click the View button.
Simulation Basis Manager, Components Tab	After adding a hypothetical to the Selected Component List group, highlight it and click the View Component button or object inspect its name and select View .

The Hypothetical property view is made up of five tabs and are shown below. Some of the tabs have radio buttons for switching between the various properties. When a different radio button is selected, HYSYS redraws the view with the information appropriate to the item.

Figure 3.15

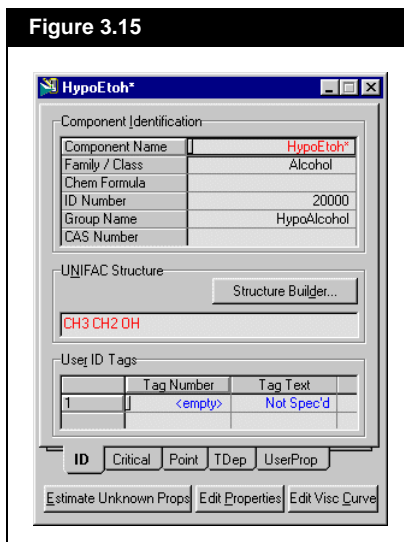

After you have entered adequate estimation parameters, you can click the Estimate Unknown Properties button to complete the hypothetical estimation. The Edit Properties button allows you to edit properties within the hypocomponent at the component level. The Edit Visc Curve button allows you to recalculate the viscosity coefficients based on the temperature and dynamic viscosity data provided by the user. Refer to [Edit Properties](#) in [Section 1.2.3 - Manipulating the Selected Components List](#) for more information.

Throughout the tabs of the property view, information is displayed in red, blue, and black. Values displayed in red are estimated by HYSYS and values displayed in blue are user supplied. Black values represent calculated values or information that you cannot modify (i.e., Family/Class on the ID tab).

You can supply values directly for any of the component properties, or overwrite values estimated by HYSYS. If you change a specified value, all properties previously estimated using that specification are forgotten. Click the Estimate Unknown Props button to have the properties recalculated.

3.5.1 ID Tab

The ID tab is the first tab in the Hypo property view. If it is the first time you are entering a Property View, HYSYS places you on this tab.

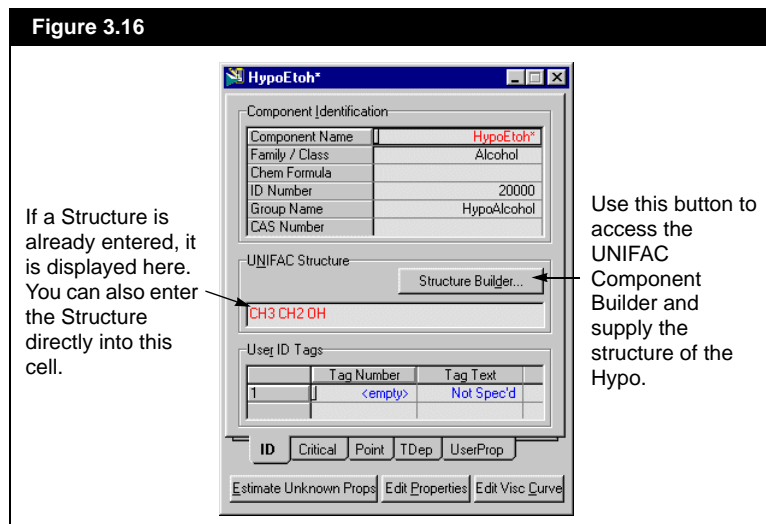

3.5.2 Critical Tab

The Critical tab of the property view displays the base and critical properties. This is the same information displayed on the Hypo Group when the Base Properties radio button is selected.

For more information on the Minimum Information required for Property Estimation see [Section 3.4.2 - Supplying Basic Information](#)

You can supply or change the Base Properties on this tab. The views, shown in [Figure 3.17](#), display the Critical tab before and after the Estimate Unknown Props button is clicked. Notice that since the Normal Boiling Point was less than 370 °C, only the Molecular Weight value was required for this estimation.

Figure 3.17

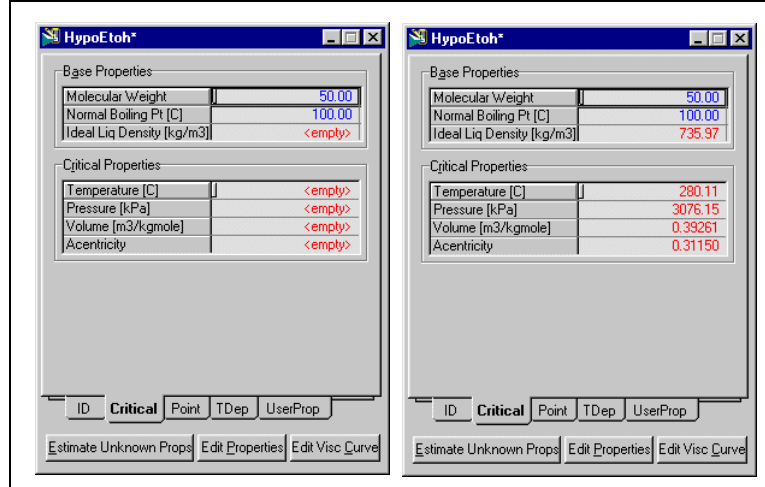

3.5.3 Point Tab

The Point tab displays Additional Point Properties for the hypothetical. There are two radio buttons on the view, which allow you to toggle between two tables of information are the:

- Thermodynamic and Physical Properties
- Property Package Molecular Properties

Thermodynamic & Physical Properties

This view displays the Thermodynamic and Physical properties for the Hypo. HYSYS estimates these values, based on the base property data entered and the selected estimation methods.

Figure 3.18

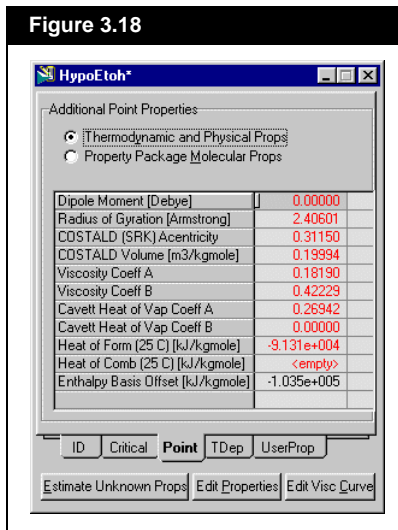

Notice that the Heat of Comb field is <empty>. This indicates that HYSYS cannot estimate this value with the given information. HYSYS allows you to input a value for this property.

The viscosity coefficients of A and B are first estimated by HYSYS based on the initial specifications from the Hypo Group view. If you want to calculate these coefficients, you can override the estimation by clicking the Edit Visc Curve button. This allows you to enter a set of data points of temperature versus dynamic viscosity.

Figure 3.19

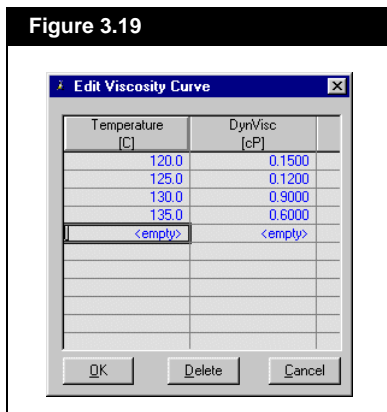

There are three buttons available in the Edit Viscosity Curve view:

Buttons	Descriptions
OK	Allows HYSYS to accept the data to perform the calculations.
Delete	Clears all the data points in the data table and closes the view automatically.
Cancel	Cancels the operation and exit the view. The data points you entered will not be used in the calculations but these points will be saved in the data table without being cleared so you can make modification later.

HYSYS will recalculate the values of the viscosity coefficients based on the data points you just entered. The values of the viscosity coefficients A and B will then change from red to black indicating that they are calculated values.

Property Package Molecular Props

This view displays the Molecular properties for the Hypo. The values estimated are dependent on the selected estimation method for each property.

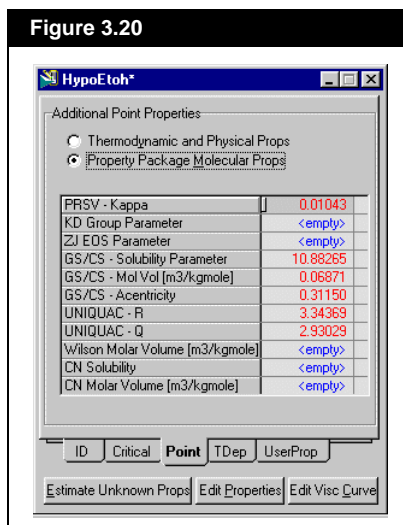

Some of the fields in this view are <empty>. This indicates that HYSYS cannot estimate these values with the information given. However, you can specify values for these properties.

3.5.4 TDep Tab

The TDep tab displays Temperature Dependent Properties for the hypothetical. There are three radio buttons on the view, which allow you to toggle between the three different displays of information. The views available are:

- Vapour Enthalpy
- Gibbs Free Energy
- Vapour Pressure

Vapour Enthalpy

The Vapour Enthalpy calculation is performed on a Mass Basis. The reference point for the equation is an ideal gas at 0 K. The units for Mass Vapour Enthalpy and Temperature are kJ/kg and degrees Kelvin, respectively.

Figure 3.21

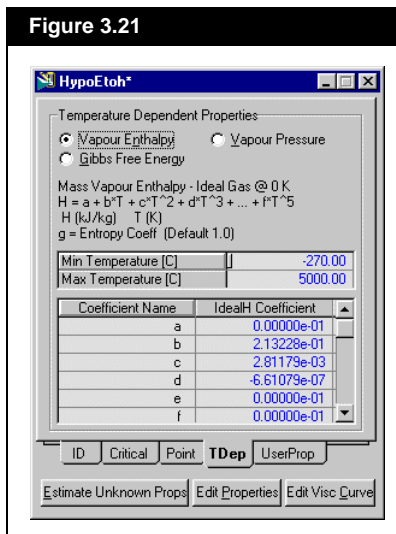

When required, the Vapour Enthalpy equation is integrated by HYSYS to calculate entropy. Note that if enthalpy coefficients are entered, a constant of integration, g , should be supplied along with the other coefficients. Specify this value in the g coefficient field.

Notice that HYSYS has estimated the Minimum and Maximum Temperatures.

Below the temperature range are values for the Vapour Enthalpy equation coefficients (from *a* to *g*). HYSYS estimates the coefficients, but you may change any of the values.

Vapour Pressure

The Vapour Pressure is calculated using the Modified Antoine equation. HYSYS estimates the Minimum and Maximum Temperature values based on the supplied properties and estimation methods.

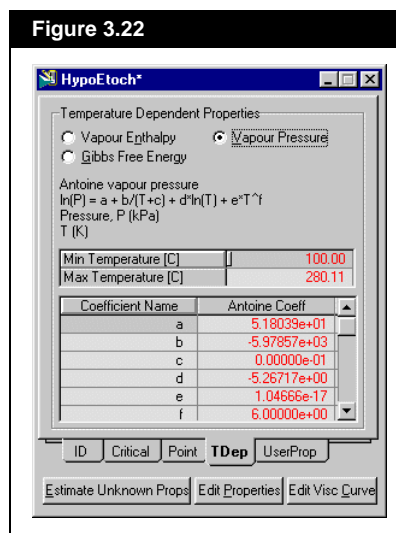

The units used for Pressure and Temperature are kPa, and degrees Kelvin, respectively.

The bottom section of this view displays the values for each of the Antoine equation coefficients (from *a* to *f*). HYSYS estimates the coefficients, however you can modify these values.

Gibbs Free Energy

The Gibbs Free Energy calculation uses Enthalpy as its property type and is performed on a Molar Basis. The basis for the equation is ideal gas at 25 °C. HYSYS estimates the Minimum and Maximum Temperature values.

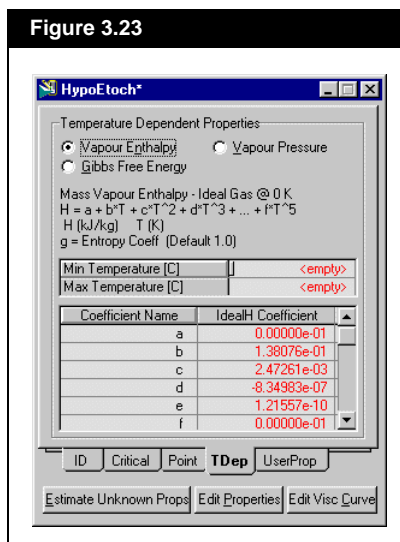

The units for Molar Enthalpy and Temperature are kJ/mole and degrees Kelvin, respectively.

The bottom section of the view displays the values for each of the Gibbs Free Energy equation coefficients (from *a* to *c*).

HYSYS estimates the Gibbs Free Energy coefficients if you supply the UNIFAC structure and enter the Ideal Gas Gibbs Free Energy at 25 °C in the *a* coefficient cell.

3.6 Solid Hypotheticals

Solids do not take part in VLE calculations, but they do have an effect on heat balance calculations.

Solid Hypotheticals can be added to any Hypo Group, regardless of the Group Type. In the Individual Hypo Controls group of the Hypo Group view, click the Add Solid button.

When you install a solid hypo, you notice that the Base Properties cells on the Hypo Group view are displayed as <empty>.

3.6.1 ID Tab

To define the Solid Hypo, access its property view by highlighting the component name on the Hypo Group view and clicking the View button.

The ID tab of the Solid Component property view is the same as that for other Hypo components except that the User Props tab is replaced by the PSD tab. Note that in this case, the Family/Class is Alcohol. The Class type has no effect on the values calculated for the solid component.

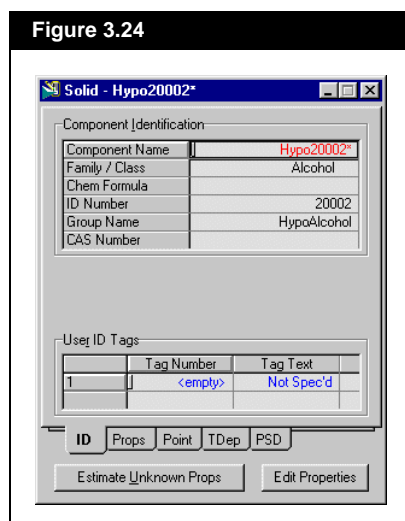

3.6.2 Props Tab

The Props tab displays the basic properties of the component in two groups:

- Solid Properties where bulk properties are entered
- Coal Analysis where data can be entered on a possible Coal Analysis

Solid Properties

The minimum information that must be supplied includes the Molecular Weight and the Density. The appropriate units can also be specified within the cell as shown below.

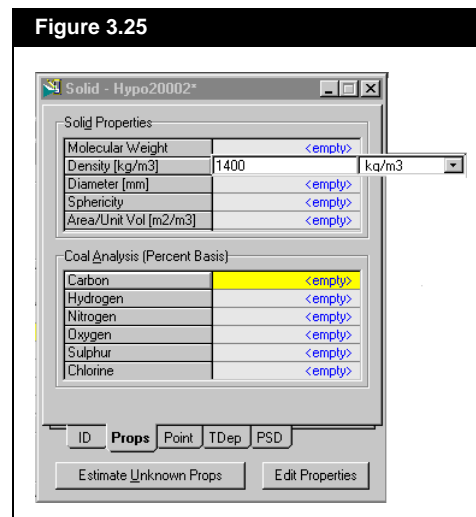

The other Solid Properties are described below:

Solid Property	Description
Diameter	Particle diameter, if not supplied this defaults to 1 mm when the remaining properties are estimated.
Sphericity	Value between zero and one, with one being perfectly spherical.
Area/Unit Volume	Measure of the surface area of the particle as a function of the particle volume.

Coal Analysis

You can also provide the results of a Coal Analysis on a percentage basis for the listed components.

3.6.3 Point Tab

The only information on the Point tab that is relevant to the Solid is the Heat of Combustion and Heat of Formation.

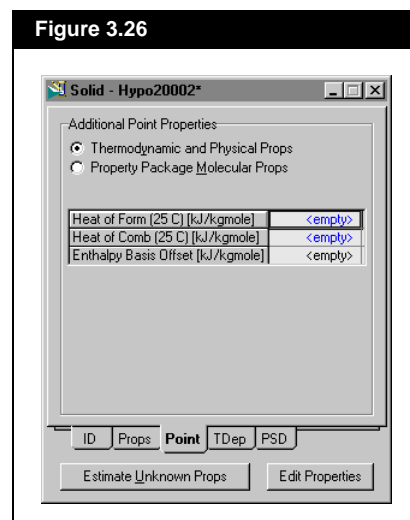

This information is only required if you plan on using a Solid component as part of a reaction.

3.6.4 TDep Tab

Note that while other Hypotheticals use the Ideal Gas Enthalpy coefficients, solids use the Specific Heat Capacity.

Since Solid Hypos do not participate in VLE calculations, their vapour pressure information is, by default, set to zero. However, since solid components do affect Heat Balances, the Specific Heat information can either be estimated by HYSYS, or supplied.

Figure 3.27

Temperature Dependent Properties

Specific Heat Vapour Pressure
 Gibbs Free Energy

Specific Heat - Mass Basis - Solid @ 25 C
 $C_p = a + b \cdot T + c \cdot T^2 + d \cdot T^3 + e \cdot T^4$
 Cp, in kJ/kg-K, T, in degree K
 f = Entropy Coeff (Default 1.0)

Min Temperature [C]	-270.00
Max Temperature [C]	5000.00

Coefficient Name	Solid Cp Coeff.
a	<empty>
b	<empty>
c	<empty>
d	<empty>
e	<empty>

ID Props Point **TDep** PSD

Estimate Unknown Props Edit Properties

3.6.5 PSD Tab

The PSD tab displays the particle size distribution for solids. It allows you to specify PSD's and calculate various mean and modal diameters for the entered PSD. The PSD tab is shown below.

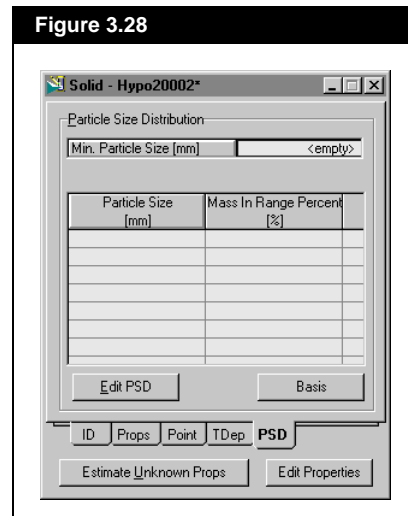

Refer to [Section 1.2.3 - Manipulating the Selected Components List](#) and see [UserProp & PSD Tabs](#) for more information on Particle Size Distribution.

3.7 Cloning Library Components

By using the Add New Hypo Group button, you do not have to return to the Simulation Basis Manager to create a Hypo Group.

You can convert HYSYS library components into Hypotheticals through the Clone Library Comps button on the Hypo Group view. When you click this button, the Convert Library Comps to Hypothetical Comps view is displayed. Any of the library components present in the current Fluid Package can be converted to a Hypothetical.

Figure 3.29

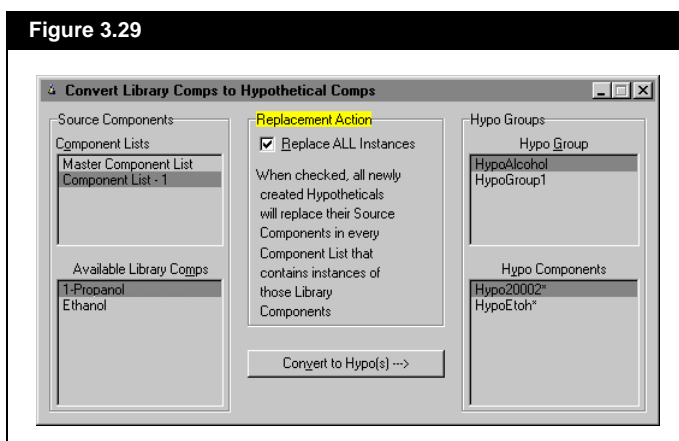

This view is made up of two sections, the Source Components group and the Hypo Groups.

Object	Description
Component Lists	Allows you to select the component list that contains the library component you want to clone.
Available Library Comps	Selects the component you want to convert into a hypothetical.
Replace ALL Instances	If you want to replace the library component with the Hypo in every Fluid Package that contains the library component, activate this checkbox. If you only want to replace the library components in the highlighted Fluid Package, do not activate the checkbox.
Hypo Group	Selects the Hypothetical Group in which you want the converted library component placed.
Hypo Components	Displays all the hypothetical components present in the selected hypothetical group. When a library component is converted into a hypothetical, it is listed here.

3.7.1 Converting a Library Component to a Hypo

When converting a library component to a Hypo, follow the procedure outlined below. [Figure 3.29](#) is used as a reference.

1. Select the **Component List** which contains the target library component. In this case, **Component List - 1** is the selected component list.
2. From the Available Library Comps group, select the component to clone. In this case, **1-Propanol** is selected.
3. Select the **Target Hypo Group**, where the new Hypo is to be placed. **HypoAlcohol** is selected.
4. Decide if you want to replace all instances of the source component (1-Propanol) with the new Hypo. Activate the **Replace All Instances** checkbox to do this. In [Figure 3.29](#) the checkbox is activated.
5. To complete the conversion, click the **Convert to Hypo(s)** button.
6. The new Hypo appears in the Hypo Components group, and has an asterisk (**1-Propanol***) after its name, signifying that it is a hypothetical.
7. Close the view to return to the Hypo Group view.

3.8 Hypo Controls

The manipulation commands for hypotheticals are contained on the Hypotheticals tab of the Simulation Basis Manager. The Hypo Controls are the buttons contained within the Hypothetical Quick Reference group as shown below:

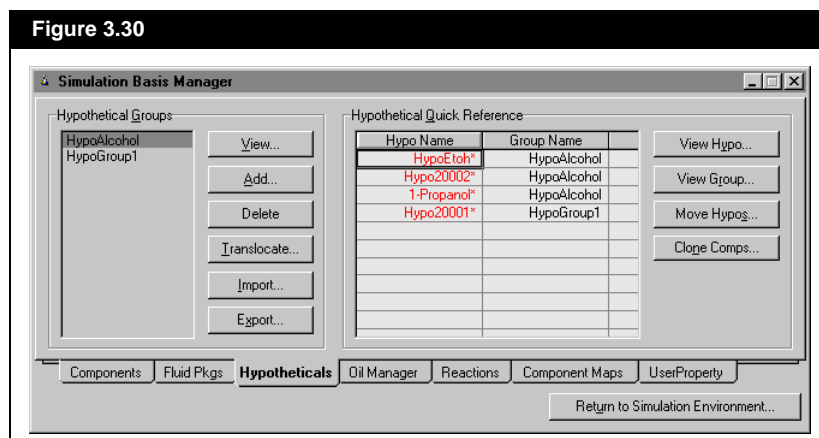

3.8.1 Viewing Groups

Notice that the Hypothetical Quick Reference group displays the names of hypothetical groups and components. The components are listed in the Hypo Name column and the group to which each component belongs is listed in the Group Name column.

From the Group Name column, select the Group that you want to view, and click the View Group button. HYSYS displays the Hypo Group view for that Hypo Group. All the Hypo components that are part of the group appear on this view.

3.8.2 Moving Hypos

By clicking the Add New Hypo Group button, HYSYS allows you to add a new Hypo Group while this view has focus.

When hypothetical components are created in HYSYS, they are created within a Hypo Group, and become part of the group. After adding a hypothetical component to a certain group, you may want to move it to another existing group. You can accomplish this through the Hypo Controls. From the Hypothetical Quick Reference group, click the Move Hypo button. This produces the following view:

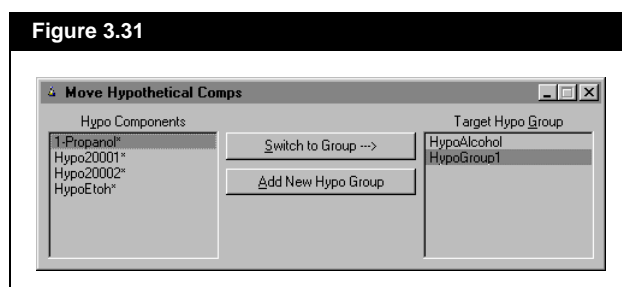

Follow this procedure to move a Hypo to a different Hypo Group:

1. From the Hypo Components group, select the Hypo that you want to move.
2. Select the Target Hypo Group to which the Hypo is being moved.
3. Click the **Switch to Group** button, which becomes available when a selection is made in both the Hypo Components group and Target Hypo Group.
4. When you are finished moving groups, close the view and return to the Hypotheticals tab of the Simulation Basis Manager.

3.9 References

- ¹ Reid, R.C., Prausnitz, J.M., Poling, B.E., The Properties of Gases & Liquids, 4th edition, McGraw-Hill, 1987.

4 HYSYS Oil Manager

4.1 Introduction	3
4.2 Oil Characterization	4
4.2.1 Laboratory Data.....	4
4.2.2 Conventional Distillation Data	5
4.2.3 Data Reporting Basis	7
4.2.4 Physical Property Assay Data	7
4.2.5 Property Curve Basis	7
4.2.6 Common Laboratory Data Corrections.....	8
4.2.7 Default Correlations.....	8
4.3 Petroleum Fluids Characterization Procedure	9
4.3.1 Initialization.....	9
4.3.2 Step One - Characterize Assay.....	11
4.3.3 Step Two - Generate Hypocomponents	11
4.3.4 Step Three - Install Oil.....	11
4.3.5 User Property	12
4.3.6 Correlations	12
4.4 Oil Characterization View	13
4.5 Characterizing Assays	16
4.5.1 Input Data Tab	19
4.5.2 Calculation Defaults Tab.....	42
4.5.3 Working Curves Tab	46
4.5.4 Plots Tab.....	47
4.5.5 Correlations Tab	48
4.5.6 User Curves Tab.....	49
4.5.7 Notes Tab	50

4.6 Hypocomponent Generation	51
4.6.1 Data Tab.....	52
4.6.2 Correlations Tab.....	59
4.6.3 Tables Tab.....	60
4.6.4 Property Plot Tab	61
4.6.5 Distribution Plot Tab	63
4.6.6 Composite Plot Tab	64
4.6.7 Plot Summary Tab.....	65
4.6.8 Notes Tab.....	66
4.7 User Property.....	66
4.7.1 User Property Tab	66
4.7.2 User Property View	67
4.8 Correlations & Installation.....	70
4.8.1 Correlation Tab.....	70
4.8.2 Correlation Set View	71
4.8.3 Install Oil Tab	75
4.9 TBP Assay - Example.....	76
4.9.1 Initialization	78
4.9.2 Step 1 - Input Assay Data	80
4.9.3 Step 2 - Cut Assay into Hypocomponents	87
4.9.4 Step 3 - Transfer Information to Flowsheet.....	90
4.9.5 Fluid Package Association	92
4.10 Sulfur Curve - Example	93
4.10.1 Fluid Package	93
4.10.2 Install a User Property	94
4.10.3 Install the Assay	95
4.10.4 Create the Blend	97
4.10.5 Results	98
4.11 References	100

4.1 Introduction



Oil Environment Icon

The Oil Characterization environment can be accessed from the Oil Manager tab of the Simulation Basis manager or by clicking the Oil Environment icon on the toolbar. To enter the Oil Characterization environment, at least one fluid package must exist in the case. Hypothetical (pseudo) components must be compatible with the property method being used by the fluid package.

Also on the Oil Manager tab, you can view all flowsheets that exist in the current case and the fluid package associated with each. All hypocomponents that are defined within the Oil Characterization environment are assigned to a Hypo group and installed in an associated fluid package. Since Light End calculations for an oil require information from the property method being used by the associated fluid package, the hypocomponent cannot be shared among different fluid packages as regular hypothetical components can. However, you can still use the same hypocomponent in the non-associated fluid packages by adding them as hypotheticals, via the Add Hypo or Add Group button on the Selected tab of the Component List property view.

Refer to [Chapter 3 - Hypotheticals](#) for more information on hypo controls.

The Oil Characterization environment provides a location where the characteristics of a petroleum fluid can be represented by using discrete hypothetical components. Physical, critical, thermodynamic and transport properties are determined for each hypothetical component using correlations that you select. The fully defined hypocomponent can then be installed in a stream and used in any flowsheet.

HYSYS defines the hypocomponent by using assay data which you provide. The features available for the input of assay data minimize the time required for data entry. For instance, defined assays can be cloned, imported and exported. Exported assays can be used in other fluid packages or in other cases altogether.

Some of the features exclusive to the oil environment include:

- Providing laboratory assay data
- Cutting a single assay
- Blending multiple assays
- Assigning a user property to hypocomponents
- Selecting correlation sets to determine properties
- Installing hypocomponent into a stream
- Viewing tables and plots for your input and for the characterized fluid

4.2 Oil Characterization

The petroleum characterization method in HYSYS converts your laboratory assay analyses of condensates, crude oils, petroleum cuts, and coal-tar liquids into a series of discrete hypothetical components. These petroleum hypocomponents provide the basis for the property package to predict the remaining thermodynamic and transport properties necessary for fluid modeling.

HYSYS produces a complete set of physical and critical properties for the petroleum hypocomponent with a minimal amount of information. However, the more information you can supply about the fluid, the more accurate these properties are, and the better HYSYS predicts the fluid's actual behaviour.

4.2.1 Laboratory Data

The Watson (UOP) K factor is an approximate index of paraffinicity, with high values corresponding to high degrees of saturation:

$$K = \frac{(\text{Mean Avg. BP})^{\frac{1}{3}}}{sp\ gr\ 60F / 60F}$$

where the mean average boiling point is in degrees Rankine.

Accurate volatility characteristics are vital when representing a petroleum fluid in your process simulation. HYSYS accepts five standard laboratory analytical assay procedures:

- True boiling point distillation (TBP)
- ASTM D86 and ASTM D1160 distillations (Separately or Combined)
- ASTM D2887 simulated distillation
- Equilibrium flash vapourization (EFV)
- Chromatographic analysis

The characterization procedure performs its calculations based on an internally calculated TBP curve. If you supply an ASTM or EFV distillation curve, it is converted to a TBP curve using standard methods described in the API Data Book. If you do not supply any distillation data, then an average TBP distillation curve is generated for you based on the overall molecular weight, density, and Watson (UOP) K factor of your fluid.

4.2.2 Conventional Distillation Data

The five primary types of assay data accepted by the Petroleum Characterization Procedure in HYSYS are listed here and explained in the following sections.

- True Boiling Point analysis
- ASTM D86 and 1186 Distillations
- ASTM D2887
- Equilibrium Flash Vaporization
- Chromatographic analysis

True Boiling Point (TBP) Analysis

A TBP analysis is performed using a multi-stage batch fractionation apparatus operated at relatively high reflux ratios (15 - 100 theoretical stages with reflux ratios of 5 to 1 or greater). TBP distillations conducted at either atmospheric or vacuum conditions are accepted by the characterization procedure.

Note that the initial boiling point (IBP) of a TBP curve does not correspond to the bubble point temperature of the petroleum fluid at atmospheric pressure.

The petroleum fluid's bubble point is a multi-component equilibrium condition such that there is an incipient vapour phase forming. This would, in effect, be a single-stage of fractionation as opposed to the highly refluxed operation of a TBP analysis.

ASTM D86 and D1160 Distillations

ASTM D86 and ASTM D1160 distillations also employ batch fractionation apparatus, but they are conducted using non-refluxed Engler flasks. Two standard ASTM distillations are supported: ASTM D86, used for light to medium petroleum fluids, and ASTM D1160, carried out at varying vacuum conditions and used for heavier petroleum fluids. For ASTM D86 distillation, HYSYS can correct for barometric pressure or cracking effects.

ASTM D2887

ASTM D2887 is a simulated distillation curve generated from chromatographic data. The resulting boiling point curve is reported on a weight percent basis.

Equilibrium Flash Vaporization

An EFV curve is generated by a series of experiments conducted at constant pressure (1 atm). The results relate the temperature versus volume percent of liquid distilled, where the total vapour is in equilibrium with the unvaporized liquid.

Chromatographic Analysis

A Chromatographic analysis is a simulated distillation performed by passing a small amount of totally vaporized sample through a packed gas chromatograph column. The relative amounts of the sample that appear in each standard "chromatographic" hydrocarbon group (paraffinic, aromatic and naphthalene groups, ranging from C6 to C30) are then detected and reported.

4.2.3 Data Reporting Basis

All of the distillation analyzes described above are reported using one of the following fractional bases (assay basis):

- Liquid volume percent or liquid volume fractions
- Mole percent or mole fractions
- Mass percent or mass fractions

HYSYS accepts TBP and Chromatographic analyzes in any one of the three standard bases. However, due to the form of the API Data Book conversion curves, EFV, ASTM D86 and ASTM D1160 distillations must be supplied on a liquid volume basis, and ASTM D2887 are only reported on a weight basis.

4.2.4 Physical Property Assay Data

As you supply more information to HYSYS, the accuracy of the Petroleum Characterization increases. Supplying any or all of bulk molecular weight, bulk density or bulk Watson (UOP) K factor increases the accuracy of your hypocomponent properties. Appropriately, if you supply laboratory curves for molecular weight, density and/or viscosity, the accuracy increases further.

If you cannot supply property curve data, HYSYS generates internal curves using the available information. This information is applied using correlations. You can change the default set of property correlations as required.

4.2.5 Property Curve Basis

Physical property analyzes are normally reported by a laboratory using one of the following two conventions:

- An Independent assay basis where the property assay volume fractions do not correspond on a one-to-one basis with the distillation assay fractions.
- A Dependent assay basis, where a common set of assay fractions are utilized for both the distillation curve and the physical property curves.

Refer to [Appendix B - Petroleum Methods/Correlations](#) for information on the correlations used in the Oil Environment.

Note that physical properties are average values for the given range, and hence are midpoint values. Distillation data reports the temperature when the last drop of liquid boils off for a given assay range; therefore distillation is an endpoint property. Since all dependent input property curves are reported on the same endpoint basis as the distillation curve, they are converted by HYSYS to a midpoint basis. Independent property curves are not altered in any manner before being used in the characterization, since they are already defined on a midpoint basis.

4.2.6 Common Laboratory Data Corrections

With ASTM D86 data, correction procedures are available to modify the laboratory results for both barometric pressure and thermal cracking effects, which result in the degradation of the sample at high distillation temperatures. These corrections are sometimes performed by the laboratory. If the corrections have not already been applied, the Characterization procedure has options available to apply the necessary corrections before commencing calculations.

4.2.7 Default Correlations

When you begin a petroleum characterization session, HYSYS already has a set of default correlations for generating physical and critical properties of the hypocomponent. You may change any of the correlations at any time.

Refer to [Section 4.8.2 - Correlation Set View](#) for a listing of available correlations or [Appendix B - Petroleum Methods/Correlations](#) for a description of each correlation.

4.3 Petroleum Fluids Characterization Procedure

4.3.1 Initialization

Before entering the Oil Characterization environment, you are required to create a fluid package with a specified Property Package at the very minimum. Note that the Associated Property Package must be able to handle hypothetical components (i.e., a Steam Package is not allowed).

If you want to use library components to represent the Light Ends portion of your assay, it is best to select the components prior to entering the Oil Characterization environment (if you forget to do this, you can return later to the Components tab and select the components).

The fluid package that is used in the Oil Characterization environment is displayed in the Associated Fluid Package drop-down list on the Oil Manager tab of the Simulation Basis Manager view.

The **Oil Manager** tab of the Basis Manager view is shown below:

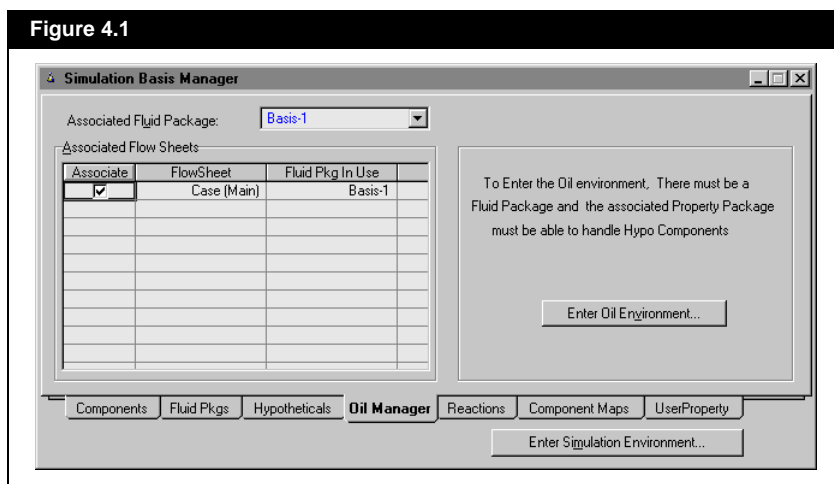

The Associated Fluid Package for the Oil serves two primary functions:

- Provides the light end components.
- Identifies to which Fluid Package the Hypo group (oil) is being installed.

When you install the oil into a stream, HYSYS always places this stream in the main flowsheet. For this reason, the associated Fluid Package must be the fluid package used by the main flowsheet.

If you also want to install the hypocomponent into a subflowsheet, this must be done on the Components tab of the Sub-Flowsheet fluid package (Hypothetical page, Add Group or Add Hypo button). If the sub-flowsheet uses the same fluid package as the main flowsheet, then this action is not necessary, as the hypocomponent is added to the fluid package once an oil stream is installed.

If you are going to transfer an oil stream between flowsheets with different fluid packages, ensure that the hypocomponent is installed in each flowsheet fluid package. Note that if you have not defined the same components in each fluid package, HYSYS will transfer only the compositions for those components that are available, and will normalize the remaining compositions.

The fluid package that is used in the Oil Characterization environment can be selected from the Associated Fluid Package drop-down list. To enter the Oil environment, select the Enter Oil Environment button as shown in [Figure 4.1](#), or select the Oil Environment button from the toolbar. The following figure illustrates the make-up of a typical oil:

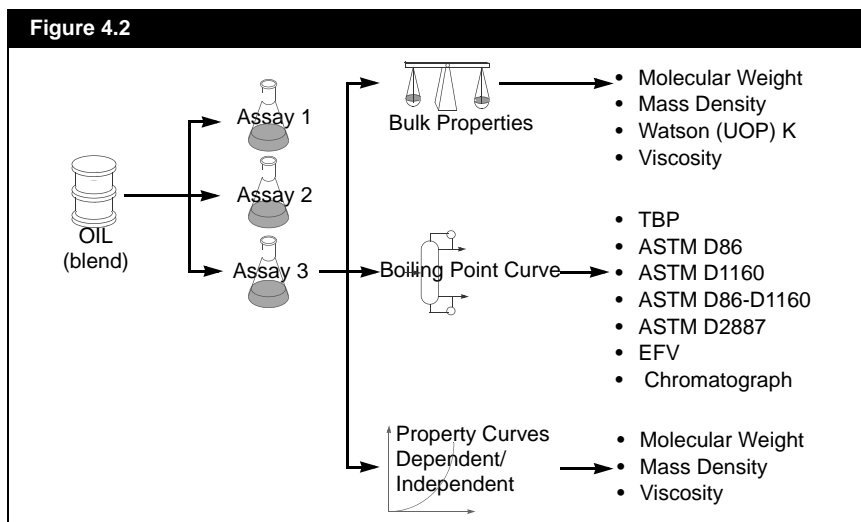

An Oil or Blend is comprised of any number of Assays. Each individual Assay contains specific information with respect to the Bulk Properties, Boiling Point Curve and Property Curves. For the Bulk Properties, you may supply Molecular Weight, Mass Density, Watson (UOP) K factor and/or Viscosity. You can provide the Boiling Point curve in any one of the formats displayed in the [Figure 4.2](#). During calculations, HYSYS automatically converts all curves to a TBP basis. You also have the option of supplying Molecular Weight, Mass Density, and/or Viscosity curves.

It is a good idea to open the Trace Window before you start the characterization, since it displays important information during Oil Characterization calculations.

There are three general steps you must follow when creating an oil:

1. characterize assay
2. generate hypocomponent
3. install oil in flowsheet.

4.3.2 Step One - Characterize Assay

Enter the petroleum assay data into HYSYS via the Assay tab of the Oil Characterization view. HYSYS uses the supplied Assay data to generate internal TBP, molecular weight, density and viscosity curves, referred to as Working Curves. See [Section 4.5 - Characterizing Assays](#) for more details.

4.3.3 Step Two - Generate Hypocomponents

Hypocomponents are generated from the Working Curves via the Cut/Blend tab of the Oil Characterization view. This process is explained in [Appendix B - Petroleum Methods/Correlations](#). See [Section 4.6 - Hypocomponent Generation](#) for the procedure.

4.3.4 Step Three - Install Oil

Once the Blend is characterized satisfactorily, install hypocomponent into your HYSYS case via the Install Oil tab of the Oil Characterization view. You can install the oil as a defined stream by providing a Stream name. The hypocomponent is also added to a distinct Hypo group and to the associated fluid package. See [Section 4.8.3 - Install Oil Tab](#) for more details.

4.3.5 User Property

In addition to the three basic steps required to characterize an oil in HYSYS, user properties can be added, modified, deleted, or cloned. User Properties can be created from the Oil Manger or in the Basis Environment. A user property is any property that can be calculated on the basis of composition. Refer to [Section 4.7 - User Property](#) for more information.

4.3.6 Correlations

Correlations can be selected via the Correlation tab of the Oil Characterization view. HYSYS allows you to select from a wide variety of correlations used in both the determination of working curves and in the generation of hypocomponent. See [Section 4.8.1 - Correlation Tab](#).

All of the information used in generating your hypocomponent is stored with the case. This includes: Assays and their associated Options, Property Curves and Bulk Properties, User Properties, the Correlations used for generating the pseudo-components, the Constituent oils (with flow rates) for blends, and the flowsheet stream in which each oil was installed. This information is available the next time you open the case.

4.4 Oil Characterization View

When you enter the Oil Characterization environment, the following view appears:

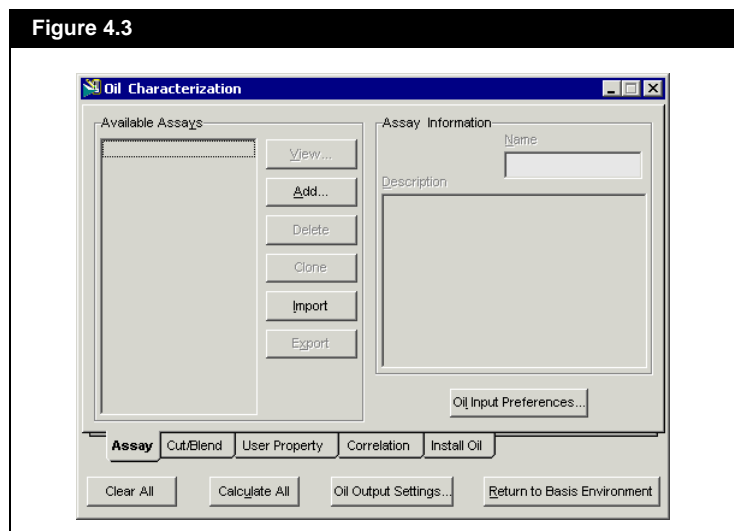

This view is the Oil Characterization environment. There are five tabs which represent the main areas of the environment and are described below:

Tab	Description
Assay	Add, edit, delete, clone, import or export Assays (see Section 4.5 - Characterizing Assays).
Cut/Blend	Add, edit, delete or clone Blends (see Section 4.6 - Hypocomponent Generation).
User Property	Add, edit, delete or clone User Properties (see Section 4.7 - User Property).
Correlation	Add, edit, delete or clone Correlation Sets (see Section 4.8.1 - Correlation Tab).
Install Oil	Install hypocomponent into a stream in a HYSYS case (see Section 4.8.3 - Install Oil Tab).

The Clear All, Calculate All, and Oil Output Settings... buttons are available on any tab of the Oil Characterization property view.

- If you select the **Calculate All** button, HYSYS calculates all Assays and Blends. This option is useful if you have several Assays and/or Blends and you want to see the global effect of a change in the correlation.
- If you select the **Clear All** button, HYSYS displays the following warning:

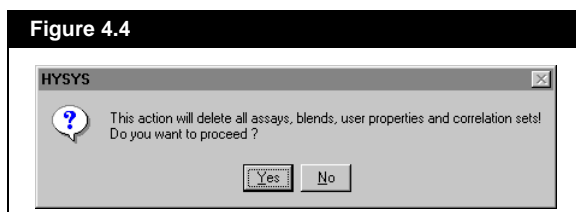

If you want to delete all Oil Characterization information select **Yes**.

- Selecting the **Oil Output Settings...** button results in the Oil Output Settings property view.

Oil Output Settings View

On this view, you can set the initial boiling point (IBP) and final boiling point (FBP) cut points on a liquid volume, mole or mass percentage basis. These values are used to determine the initial and final boiling temperatures of the TBP working curve. The default values are 1% for the IBP and 98% for the FBP.

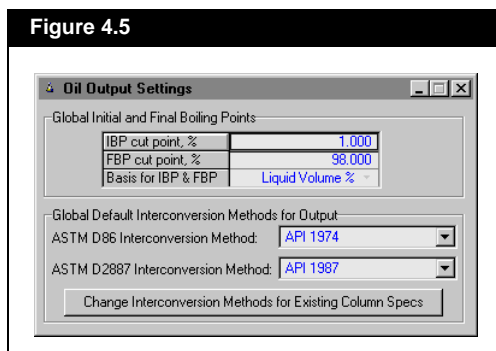

If for example, an IBP value of 1% is specified, the initial boiling point becomes the weighted average boiling temperature of all components that boil off in the first volume percent. The final boiling point is determined in a similar manner. If 98% is used for the FBP, the final boiling temperature becomes the weighted average boiling temperature of all the components that boil off in the last 2 volume percent. The ends of the curve are 'stretched' to fill the assay range of 0 to 100%.

Oil Input settings are accessed through the Preferences view.

On the Oil Output Settings view, you can select the default ASTM D86 Interconversion Method TBP conversion type from the Default D86 Curve Type drop-down list:

- API 1974¹
- API 1987²
- API 1994³
- Edmister-Okamoto 1959⁴

You can also select the ASTM D2887 Interconversion method from the following:

- API 1987⁵
- API 1994 Indirect⁶
- API 1994 Direct⁷

The Oil Output Settings are saved along with your simulation case. They can be accessed either within the Oil manager or through the Simulation menu bar option in the Main Simulation environment.

Changing the IBP and FBP in the Oil Output Settings will affect the following calculations:

- Blend Properties Table and Plots
- Boiling Point Utility
- Cold Properties Utility
- Column specs (Cut Point, Gap Cut Point, Flash Point, RON Point)
- Column Profiles

When IBP and FBP changes are made, all necessary calculations are automatically performed.

Note that the ASTM D86 and ASTM D2887 interconversion methods do not affect column specifications, since each related columnspec has its own independent setting. If you want to change the column specifications, click the Change Interconversion Methods for Existing Column Specs button. HYSYS asks you to confirm that you want to globally impose these changes.

4.5 Characterizing Assays

Refer to [Section 4.9 - TBP Assay - Example](#) for characterizing assays.

The Assay tab of the Oil Characterization view is shown below:

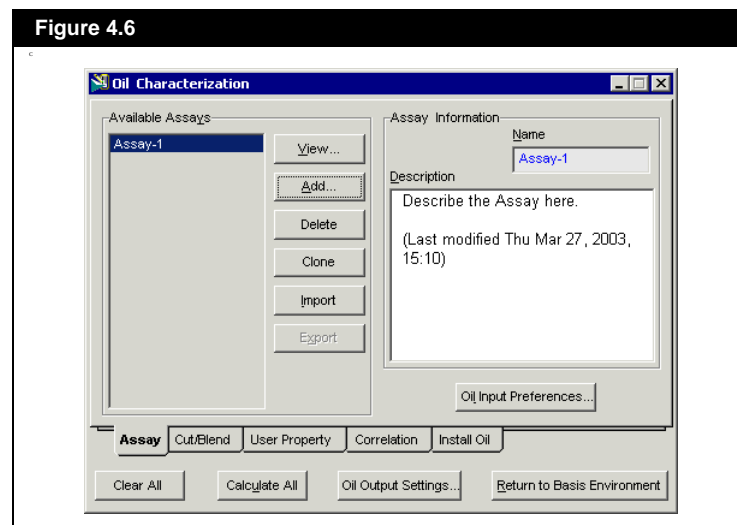

HYSYS does not prompt for confirmation when deleting an assay, so be careful when you are using this command. However, HYSYS does not delete an assay that is being used by a blend.

The Available Assays are listed in the left portion of the view. The following Assay manipulation buttons are available:

Button	Description
View	Edit the currently highlighted Assay
Add	Create a new Assay
Delete	Erase the currently highlighted Assay
Clone	Create a new Assay with the same properties as the currently highlighted Assay. HYSYS immediately opens a new Assay view

Imported and Exported assays have a filename form *.oil.

Button	Description
Import	Bring a saved assay into the current case
Export	Save an assay to disk so that it can be used in other cases

Note that for a highlighted Assay, you can edit the name in the Name field and provide a description in the Description textbox found in Assay Information group.

To create a new assay or edit an existing assay you can click the Add or View buttons, respectively. This opens the Assay property view for the new or existing assay.

When the Oil Input Preferences button under the Assay Information group is selected, the Session Preferences view opens to the Oil Input tab. From here you can set the input defaults for your case.

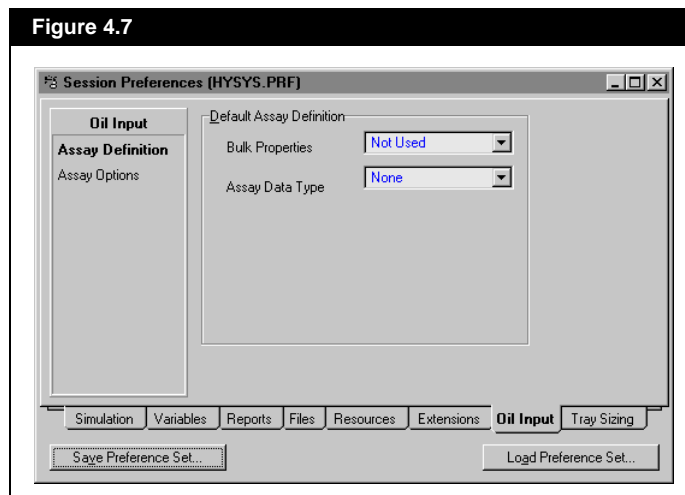

When a new case is created, the methods specified in the Oil Input settings initialize the Oil Output settings. However, any changes made afterwards to either settings group are independent.

Assay Property View

The Assay property view is shown below:

Note that the appearance of the Assay property view depends on how you define the assay in the Assay Definition group and which radio button is selected in the Input Data group.

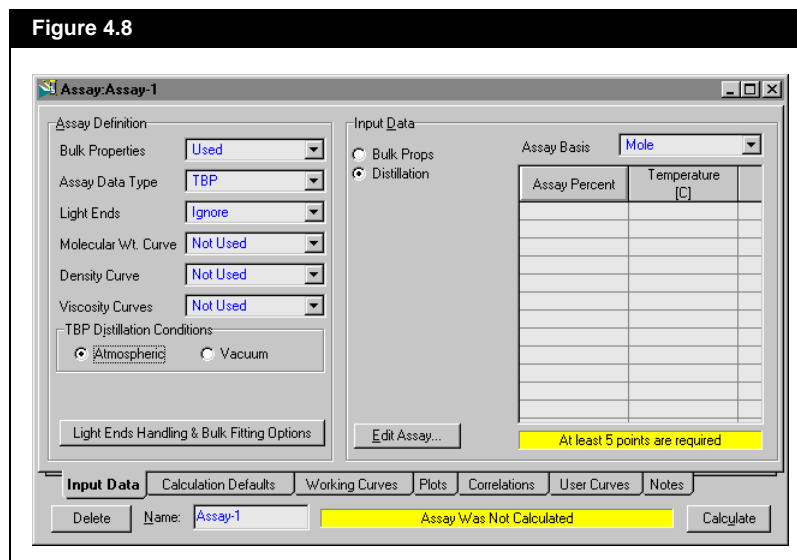

The Assay property view consists of seven tabs, which are described below:

Tab	Description
Input Data	Allows you to define and specify the Assay.
Calculation Defaults	Allows you to set the calculation methods and extrapolation methods for the assay and assay property curves.
Working Curves	Displays a table of Assay Working curves.
Plots	Allows you to view any of the input assay curves in graphical form.
Correlations	Allows you to edit the individual property conversion methods used.
User Curves	Allows you to attach available user properties to the assay.
Notes	Allows you to attach relevant comments to the assay.

There are four objects found at the bottom of the property view and are described below:

Object	Description
Name	You can provide the name of the Assay in the Name cell (maximum 12 characters).
Assay Status	The status bar is displayed at the bottom of the screen: <ul style="list-style-type: none"> • Assay Was Not Calculated. You have not provided enough Assay information to determine a solution (or you have enough information and have not clicked the Calculate button). • Assay Was Calculated. You have provided Assay information, clicked the Calculate button, and obtained a solution. • An Error Was Found During Calculation. The Trace Window usually shows a description of the type of Error.
Calculate	Select this button to calculate the Assay.
Delete	Select this buttons to delete the current Assay.

There is no confirmation when you delete an assay, unless it is being used by a blend, in which case you cannot delete it.

The following sections outline each of the tabs contained within the Assay view (accessed via the View or Add button).

4.5.1 Input Data Tab

The minimum amount of information that HYSYS requires to characterize a petroleum fluid is either:

- a laboratory distillation curve

OR

- **two** of the following three bulk properties:
 - Molecular Weight
 - Density
 - Watson (UOP) K factor

The Watson (UOP) K factor is an approximate index of paraffinicity, with high values corresponding to high degrees of saturation:

$$K = \frac{\sqrt[3]{\text{Mean Avg. BP}}}{sp\ gr\ 60F / 60F}$$

where the mean average boiling point is in degrees Rankine.

However, any additional information such as distillation curves, bulk properties and/or property curves, should be entered if possible. With more supplied information, HYSYS produces a more accurate final characterization of your oil.

When you open the Assay view to the Input Data tab, all that is displayed is the Assay Data Type and Bulk Properties drop-downs. New input fields are added as you specify the information for your oil.

The Input Data tab is shown below:

Figure 4.9

The layout of Input Data group depends largely on the settings you choose in this group.

Depending on the specifications made in the Assay Definition group. These radio buttons become visible. Each radio button makes a different entry field visible.

Specify which individual Input Data curves are to be included.

Options related to the Assay Data Type are displayed in this area.

The entry fields displayed in this table depend on which radio button is selected.

Assay Percent	Temperature [C]
0.0000	-9.444
4.500	32.22
9.000	73.89
14.50	115.6
20.00	154.4
30.00	223.9
40.00	273.3
50.00	326.7
60.00	393.3
70.00	473.9
76.00	520.6
80.00	546.1

For each of the three property curves, Molecular Weight, Density and Viscosity, you have the following options: Not Used, Dependent, or Independent. If you switch the status to Not Used after you have entered assay data, all your data for that property curve is lost when you return your selection to Dependent or Independent.

The Input Data tab is split into two groups: the Assay Definition and Input Data groups. The Assay Definition group is where the assay type and use of property curve, light ends data and bulk properties are defined. The Input Data group is where the distillation, property curve, light ends and property data is actually inputted.

Light Ends Handling & Bulk Fitting

If you have a light-ends analysis along with light-ends free input curves and total bulk properties or light-ends free bulk properties you can use the HYSYS oil manager to combine the light-ends analysis with the light-ends free input curves to match the specified bulk properties. This functionality is clearly seen in the case of chromatographic input, where you may want to input the light-ends along with the C6+ as the chromatographic data groups. Because of the nature of the analysis, the chromatographic data is light-ends free.

Light Ends Analysis Versus Calculated TBP Curve

Ideally, for the light-ends free distillation input curve, the TBP at 0% should coincide with the highest NBP in the light-ends components with non-zero compositions, see Case B in [Figure 4.10](#). However, due to imperfect input data or extrapolation, the calculated TBP at 0% may be lower than the top NBP for light ends (Case A in [Figure 4.10](#)) or higher than the top NBP for light ends (Case C in [Figure 4.10](#)). To avoid overlapping or discontinuity, these two cases must be properly handled.

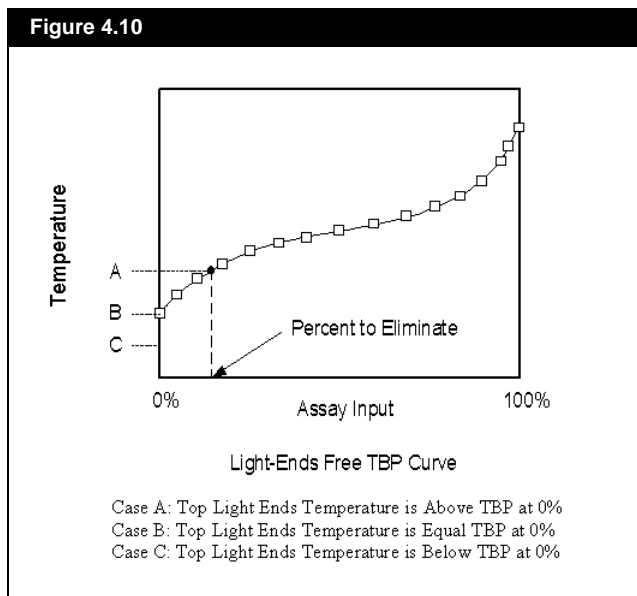

In Case A, the highest temperature of the non-zero component in light ends is above the TBP at 0%. In this case, we need to eliminate the points having TBP lower than the top light-ends temperature. After the elimination, the remaining portion of the light-ends free TBP curve are re-scaled to 100%, and then a new set of standard 51 points calculation tables are regenerated from the remaining portion of the corresponding curves.

In Case C, the top light-ends temperature is below the TBP at 0%. Since the extrapolation may not be accurate, more trust is put on the light-ends analysis and hence assign the top light-ends temperature as the TBP at 0%. To avoid a sudden jump in the distillation curve, the first 20% of the distillation curve is also smoothed.

Curve Partition for Bulk Property Fitting

To allow piece-wise fitting for a bulk property, a property curve is divided into three sections: head, main, and tail. The ending % of the head section and beginning % of the tail section can be specified. Each section can have an independent adjusting weight factor as shown in the figure below.

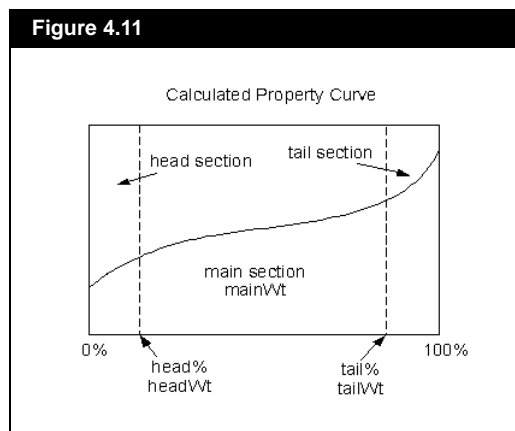

For piecewise bulk property fitting there are two concerns to be addressed. First, since each section can have an independent adjusting weight factor, there may be a discontinuity at the boundary of the two sections. Second, how to ensure relatively fast convergence with uneven adjustment of the property concerned. For the first concern, discontinuity is avoided by using linear interpolation between two sections. For the second concern, the weight factor is normalized first and then the following equation is used to calculate the new point property value from the old point property value:

$$New[i] = [1 + Wt[i] \times (Ratio - 1)] \times Old[i] \tag{4.1}$$

where: *New[i]* = the new property value at point *i*

Wt[i] = the normalized weight factor at point *i*

Ratio = the calculated uniform adjusting ratio

Old[i] = the old property value at point *i*

HYSYS allows you to specify if a given curve contains light-ends contributions, set if a specified bulk property contains light-ends and partition a property curve so that some sections can be adjusted more than others.

The Light Ends Handling & Bulk Fitting Options view is accessed by clicking the Light Ends Handling & Bulk Fitting Options button.

Figure 4.12

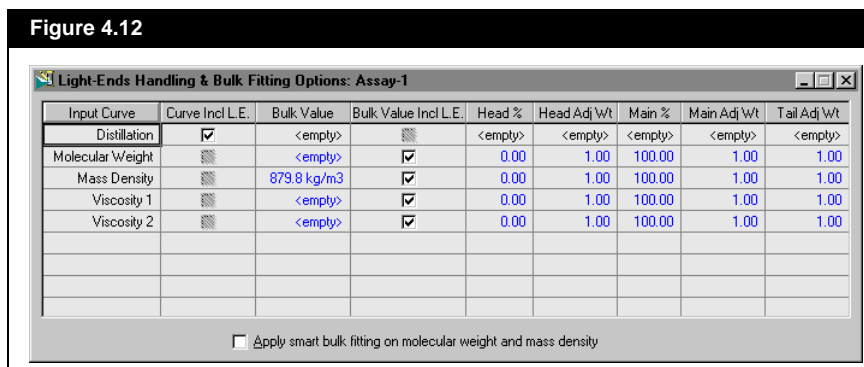

The light ends handling and bulk fitting options are described below:

Column	Description
Input Curve	Displays all the possible input curves, including user property curves.
Curve Incl L.E.	Specifies if the corresponding input curve includes light ends. If an input curve is not used, the corresponding checkboxes are grayed out.
Bulk Value	Specifies the bulk value for the corresponding input curve.
Bulk Value Incl L.E.	Specifies if a given bulk value contains the contributions of light ends. If no light end compositions are given these checkboxes are grayed out.

The last five columns are used for piece-wise bulk property fitting. When fitting a given bulk property value the internal calculation curve, either based on the input curve or calculated from a correlation, is divided into three sections. Each of the three sections can be independently adjusted.

Column	Description
Head%	Specifies the ending percent for the head section on the input basis.
Head Adj Wt	Specifies the corresponding relative bulk fit adjusting weight factor from 0 to 10, where 0 means no adjusting at all.
Main%	Specifies the ending percent for the main section of the input basis.
Main Adj Wt	Specifies the corresponding relative bulk fit adjusting weight factor from 0 to 10, where 0 means no adjusting at all.
Tail Adj Wt	Specifies the corresponding relative bulk fit adjusting weight factor from 0 to 10, where 0 means no adjusting at all.

When fitting a given bulk value, at least one section must be adjustable. Therefore, at least one section must have a non-zero percentage range and a non-zero adjusting weight factor. Since the adjusting weight factors are relative, it is the weight factor ratios among the three sections that matter.

The Apply smart bulk fitting on molecular weight and mass density button allows you to achieve the best bulk fitting on mass density and molecular weight input curves. If the button is selected, the mass density and molecular weight rows are disabled and the values appear in black.

If the input for either molecular weight or mass density curves is less than 95% on a user defined basis, only the extrapolated tail is adjusted to match the user specified bulk value. If the input is more than or equal to 95% on the user defined basis, the entire curve will be adjusted to match the bulk value specified.

The user input data is the most reliable data available, and hence should not be adjusted to match the bulk value as long as there is enough extrapolated data to adjust.

When only the tail is adjusted, it is ensured that the upper end point is no lower than the linear extrapolation of the last two points. This means that in most cases, the extrapolated portion of the curve is concave, i.e., the curvature is positive. If the bulk value is given such that the extrapolated values are below the linear extrapolation values, the whole curve is adjusted and the following warning message is displayed: "Curve is normalized due to the inconsistency between the supplied curve and bulk data."

If the upper limit value is reached when adjusting the molecular weight or density curve and the specified bulk value is still not matched, no adjustment is made and the following message appears: "No exact match, upper limit reached". For molecular weight, the upper limit value is ten times that of the bulk value. For mass density, the upper limit is three times that of the bulk value.

If a bulk molecular weight or mass density is given without a corresponding input curve, the whole calculated curve will be adjusted.

The 95% input is an artificial dividing line to decide if only the tail is adjusted or the whole curve is adjusted. If the user input curve crosses the dividing line, there is a chance to have a sudden change in the behaviour. If this occurs, you can overcome the problem by manually setting the bulking fitting options without using the smart option. To achieve similar results manually, you can set the Head Adj Wt and Main Adj Wt to zero, set the Main % to the desired tail starting percent, and leave the Tail Adj Wt to its default value of 1.0.

Bulk Properties Definition

These bulk properties are optional except when distillation data is not available (you have selected None as the Data Type). If you do not supply any distillation data, you must supply two of the three initial bulk properties (Molecular Weight, Mass Density or Watson (UOP) K factor) for HYSYS to create a "typical" TBP curve. This TBP curve is generated based on a Whitson molar distribution model.

If you are supplying property curves and you supply a bulk molecular weight, density, or Watson K factor, HYSYS smoothes and adjusts the corresponding curves to match the supplied bulk properties. Note that this procedure is performed whether you supply property curves or they were internally generated by HYSYS.

Assay Definition Group

The Assay Definition group contains only one object involved in the specification of Bulk Properties: the Bulk Properties drop-down. The Bulk Properties drop-down list has two options:

Option	Description
Used	If an Assay Data Type is not selected, the Input Data group displays the Bulk Prop table along with the Molecular Weight of lightest component field. However, if an Assay Data Type is selected, a Bulk Props radio button appears in the Input Data group. When this radio button is active the Bulk Prop table is displayed.
Not Used	No bulk properties are considered in the oil characterization calculations.

Input Data Group

The Input Data group that appears when Used is selected for bulk properties is shown in the figure below:

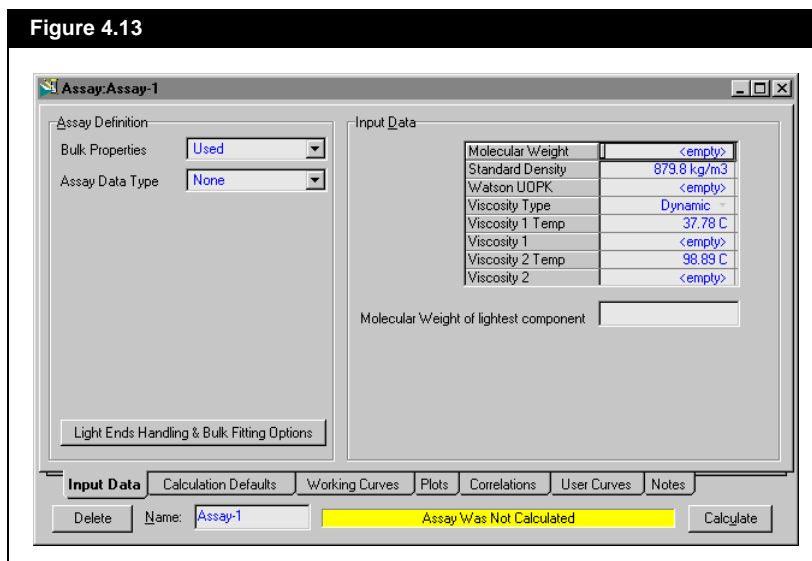

It consists of two objects: the Bulk Properties table and Molecular Weight of lightest component field.

The Molecular Weight of lightest component field is only visible when the Assay Data Type selected is None.

The Watson (UOP) K factor is an approximate index of paraffinicity, with high values corresponding to high degrees of saturation:

$$K = \frac{\sqrt[3]{\text{Mean Avg. BP}}}{sp\ gr\ 60F / 60F}$$

where:

Mean Avg. BP = the mean average boiling point is in degrees Rankine.

The Bulk Properties table has several fields:

Bulk Properties	Description
Molecular Weight	The Molecular Weight must be greater than 16.
Standard Density	The mass density must be between 250 and 2,000 kg/m ³ (note that units can be mass density, API or specific gravity, chosen from the drop-down list).
Watson (UOP) K factor	This factor must be between 8 (highly aromatic or naphthenic) and 15 (highly paraffinic). Only field units are used here.
Bulk Viscosities	The bulk viscosity type and the temperature at two reference points.

Defining Assay Types

Assay Definition Group

To define Assay types, select a type in the Assay Definition group using the drop-down list.

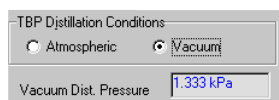
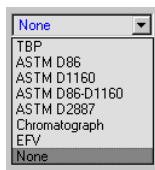

You can specify the ASTM D86/TBP Interconversion Method (API 1974¹, API 1987², API 1994³ or Edmister-Okamoto 1959⁴) on the Calculation Defaults tab. With the ASTM D86 Assay type you can also correct for thermal cracking as well as for elevation.

Assay types that are available are described in the table below:

Assay Type	Description
TBP	True boiling point distillation data at atmospheric pressure. Once you have selected this option, the TBP Distillation Conditions group is displayed. The default distillation conditions are atmospheric, however, you can enable Vacuum Distillation for sub-atmospheric conditions by activating the Vacuum radio button. The default pressure in this case is 10 mmHg (ASTM standard). When you supply sub-atmospheric data, it is automatically corrected from vacuum to atmospheric conditions using procedure 5A1.13 (without <i>K-correction</i>) from the API Data Book.
ASTM D86	Standard ASTM D86 distillation data at atmospheric pressure. Note that you must provide data on a liquid volume basis.
ASTM D1160	ASTM D1160 distillation data. After you have selected this option, the ASTM D1160 Distillation Conditions group is displayed. By default, the Vacuum radio button is selected and the Vacuum Distillation Pressure is set to 10 mmHg (ASTM standard). When ASTM D1160 Vacuum data is supplied, HYSYS will first convert it to TBP vacuum data, and then convert this to TBP data at 760 mmHg using procedure 5A1.13 of the API Data Book. Note that you must provide data on a liquid volume basis.
ASTM D86-D1160	This is the combination of the ASTM D86-D1160 data types. The options for ASTM D86 and ASTM D1160 are similar to the descriptions above. You must provide data on a liquid volume basis.
ASTM D2887	Simulation distillation analysis from chromatographic data, reported only on a weight percent basis at atmospheric pressure. On the Calculation Defaults tab, you have the choice of conversion method (API 1987 ⁵ , API 1994 Indirect ⁶ , API 1994 Direct ⁷).
Chromatograph	A gas chromatograph analysis of a small sample of completely vaporized oil, analyzed for paraffin, aromatic and naphthenic hydrocarbon groups from C ₆ to C ₃₀ . Chromatographic analyses may be entered on a mole, mass, or liquid volume basis. With this option, you enter Light Ends, Bulk and Chromatographic analysis data. (See Chromatographic Assay Input below).
EFV	Equilibrium flash vaporization curve; this involves a series of experiments at constant atmospheric pressure, where the total vapour is in equilibrium with the unvaporized liquid.
None	No distillation data is available; HYSYS generates a TBP curve from bulk property data. With this option, you only enter bulk data.

Input Data Group

The conversion procedure from various assay types to a TBP curve is based on **Figure 3-0.3** of the API Data Book.

The Input Data group displayed when the Distillation radio button is selected depends on the Assay type you have selected in the Assay Definition group.

Distillation Data

Assay Percent [%]	Temperature [C]
0.0000	-9.444
4.500	32.22
9.000	73.89
14.50	115.6
20.00	154.4
30.00	223.9
40.00	273.3
50.00	326.7
60.00	393.3
70.00	473.9
76.00	520.6
80.00	546.1
85.00	565.6
<empty>	<empty>

All input curves except distillation are on midpoint basis. Dependent curves will be shifted to middle.

For Assay Type options TBP, ASTM D86, ASTM D1160, ASTM D2887 and EFV, the procedure for entering boiling temperature information is essentially the same - you are required to enter at least five pairs of Assay Percents and boiling Temperatures. The Distillation input table is exactly the same for each of these options.

You can view and edit the assay boiling Temperature input table by selecting the Distillation radio button and clicking the Edit Assay button.

For the ASTM D86-D1160 characterization procedure, you are required to enter boiling temperature information for both the ASTM D86 and ASTM D1160 data types. This procedure averages the ASTM D86 curve and ASTM D1160 curve in the area where they overlap.

Assay Percent [%]	D86 [F]	D1160 [F]
0.00	750.0	<empty>
5.00	772.0	<empty>
10.00	875.0	620.0
20.00	885.0	<empty>
30.00	895.0	650.0
50.00	<empty>	690.0
70.00	<empty>	740.0
90.00	<empty>	850.0
<empty>	<empty>	<empty>

All input curves except distillation are on basis. Dependent curves will be shifted to

For example, in the combined ASTM D86-D1160 input form shown on the left, the last recorded ASTM D86 assay point is at 30 vol%, and the first reported ASTM D1160 data point is at 10 vol%. Therefore, the resulting TBP curve will represent the average of the two curves between 10 vol% and 30 vol%. Each curve must contain a minimum of 5 data points.

Chromatographic Assay Input

This distillation option allows you to enter a standard laboratory chromatographic analysis directly. The only required input is the assay fraction for each chromatographic hydrocarbon group in the paraffin, aromatic, and naphthenic families. The required minimum of five points can be any combination of points from the three PNA groups. The normal boiling point of each hydrocarbon group is displayed in the PNA tables.

Chromatographic analyses may be entered on either a mole, mass, or liquid volume basis, with the best results obtained when the input fractions are on a mole fraction basis.

A typical C₆₊ liquids chromatographic analysis is shown in the chromatographic input form below.

Figure 4.14

The figure displays three instances of the 'Input Data' form, all set to 'Mole' as the Assay Basis. Each form has radio buttons for 'Bulk Props', 'Paraffinic', 'Aromatic', and 'Naphtenic'. The 'Aromatic' option is selected in all three.

Top Left Form: Shows a list of paraffinic fractions from Hexane (C6) to Heptadecane (C17). The 'Total' value is 0.3900.

Fraction Name	Temp [C]	Fraction
Hexane (C6)	68.9	0.0500
Heptane (C7)	98.3	0.0500
Octane (C8)	125.6	0.0500
Nonane (C9)	150.6	0.0300
Decane (C10)	173.9	0.0400
Undecane (C11)	196.1	0.0400
Dodecane (C12)	215.0	0.0300
Tridecane (C13)	235.0	0.0300
Tetradecane (C14)	252.2	0.0300
Pentadecane (C15)	270.6	0.0200
Hexadecane (C16)	287.8	0.0200
Heptadecane (C17)	302.8	0.0000

Top Right Form: Shows aromatic fractions: Benzene (C6H6), Toluene (C7H8), EBZ, p+m-Xylene (C8H10), o-Xylene (C8H10), and 1,2,4 TMbenzene (C9H12). The 'Total' value is 0.0000.

Fraction Name	Temp [C]	Fraction
Benzene (C6H6)	80.0	0.0000
Toluene (C7H8)	110.6	0.0000
EBZ, p+m-Xylene (C8H10)	136.1	0.0000
o-Xylene (C8H10)	144.4	0.0000
1,2,4 TMbenzene (C9H12)	168.9	0.0000

Bottom Form: Shows naphthenic fractions: Cyclopentane (C5H10), Micyclopentane (C6H12), Cyclohexane (C6H12), and Micyclohexane (C7H14). The 'Total' value is 0.0000.

Fraction Name	Temp [C]	Fraction
Cyclopentane (C5H10)	48.9	0.0000
Micyclopentane (C6H12)	72.2	0.0000
Cyclohexane (C6H12)	81.1	0.0000
Micyclohexane (C7H14)	101.1	0.0000

You may also supply bulk property data (see Bulk Properties in [Section 4.5.1 - Input Data Tab](#) for details).

Note that chromatographic analyses are typically performed after the light ends of the original sample are removed. If you have a Light Ends analysis in this case, refer to [Light Ends Handling & Bulk Fitting](#) for details.

Assay Input - No Distillation Data Available

HYSYS uses the Whitson Molar Distribution model that requires at least two of the three bulk properties (not including bulk viscosities) to produce an average TBP distribution.

When a distillation analysis is not available, HYSYS generates a typical TBP curve based on supplied bulk properties (molecular weight, mass density, and Watson (UOP) *K factor*). You have the option of specifying the molecular weight of the lightest component in the mixture, which may help in generating more accurate TBP curves for heavy petroleum fluids.

Figure 4.15

Input Data	
Molecular Weight	<empty>
Standard Density	879.8 kg/m3
Watson UOPK	<empty>
Viscosity Type	Dynamic
Viscosity 1 Temp	37.78 C
Viscosity 1	<empty>
Viscosity 2 Temp	98.89 C
Viscosity 2	<empty>
Molecular Weight of lightest component	

Although accurate enough for heat balance applications, caution should be exercised when the Whitson option is used to produce hypocomponent for fractionation calculations. This method realistically supplies accuracy sufficient only for preliminary sizing calculations.

For condensate with only bulk data available for the C_{7+} fraction, experience has shown a considerable increase in accuracy by representing the fraction with several hypocomponent as opposed to a single hypothetical component with the bulk properties.

Refer to [Bulk Properties Definition](#) (earlier in this Section) for details on entering bulk property data, particularly in regards to Bulk Viscosities.

General Guidelines

Some general guidelines are provided below:

- There is no limit to the number of assay data points that you may enter for TBP, ASTM D86, ASTM D1160, ASTM D86-D1160 ASTM D2887 or EFV analyses. Data points may be input in any order, as HYSYS automatically sorts your input data.
- HYSYS requires a minimum of 5 data points for all assays. Depending on the shape of the input curve, intermediate values for HYSYS' internal TBP working curve are interpolated using either a third or fourth order LaGrange polynomial fit. The points outside your data are extrapolated using the extrapolation method which you select on Calculation Defaults tab: Least Squares, Lagrange or Probability.
- Each time you change the Basis or Extrapolation method, the Assay needs to be recalculated.
- TBP, EFV, and Chromatographic laboratory assay values may be entered on a liquid volume, mole or weight basis. Liquid volume is the default basis for TBP and EFV input, and mole is the default basis for Chromatographic input. Due to the form of the conversion curves in the API Data Book, you must supply your ASTM D86 and ASTM D1160 distillation data on a liquid volume basis. ASTM D2887 is only reported on a weight percent basis.
- If you are editing an assay, redefining the Basis does not alter your supplied assay values. For example, consider an assay curve with 10, 30, 50, 70 and 90 liquid volume percent points. If you change the Basis to mass percent, the assay percents and temperature are not changed. The temperature you supplied for 10% liquid volume is retained for 10% mass.

HYSYS generates all of its physical and critical properties from an internally generated TBP curve at atmospheric conditions. Regardless of what type of assay data you provide, HYSYS always converts it to an internal TBP curve for the characterization procedure. Note that the internal TBP curve is not stored with the assay.

Light Ends Definition

Light Ends are defined as pure components with low boiling points. Components in the boiling range of C₂ to n-C₅ are most commonly of interest. Generally, it is preferred that the portion of the oil's distillation assay below the boiling point of n-C₅ be replaced with discrete pure components (library or hypothetical). This should always yield more accurate results than using hypocomponent to represent the Light Ends portion.

Assay Definition Group

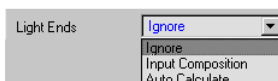

HYSYS provides three options to account for Light Ends, which are as follows:

Option	Description
Ignore	HYSYS characterizes the Light Ends portion of your sample as hypocomponents. This is the least accurate method and as such, is not recommended.
Auto Calculate	Select this when you do not have a separate Light Ends analysis but you want the low boiling portion of your assay represented by pure components. HYSYS only uses the pure components you selected in the fluid package.
Input Composition	Select this when you have a separate Light Ends assay and your petroleum assay was prepared with the light ends in the sample. HYSYS provides a form listing the pure components you selected in the fluid package. Input your data on a non-cumulative basis.

To correctly employ the Auto Calculate or Input Composition options, you should either pick library components, or define hypothetical components to represent the Light Ends before entering the Oil Characterization environment. If you have selected the Auto Calculate method without specifying light ends, HYSYS calculates the oil using only hypocomponent, just as if you had selected Ignore. If you selected Input Composition, there are no light end components for which you can supply compositions. You can go back to the Fluid Package view at any time and define your light components.

The following sections provide a detailed explanation of Light Ends, how the laboratory may account for them, how they are reported and how HYSYS utilizes this information. It is recommended that you read this information to ensure that you are selecting the right options for your assay.

Laboratory Assay Preparation

During TBP and ASTM laboratory distillations, loss of some of the Light Ends components from the sample frequently occurs. To provide increased accuracy, a separate Light Ends assay analyzed using chromatographic techniques may be reported.

Regardless of whether a separate light ends analysis was provided, your overall assay is either Light Ends Included or Light Ends Free. The way in which your sample was analyzed affects both the results and the method you should use to input the information for your characterization.

Light Ends Portion Included in Assay

In this case, your assay data was obtained with the light ends components in the sample; i.e., the assay is for the whole sample. The IBP temperature for your assay is lower than the boiling point of the heaviest pure light end component. This corresponds to an IBP approximately equal to the weighted average boiling point of the first 1% of the overall sample. For example, if the lightest component is propane and it makes up more than 1% of the total sample, the IBP of the assay is approximately -45°F (the normal boiling temperature of propane).

If the Light Ends were included in your overall assay, there are two possibilities:

Option	Description
Light Ends Analysis Supplied	If you know that light ends are included in your assay, select the Input Composition option from the Light Ends group, and enter the composition data directly into the Light Ends composition view.
No Light Ends Analysis Available	If you do not have a laboratory analysis for the light ends portion of your assay, then you should use the Auto Calculate option. HYSYS represents the light ends portion of your assay as discrete pure components, automatically assigning an appropriate assay percentage to each. If you do not do this (you select Ignore), HYSYS represents the Light Ends portion of the assay as petroleum hypocomponent.

Assay is Light Ends Free

Your assay data was analyzed with the Light Ends components removed from the sample, or the assay was already adjusted for the Light Ends components. The IBP temperature for your assay is higher than the boiling point of the heaviest pure light end component - typically your assay is for the C₆₊ fraction only and the IBP temperature is somewhat above 95°F (36°C).

If your distillation data is light-ends free and you have separate light-ends analysis data, you can use HYSYS oil characterization to combine the two. The advantage of doing this is that the bulk properties, if available, will be fitted and matched accurately. To do the combining, you need to input the distillation data and light ends data as usual and then click the **Light Ends Handling & Bulk Fitting Options** button accessible from **Input Data** or **User Curves** tab. In the Light-Ends Handling & Bulk Fitting Options view, uncheck the **Curve Incl L.E.** checkbox for distillation. If you have bulk properties to fit, you need to indicate if the bulk values include light ends by checking or un-checking the **Bulk Value Incl L.E.** checkboxes.

Input Data Group

When you have selected Input Composition as the Light Ends option and you select the Light Ends radio button in the Input Data group, the following view appears.

Figure 4.16

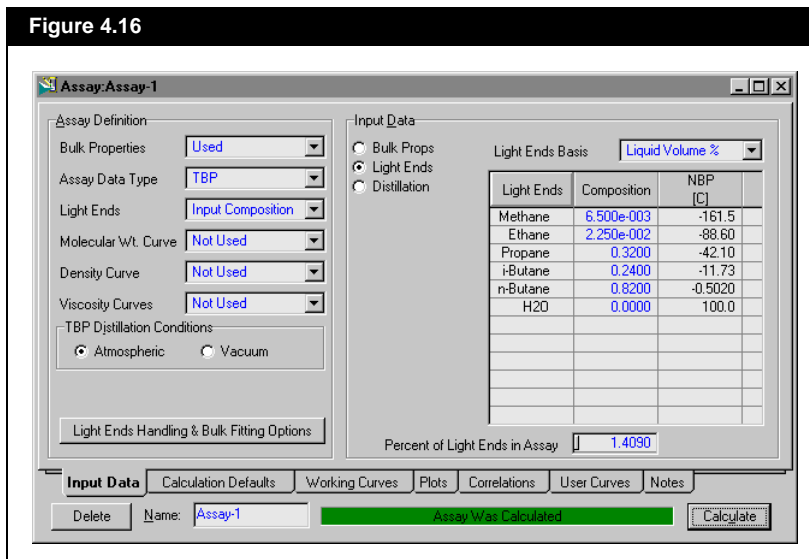

There are three objects associated with the Light Ends Input and are described below:

Object	Description
Light Ends Basis	<p>Allows you to select the basis for the Light Ends analysis on a mole, mass, or liquid volume basis. The way in which you enter the rest of the light ends data depends on whether you select a percent or flow basis:</p> <ul style="list-style-type: none"> • Percent. Enter the percent compositions for the Light Ends on a non-cumulative basis. HYSYS calculates the total Light Ends percentage by summing all of the Light Ends assay data. If the sum of the light ends assay values is equal to 100 (you have submitted normalized data), you must enter the Percent of light ends in the Assay. This value must be on the same basis as the distillation data. Note that if the sum of the light ends is equal to 1.0000, HYSYS assumes that you have entered fractional data (rather than percent), and you are required to enter the Percent of light ends in the Assay. • Flow. Enter the flows for each component, as well as the percent of light ends in the assay.

Object	Description
Light Ends Composition matrix	<p>The matrix consists of the three fields:</p> <ul style="list-style-type: none"> • Light Ends. Displays all pure components or hypotheticals you selected in the associated fluid package. • Composition. The composition value of the associated component is either entered (when Light Ends drop-down is set to Input Composition) or automatically calculated (when the Light Ends drop-down is set to Automatically Calculated) • NBP. The Normal Boiling Point of the associated component or hypothetical.
Percent of lights ends in Assay	<p>The total percentage of light ends in the Assay. If the Light Ends Basis selected is percentage (i.e., LiquidVolume%, Mole% or Mass%), then this is automatically calculated. If the Basis selected is flow based (i.e., Liquid Flow, Mole Flow or Mass Flow), you are required to provide this value.</p>

Auto Calculate Light Ends

Refer to [Appendix B - Petroleum Methods/Correlations](#) for a graphical representation of the Auto Calculate Light Ends removal procedure.

The Auto Calculate extraction procedure internally plots the boiling points of the defined Light Ends components on the TBP working curve and determine their compositions by interpolation. HYSYS adjusts the total Light Ends fraction such that the boiling point of the heaviest Light End is at the centroid volume of the last Light Ends component. The results of this calculation are displayed in Light Ends Composition matrix. However, unlike when setting the Input Composition, the matrix is not editable.

Physical Property Curves Specification

Physical property analyzes are normally reported from the laboratory using one of the following two conventions:

- An Independent assay basis, where a common set of assay fractions is not used for both the distillation curve and physical property curve.
- A Dependent assay basis, where a common set of assay fractions is used for both the distillation curve and the physical property curves.

Note that physical properties are average values for the given range, and hence are midpoint values. Distillation data reports the temperature when the last drop of liquid boils off for a given assay range, and therefore distillation is an endpoint property. Since all dependent input property curves are reported on the same endpoint basis as the distillation curve, they are converted by HYSYS to a midpoint basis. Independent property curves are not altered in any manner as they are already defined on a midpoint basis.

As with distillation curves, there is no limit to the number of data points you provide. The order in which you input the points is not important, as HYSYS sorts the input data. A minimum of five data points is required to define a property curve in HYSYS. It is not necessary that each property curve point have a corresponding distillation value.

Note that entering the 0 vol% point of a dependent curve contributes to defining the shape of the initial portion of the curve, but has no physical meaning since it is a midpoint property curve.

If a bulk molecular weight or mass density is going to be supplied, then the corresponding Molecular Weight or Density working curve generated from your input is smoothed to ensure a match. If you do not enter bulk properties, then they are calculated from the unsmoothed working curves.

Assay Definition Group

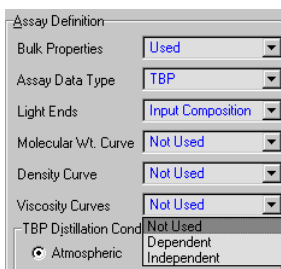

Each property curve type (i.e., Molecular Wt., Density and Viscosity) has its own drop-down list in the Assay Definition group. Each drop-down list contains the same three options and are described below:

Option	Description
Not Used	No property data is considered in the assay calculation.
Dependent	A common set of assay fractions is used for both the distillation curve and the physical property curves.
Independent	A common set of assay fractions is <i>not</i> used for both the distillation curve and physical property curve.

Input Data Group

Defining Molecular Weight and Density property curves as either Independent or Dependent adds the corresponding radio button to the Input Data group. However, defining a Viscosity property curve as Independent or Dependent, HYSYS accepts viscosities for assay values at two specified temperatures, with the default temperatures being 100 and 210°F. Activating the Molecular Wt., Density, Viscosity1 or Viscosity2 radio buttons brings up the objects associated with the specification of the respective property curve.

To enter the property curve data, simply select the radio button for the property curve you want to input and click the Edit Assay button.

Molecular Wt. Curve

An example of a Molecular Weight assay is shown below:

Figure 4.17

Assay Percent	Mole Wt.
0.0000	68.00
4.5000	90.00
9.0000	117.0
14.50	135.0
20.00	150.0
30.00	182.0
40.00	225.0
50.00	282.0
60.00	350.0
70.00	456.0
80.00	585.0
90.00	713.0

Note that with Dependent Curves, making a change to an Assay Percent value automatically changes this value in all other Dependent curves (including the Boiling Point curve).

The assay data is entered into the Assay Input Table view which is opened when the Edit Assay button is selected. The form of this view is the same regardless of whether you have specified Independent or Dependent data. However, if you specified Dependent data, the Assay Percents that you defined for the distillation data are automatically entered in the table.

Depending on the shape of the curve, intermediate values for HYSYS' internal working curve are interpolated using either a third or fourth order Lagrange polynomial fit of your input curve, while points outside your data are extrapolated. You can select the extrapolation method for the fit of your input curve on the Calculation Defaults tab: Least Squares, Lagrange or Probability.

Density Curve

An example of a Density assay is shown below:

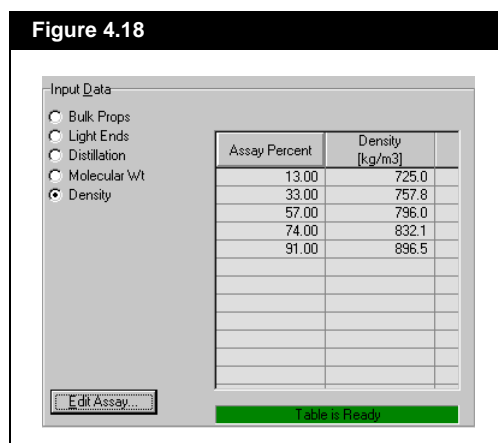

The assay data is entered into the Assay Input Table view which is opened when the Edit Assay button is selected. The form of this view is the same regardless of whether you have specified Independent or Dependent data. However, if you specified Dependent data, the Assay Percents that you defined for the distillation data are automatically entered in the table.

Depending on the shape of the curve, intermediate values for HYSYS' internal working curve are interpolated using either a third or fourth order Lagrange polynomial fit of your input curve, while points outside your data are extrapolated. You may select the extrapolation method for the fit of your input curve on the Calculation Defaults tab: Least Squares, Lagrange (default) or Probability.

Viscosity Curves

HYSYS accepts viscosities for assay data at two specified temperatures and therefore provides two radio buttons, Viscosity1 and Viscosity2, in the Input Data group.

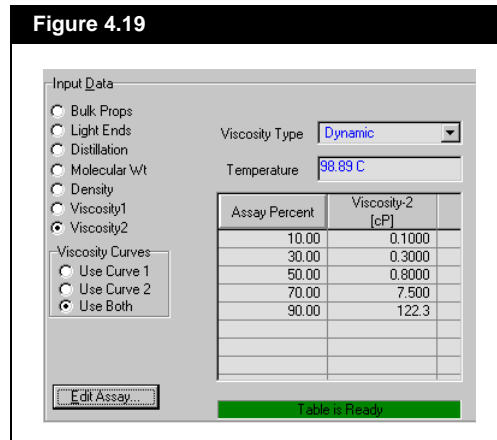

You can input data for one or both of the viscosity curves. Each radio button brings up identical sets of objects, specific to assay data at the designated temperature. Temperatures are entered in the Temperature field with default values being 100 and 210°F. This implies that you have determined the viscosity at 100 or 210°F for each of your assay portions (10%, 20%, etc.).

In the Viscosity Curves group box, you can specify which curve (or both) you want to use by selecting the appropriate radio button.

The Assay Input Table view, which is opened when the Edit Assay button is selected, is filled in with the assay data. The form of this view is the same regardless of whether you have specified Independent or Dependent data. However, if you specified Dependent data, the Assay Percents that you defined for the distillation data are automatically entered in the table.

You may also define the viscosity unit type. The Units Type can be one of the following:

Unit Type	Description
Dynamic	Conventional viscosity units (e.g., - cP)
Kinematic	Ratio of a fluid's viscosity to its density (e.g.,- stoke, m ² /s)

Depending on the shape of the curve, intermediate values for HYSYS' internal working curve are interpolated using either a third or fourth order Lagrange polynomial fit of your input curve, while points outside your data are extrapolated. You may select the extrapolation method for the fit of your input curve on the Calculation Defaults tab: Least Squares, Lagrange or Probability.

The defaults for a new assay may be modified by clicking the **Oil Input Preferences...** button on the **Assay** tab of the Oil Characterization view. The same view may also be accessed from the Simulation environment by the following sequence:

1. Select **Tools-Preferences** command from the menu bar.
2. On the Session Preferences view, go to the **Oil Input** tab.
3. Select the **Assay Options** page.

4.5.2 Calculation Defaults Tab

The Calculation Defaults tab is shown below:

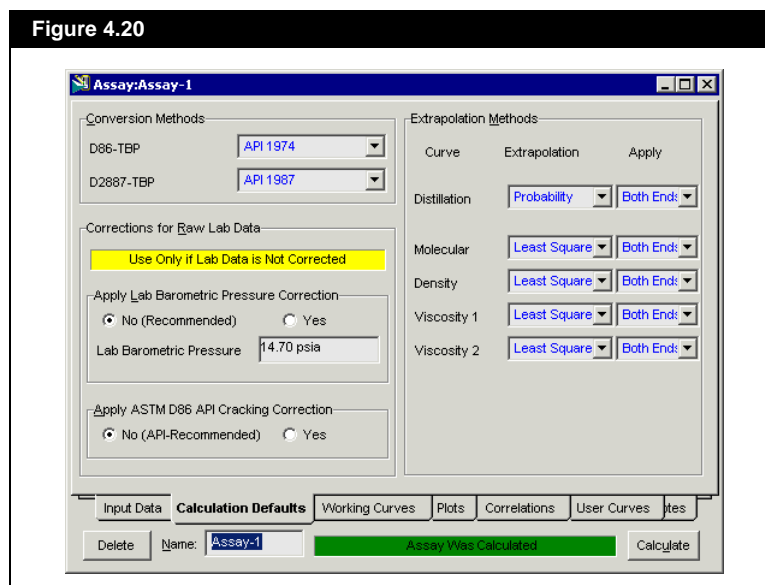

Note that the internal TBP curve is not stored with the assay. The Calculation Defaults tab contains three main groups:

- Conversion Methods
- Corrections for Raw Lab Data
- Extrapolation Methods

Conversion Methods Group

HYSYS generates all of its physical and critical properties from an internally generated TBP curve at atmospheric conditions. Regardless of what type of assay data you provide, HYSYS always converts it to an internal TBP curve for the characterization procedure. For ASTM D86 and ASTM D2887 assays types, you may specify the inter-conversion or conversion methods used in the Conversion Methods group. The group consists of the following two drop-down lists:

Field	Description
D86-TBP (Interconversion)	There are four interconversion methods available: <ul style="list-style-type: none"> • API 1974¹ • API 1987² • API 1994³ • Edminster Okamoto 1959⁴
D2887-TBP (Interconversion)	There are three interconversion methods available: <ul style="list-style-type: none"> • API 1987⁵ • API 1994 Indirect⁶ • API 1994 Direct⁷

Corrections for Raw Lab Data Group

In this group, two correction methods are available for previously uncorrected laboratory data:

Correction	Description
Apply Lab Barometric Pressure Correction	ASTM D86 data that is generated above sea level conditions must be corrected for barometric pressure. If this is not done by the laboratory, select the Yes radio button from the subgroup and HYSYS performs the necessary corrections. Enter the ambient laboratory barometric pressure in the Lab Barometric Pressure field and HYSYS corrects your ASTM distillation data to 1atm before applying the API Data Book conversions for ASTM D86 to TBP distillation.
Apply ASTM D86 API Cracking Correction	Note that API no longer recommends using this correction: The ASTM cracking correction is designed to correct for the effects of thermal cracking that occur during the laboratory distillation. If this is not done by the laboratory, select the Yes radio button, and HYSYS performs the necessary corrections. This correction is only applied to ASTM D86 temperatures greater than 485°F (250°C). Note that the API cracking correction should not be applied to ASTM D86 distillations that extend beyond 900°F (500°C), due to the exponential nature of the correction.

Extrapolation Methods Group

HYSYS allows you to choose the extrapolation method used for the different Assays (i.e., Distillation and the Molecular Weight, Density and Viscosity property curves). There are three methods available:

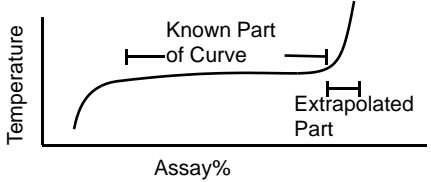
Extrapolation Method	Uses
Lagrange	For assays representing cuts (i.e., naphtha) or assays for properties other than Boiling Temperature.
Least Squares	The Least Squares method is a lower order Lagrange method. For this method, the last five input points are used to fit a second order polynomial. If the curvature is negative, a straight line is fit.
Probability	Use the Probability extrapolation method in cases when your Boiling Temperature assay represents a full range crude and the data is relatively flat. For instance, the data in the distillation range of your assay (i.e., 10% to 70%) may be relatively constant. Instead of linearly extending the curve to the IBP and FBP, the Probability method only considers the steep rise from the FBP. 

This group also allows you to specify which end of the curve to apply the extrapolation method. There are three choices available:

- Upper end
- Lower end
- Both ends

4.5.3 Working Curves Tab

The third tab of the Assay view is the **Working Curves** tab. After the Assay is calculated, you can view the Assay Working Curves:

Figure 4.21

Point #	Moles	Cum. Moles	NBP [C]	Mole Wt	Mass Density [kg/m3]	Viscosity 1 [cP]	Viscosity 2 [cP]
0	0.00000	0.00000	-0.5020	56.87	584.6	0.137	0.081
1	0.01000	0.01000	9.315	59.69	691.8	0.251	0.132
2	0.01000	0.02000	18.26	62.72	699.2	0.267	0.142
3	0.01000	0.03000	27.59	65.90	706.5	0.285	0.153
4	0.01000	0.04000	36.93	69.52	713.8	0.294	0.162
5	0.01000	0.05000	46.24	73.42	720.9	0.299	0.168
6	0.01000	0.06000	55.45	77.35	727.7	0.288	0.167
7	0.01000	0.07000	64.52	81.30	734.4	0.306	0.185
8	0.01000	0.08000	73.31	85.10	740.7	0.325	0.196
9	0.01000	0.09000	80.84	87.93	746.0	0.343	0.205
10	0.01000	0.10000	86.32	90.30	749.9	0.358	0.213
11	0.02500	0.12500	101.6	98.71	760.3	0.405	0.237
12	0.02500	0.15000	119.8	108.1	772.4	0.473	0.271
13	0.02500	0.17500	137.2	117.3	783.6	0.552	0.308
14	0.02500	0.20000	154.5	127.1	794.5	0.644	0.350

Recall that the working curves are interpolated using either a third or fourth order Lagrange polynomial fit of your input curve, while the method used to extrapolate points outside your data depends on the type of curve (Mass Density, Viscosity, Molecular Weight). You select the method for the fit of your input curve: Least Squares, Lagrange or Probability.

HYSYS always uses 50 points in the calculation of the working curves, but the molar distribution varies depending on the data you provide. In cases where there is a region with a steep gradient, HYSYS moves more points to that region, but still uses 50 points.

4.5.4 Plots Tab

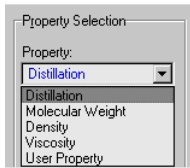

The **User Property** option is only available if a User Property is created and a User Curve is defined in the Assay.

Following the Working Curves tab is the Plots tab, on which you can view any of the input data curves in a graphical format.

The Property drop-down list, shown above, displays the options available for the y-axis of the plot. The Distillation option shows the boiling temperature input according to the Assay Type chosen (i.e., TBP, ASTM D86, etc.). The x-axis displays the Assay% on a basis consistent with the format of your input.

An example of a distillation boiling point curve is shown in the figure below. All of the entered data point pairs and the interpolated values are drawn on the plot.

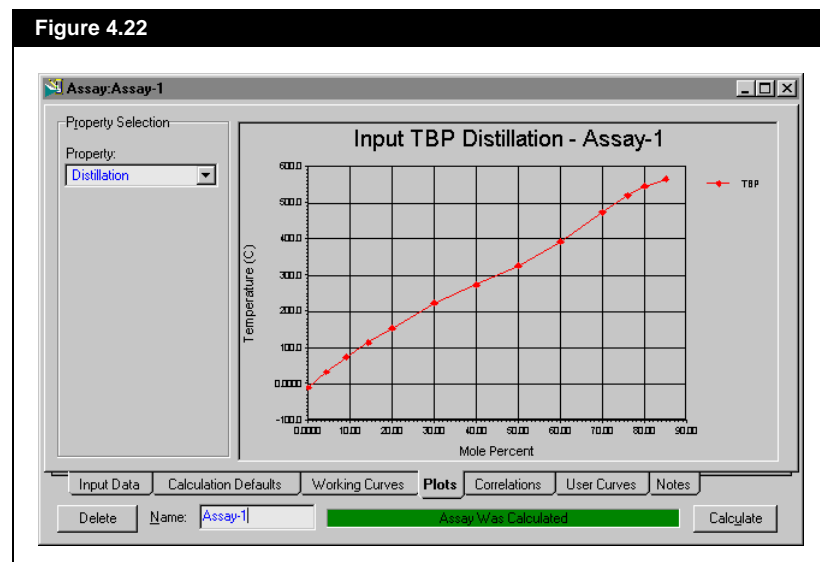

For details on the various Graph Control options, refer to [Section 10.4 - Graph Control](#) of the User Guide.

To make changes to the appearance of the plot, object inspect the plot area. From the menu that appears, select Graph Control.

4.5.5 Correlations Tab

The Correlations tab of the Assay property view is shown below:

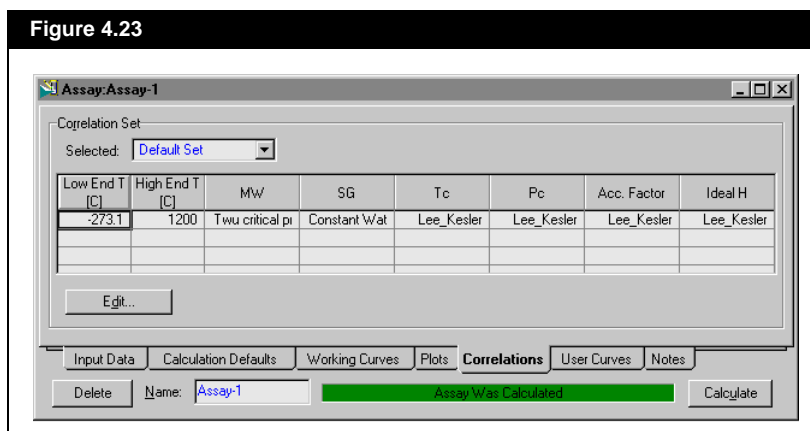

The correlations tab consists of the following objects:

You can define new correlations sets via the Correlation tab, accessible from the main Oil Characterization view. See [Section 4.8.1 - Correlation Tab](#).

You can change only the name of the default set. If you want to change any correlations, you must create a new correlation set.

Object	Description
Selected Correlation Set	By default, this is Default Set (if you have changed the name of the default set, that name is displayed). You can select another correlation set from the Selected drop-down list, but first you must define one on the Correlation tab of the Oil Characterization property view.
Low and High End Temperature	This is the range for which the Correlations are applied. If you split the range, then more than one temperature range is displayed. Note that you can edit the temperature of defined splits for custom Correlation Sets on this tab.
MW	The MW correlation is displayed. You cannot change the correlation in this view; this can be done from the Correlation tab accessible from the main Oil Characterization view or by clicking the Edit button.
SG	The specific gravity (density) correlation is displayed. You cannot change the correlation in this view; this can be done from the Correlation tab accessible from the main Oil Characterization view or by clicking the Edit button.
Tc, Pc, Acc. Factor, Ideal H	The critical temperature, critical pressure, acentricity and Ideal Enthalpy correlations are displayed. You cannot change correlations on this tab; this can be done in the Correlation view accessible from the main Oil Characterization view. To edit the Selected Correlation Set from this tab, click the Edit button. This takes you to the Correlation view.

Although a Correlation set contains methods for all properties, the Correlation tab, as seen on the Assay and Blend views, displays only the properties appropriate to that step in the Characterization process.

Only the molecular weight and specific gravity correlations are required in the calculation of the working curves. Note that the critical pressure, critical temperature, acentricity, and ideal enthalpy correlations are also displayed on the Assay property view, as these are applicable only in the calculation of the hypocomponent properties.

If you supply molecular weight or density curves, then their respective correlations are not required. Note that you do not have a choice of correlations for calculating the viscosity curves.

4.5.6 User Curves Tab

See [Light Ends Handling & Bulk Fitting](#) for details on the Light Ends Handling & Bulk Fitting Options button.

The User Curves tab of the Assay property view is shown below:

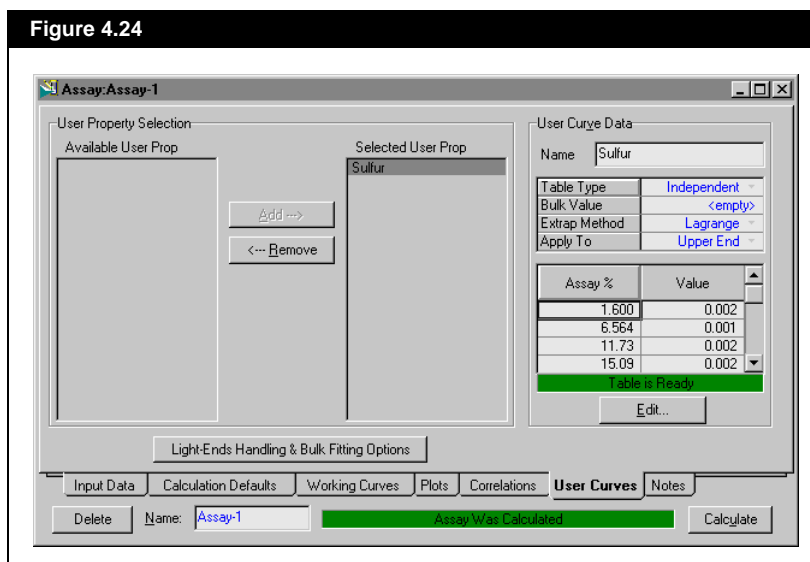

There are two elements to a User Curve:

- The definition of how the property value is calculated for a stream (mixing rule).
- The assay/property value information that is supplied for a given assay.

The property definition (see [Section 4.7 - User Property](#) for details) is common to all assays.

The available and selected User Properties are displayed in the left portion of the view. Note that User Properties are defined on the User Property tab of the Oil Characterization view.

After a User Property is defined, you can add it to the Assay by highlighting it and selecting the Add button. To remove a User Property from the current Assay, highlight it and select the Remove button. Double-clicking on a User Property name in the selection list opens the user property view as described in [Section 4.7.2 - User Property View](#).

After adding a User Property, you can edit the User Curve Data:

User Curve Data	Description
Table Type	This is either Dependent or Independent. If you select Dependent, the Assay Percents are automatically set to the values you specified for the Boiling Temperature assay (Input Data tab). Note that if the table type is Dependent and you change the assay percents on this tab, this also changes the assay percents in the Distillation boiling temperature matrix and for any other dependent curve.
Bulk Value	Specify a Bulk Value. If you do not want to supply a bulk value for the user property, ensure that this cell reads <empty> by placing the cursor in that cell and pressing the DELETE key.
Extrapolation Method	This field allows you to choose the extrapolation method used for the selected user property in the current assay. The available choices are: <ul style="list-style-type: none"> • Least Squares • Lagrange • Probability
Apply To	This field allows you to choose which end of the curve to apply the extrapolation method to. There are three choices available: <ul style="list-style-type: none"> • Upper end • Lower end • Both ends
User Property Table	Provide the Assay percents and User Property Values in this table. At least five pairs of data are required.

4.5.7 Notes Tab

HYSYS provides a tab where you can enter a description of the Assay for your own future reference. This can also be accessed through the notes manager.

4.6 Hypocomponent Generation

Note that for a highlighted Blend, you can edit the name and provide a description in the Blend Information group.

The Cut/Blend tab of the Oil Characterization view is shown below:

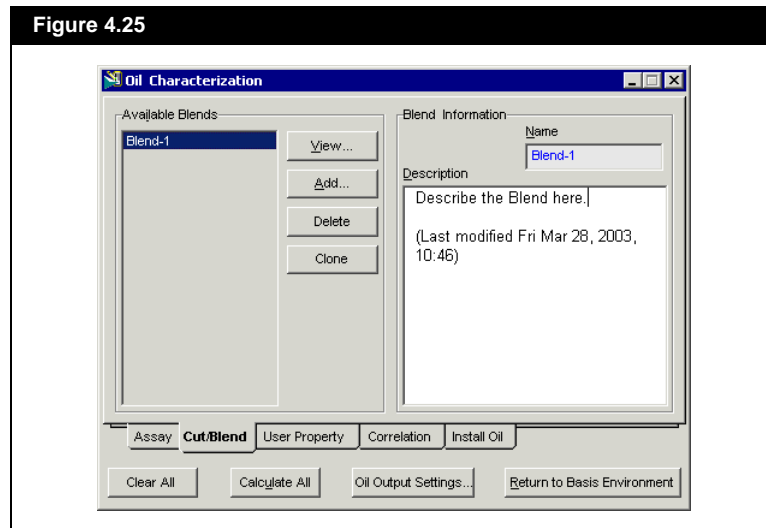

The Available Blends are listed in the left portion of the view. The following Blend manipulation buttons are available:

Button	Description
View	Edit the currently highlighted Blend.
Add	Create a new Blend.
Delete	Erase the currently highlighted Blend. HYSYS does not prompt for confirmation when deleting a Blend, so be careful when you are using this command.
Clone	Create a new Blend with the same properties as the currently highlighted Blend. HYSYS immediately opens a new Blend view.

As described in the Oil Characterization View section:

- The **Clear All** button is used to delete all Oil Characterization information.
- The **Calculate All** button re-calculates all Assay and Blend information.
- The **Oil Output Settings...** button allows you to change IBP, FBP, ASTM D86, and ASTM D2887 interconversion methods for output related calculations.

In the following sections, each tab of the Blend property view (accessed through the View or Add buttons) is described.

4.6.1 Data Tab

All Boiling Point information supplied in an assay is converted to TBP format.

The Cut/Blend characterization in HYSYS splits internal working curves for one or more assays into hypocomponents. Once your assay information is entered through the Assay view, you must Add a Blend and transfer at least one Assay to the Oil Flow Information table to split the TBP working curve(s) into discrete hypocomponent. The first tab of the Blend view is shown below:

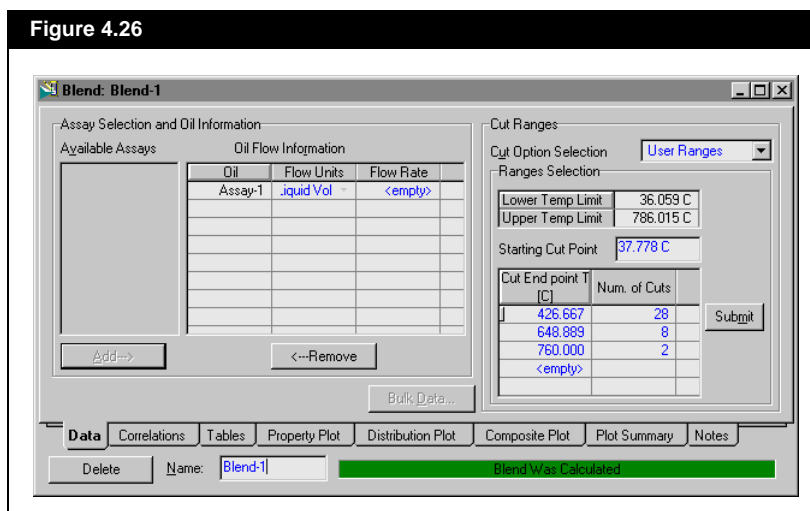

To view an Assay, double-click on the Assay name, either in the Available Assays list, or in the Oil column of the Oil Flow Information table.

There is no limitation to the number of assays that can be included in a single blend or to the number of blends that can contain a given assay. Each blend is treated as a single oil and does not share hypocomponent with other blends or oils.

Note also that you are allowed to define a flowsheet stream for each constituent assay in a blend.

Assay Selection

A list of the available Assays is shown in the left portion of the view. You can choose an assay by highlighting it and clicking the Add button. It is removed from the Available Assays list and added to the Oil Flow Information table, which displays the following information:

Oil Flow Information	Description
Oil	The name of the Assay is displayed in this column.
Flow Units	You can select the Flow Basis (Mole, Mass or Liquid Volume) here. Note that if you have several Assays, it is not necessary that they have the same Flow Basis.
Flow Rate	Enter the flow rate; you can use any units (with the same basis); they are converted to the default.

Note that you can remove an Assay from the Oil Flow Information table by highlighting it and selecting the Remove button.

Bulk Data

The Bulk Data button becomes available when more than one assay is present in the Oil Flow Information table.

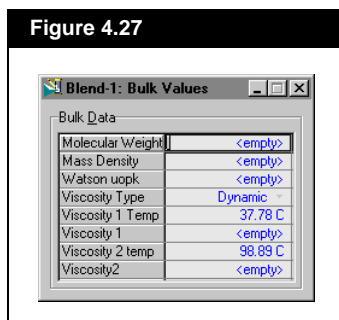

HYSYS allows you to provide the following bulk data for a blend on the Bulk Values view:

- Molecular Weight
- Mass Density
- Watson (UOP) K
- Viscosities at 2 temperatures

The Bulk Data feature is particularly useful for supplying the bulk viscosities of the blend, if they are known.

Cut Ranges

When you re-cut an oil, HYSYS will automatically update the associated flowsheet streams with the new hypocomponents when you leave the Basis Environment.

You have three choices for the Cut Option Selection:

Cut Options	Description
Auto Cut	HYSYS cuts the assay based on internal values.
User Ranges	You specify the boiling point ranges and number of cuts per range.
User Points	You specify only how many hypocomponent you require. HYSYS proportions the cuts according to an internal weighting scheme.

These methods are described in detail later in this section.

You can specify as many components as you want, within the limitations of the available memory. Whether specified or calculated internally, each cut point is integrated to determine the average (centroid) boiling point. The centroid is always determined using HYSYS' internally generated TBP curve on a weight basis.

Although the external procedure for blending assays is almost identical with that for cutting a single assay, HYSYS' internal procedure is somewhat different. After HYSYS has converted each assay to a TBP vs. weight percent curve, all of the individual curves are combined to produce a single composite TBP curve. This composite curve is then used as if it were associated with a single assay; hypocomponents are generated based on your instructions.

These hypocomponents are now common to the blended oil and all the constituent oils. For each of the constituent oils, HYSYS back calculates the compositions that correspond to these hypocomponents.

Caution should be exercised when blending some combinations of analyzes. An inherent advantage, as well as limitation, of blending is that all constituent oils share a common set of hypocomponent and therefore physical property characteristics. Any analyzes that have large overlapping TBP curves and very different physical property curves should not be blended (for example, hydrocracker recycles and feedstocks have similar TBPs but very different gravity curves). The physical properties of components for overlapping areas represent an average that may not represent either of the constituent assays.

HYSYS allows you to assign the overall blend composition and/or individual assay compositions to streams via the Install Oil tab ([Section 4.8.3 - Install Oil Tab](#)).

This procedure is recommended whenever recombining product oils or fractions to produce a single inlet stream, for example in generating a feed for an FCCU main fractionator from analyzes of the product streams. The major advantage to blending is that fewer hypocomponents are used to represent a given feed because duplicate components for overlapping TBP curves are eliminated.

A second advantage is that the composite TBP curve tends to smooth the end portions of the individual assay curves where they may not be as accurate as the middle portions of the curves.

Recommended Boiling Point Widths

The following table is a guideline for determining the number of splits for each boiling point range. These are based upon typical refinery operations and should provide sufficient accuracy for most applications. You may want to increase the number of splits for ranges where more detailed fractionation is required.

Cutpoint Range	Boiling Point Width	Cuts/100°F
IBP to 800°F (425°C)	25°F (15°C) per cut	4
800°F to 1200°F (650°C)	50°F (30°C) per cut	2
1200°F to 1650°F (900°C)	100°F (55°C) per cut	1

Regardless of your input data, it is recommended that you limit your upper boiling range to 1650°F (900°C). All of the critical property correlations are based on specific gravity and normal boiling points and thus, NBPs above this limit may produce erroneous results. The critical pressure correlations control this limit. There is no loss in accuracy by lumping the heavy ends because incremental changes in solubility of lighter components are negligible and this range is generally not be fractionated.

Auto Cut

If you select the AutoCut option, HYSYS performs the cutting automatically. HYSYS uses the boiling point width guidelines, as shown previously:

Range	Cuts
100 - 800°F	28
800 - 1200°F	8
1200 - 1600°F	4

User Points

If you select User Points from the Cut Option Selection drop-down list, HYSYS performs the cutting process depending on the number of cuts you specify. Enter the total number of cuts you want to use for the oil in the appropriate field. All splits are based upon TBP temperature, independent of the source or type of assay data. HYSYS proportions the cuts according to the following table:

Cutpoint Range	Internal Weighting
IBP - 800°F (425°C)	4 per 100°F
800°F - 1200°F (650°C)	2 per 100°F
1200°F to FBP	1 per 100°F

The internal weighting produces more hypocomponents per 100°F range at the lower boiling point end of the assay. For example, given a TBP temperature range of 100°F to 1400°F and 38 components requested, HYSYS produces 28 components for the first range, eight components for the second range and two components for the last range:

$$(800 - 100) / 100 * 4 = 28$$

$$(1200 - 800) / 100 * 2 = 8$$

$$(1400 - 1200) / 100 * 1 = 2$$

User Ranges

If you want to define cutpoint ranges and specify the number of hypocomponent in each range, select User Ranges and HYSYS displays the Ranges Selection information as shown in the figure below.

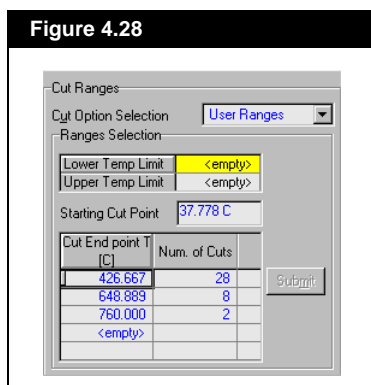

The IBP and FBP are shown above and these values correspond to the initial boiling point and the final boiling point of HYSYS' internal TBP working curve. At this point all light ends are removed (if requested) and the IBP presented is on a light ends free basis. Refer to the Boiling Ranges [Section 4.4 - Oil Characterization View](#) for definitions of the IBP and FBP.

Note that the IBP and FBP of the internal TBP curve used for the column operation's cutpoint specifications and the boiling point tables are determined in this manner. If the first or last hypocomponent has a volume fraction larger than that defined by the endpoints for the IBP or FBP respectively, the TBP curve is extrapolated using a spline fit.

You may supply the Initial Cut Point; however, if this field is left blank, HYSYS uses the IBP. HYSYS combines the material boiling between the IBP and the initial cutpoint temperature with the material from the first cut to produce the first component. This component has an NBP centroid approximately half way between these boundaries.

The next parameters that you must supply are the upper cutpoint temperature and the number of cuts for the first cutpoint range. As shown in [Figure 4.28](#), the upper cutpoint temperature for the first range also corresponds to the lower boiling point of the second cutpoint range, so it does not have to be re-entered. After the first cut range is defined, only the upper cutpoint temperature and the number of cuts need to be supplied for the remaining ranges. If the final cutpoint temperature is not equal to or greater than the FBP, HYSYS combines the material between the FBP and the last cut temperature with the material in the last component.

For example, assume that the IBP and FBP are 40 and 1050°F respectively, the initial cut temperature is 100, the upper limit for the first cut is 500 degrees, and the number of cuts in the first range is eight.

Since the boiling width for each component in the first cut range is 50°F (i.e., $[500-100]/8$), the first component's NBP is at the centroid volume of the 40 to 150 cut, in this case approximately 95°F. The remaining components have NBP values of approximately 175, 225, 275, 325, 375, 425 and 475°F. The upper temperature for the second range is 1,000 and the number of cuts is equal to 5. Since the FBP is 1050, the material in the boiling range from 1,000 to 1,050 is included with the last component.

4.6.2 Correlations Tab

The Correlations tab of the Blend property view is shown in the figure below:

Figure 4.29

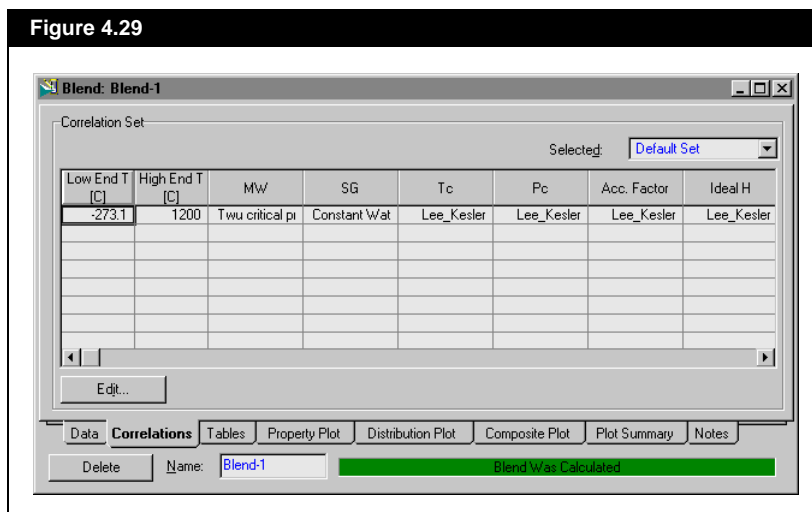

As in the Assay Oil characterization, you can only change the name of the default set. If you want to change any correlations, you must create a new correlation set.

The Correlations tab consists of the following objects:

Object	Description
Selected Correlation Set	By default, this is Default Set (if you have changed the name of the default set, that name is displayed). You can select another correlation set from the Selected drop-down list, but first you must define one on the Correlation tab of the Oil Characterization property view.
Low and High End Temperature	This is the range for which the Correlations are applied. If you split the range, then more than one temperature range is displayed. Note that you can edit the temperature of defined splits for custom Correlation Sets on this tab.
MW	The MW correlation is displayed. You cannot change the correlation in this view; this can be done from the Correlation tab accessible from the main Oil Characterization view or by clicking the Edit button.
SG	The specific gravity (density) correlation is displayed. You cannot change the correlation in this view; this can be done from the Correlation tab accessible from the main Oil Characterization view or by clicking the Edit button.
Tc, Pc, Acc. Factor, Ideal H	The critical temperature, critical pressure, acentricity and Ideal Enthalpy correlations are displayed. You cannot change correlations on this tab; this can be done in the Correlation view accessible from the main Oil Characterization view. To edit the Selected Correlation Set from this tab, click the Edit button. This takes you to the Correlation view.

You can define new correlations sets via the Correlation tab, accessible from the main Oil Characterization view. See [Section 4.8.1 - Correlation Tab](#).

You can change only the name of the default set. If you want to change any correlations, you must create a new correlation set.

The critical pressure, critical temperature, acentricity and ideal enthalpy correlations are required in the Blend calculation (or more specifically, in the calculation of hypocomponent properties). In the calculation of hypocomponent properties, the molecular weight and specific gravity (and viscosity) are estimated from their respective working curves.

4.6.3 Tables Tab

After calculating a Blend, you can examine various property and flow summaries for the generated hypocomponent that represent a calculated oil.

Figure 4.30

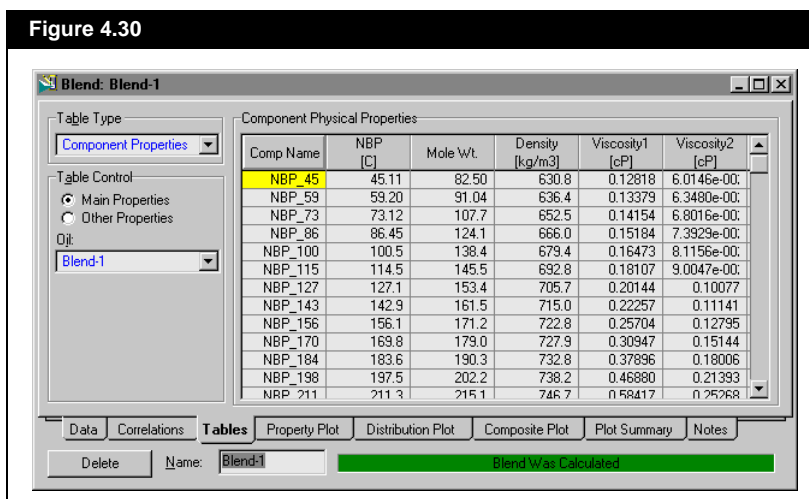

From the Table Type drop-down list, you can select any one of the following:

Table Type	Description
Component Properties	<p>With this Table Type selection, you can select one of the two radio buttons in the Table Control group:</p> <ul style="list-style-type: none"> • Main Properties. Provides the normal boiling point, molecular weight, density and viscosity information for each individual component in the oil. • Other Properties. Provides the critical temperature, critical pressure, acentric factor and Watson K factor for each individual hypocomponent.
Component Breakdown	Provides individual liquid volume%, cumulative liquid volume%, volume flows, mass flows and mole flows, for the input light ends and each hypocomponent in the oil.

Table Type	Description
Molar Compositions	Provides the molar fraction of each light end component and each hypocomponent in the oil.
Oil Properties	<p>For this selection, you can select the Basis (liquid volume, molar or mass) in the Table Control group box. There are also three radio buttons, each producing a different table:</p> <ul style="list-style-type: none"> • Distillation. Provides TBP, ASTM D86, D86 Crack Reduced, ASTM D1160 (Vac), ASTM D1160 (Atm), and ASTM D2887 temperature ranges for the oil. • Other Properties. Provides critical temperature, critical pressure, acentric factor, molecular weight, density and viscosity ranges for the oil. • User Properties. Provides all user property ranges for the oil.
Oil Distributions	<p>Provides tabular information on how your assay would be roughly distributed in a fractionation column. Examine the End Temperatures of the various ranges as well as the Cut Distributions. You can select the basis for the Cut Distribution Fractions (Liquid Volume, Molar, Mass) in the Table Control group. The radio buttons provide the option of standard fractionation cuts or user defined cuts:</p> <ul style="list-style-type: none"> • Straight Run. Lists crude column cuts: Off gas, LSR Naphtha, Naphtha, Kerosene, Light Diesel, Heavy Diesel, Atmos Gas Oil and Residue. • Cycle Oil. Lists Cat Cracker cycle oils: Off Gas, LC Naphtha, HC Naphtha, LCGO, ICGO, HCGO, Residue 1 and Residue 2. • Vacuum Oil. Lists vacuum column cuts: Off Gas, LVGO, HVGO and 5 VAC Residue ranges. • User Custom. Allows for the definition of customized temperature ranges. If changes are made to the information in any of the standard fractionation cuts, the radio button will automatically switch to User Custom.

4.6.4 Property Plot Tab

HYSYS can plot various properties versus liquid volume, mole or mass percent distilled. The x-axis choice is made from the Basis drop-down list. Any of the following options may be plotted on the y-axis by making a selection from the Property drop-down list:

- Distillation. A table appears in which you can select which boiling point curves to examine. Activate the checkbox of each curve you want displayed. The options include: TBP, ASTM D86, D86(Crack Reduced), ASTM D1160(Vac), ASTM D1160(Atm) and ASTM D2887.
- Molecular Weight
- Density
- Viscosities at 100 and 210°F (or the input temperature)
- Critical Temperature

- Critical Pressure
- Acentric Factor
- User Property. A table appears to allow you the choice of which user property to plot.

Refer to the [Section 4.6.7 - Plot Summary Tab](#) section for information concerning the Plot Summary tab.

Click the Clone and shelf this plot button to store the current plot. HYSYS automatically names the plot with the following format: 'the name of the active blend' - 'number of plots created'. For instance, the first plot created for Blend-1 would be named Blend-1-0, and any subsequent plots would have the number after the dash incrementally increased.

Plot labels can not be modified within the Property Plot tab Blend view.

To edit plot labels, you must clone the plot using the Clone and shelf this plot button. The BlendPlot appears and is stored in the Plot Summary tab.

An example of a TBP curve on a liquid volume basis for an oil is shown below.

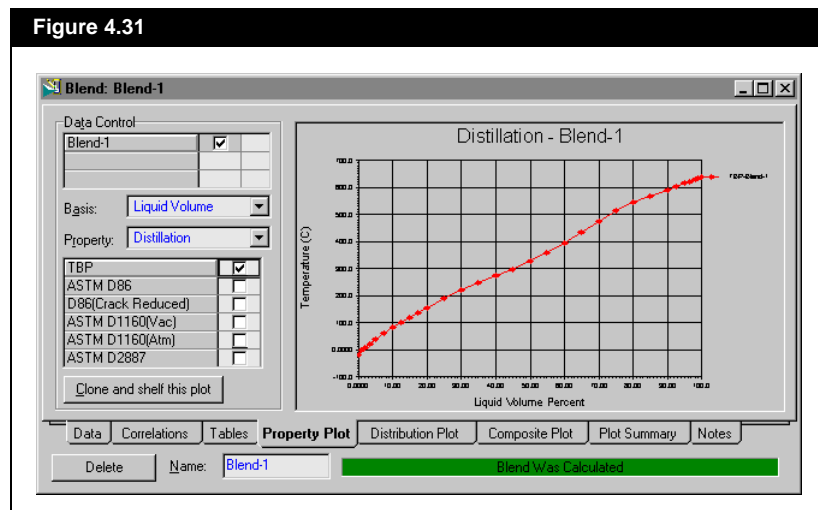

4.6.5 Distribution Plot Tab

HYSYS can also plot a distribution bar chart so you can study how your assay would be roughly distributed in a fractionation column. Straight Run, Cycle Oil, Vacuum Oil and User Custom TBP cutpoints are available distribution options, as shown by the radio buttons in the Cut Input Information group. You can choose the Basis for the Cut Distribution Fractions (Liquid Volume, Molar, Mass) in the Plot Control group.

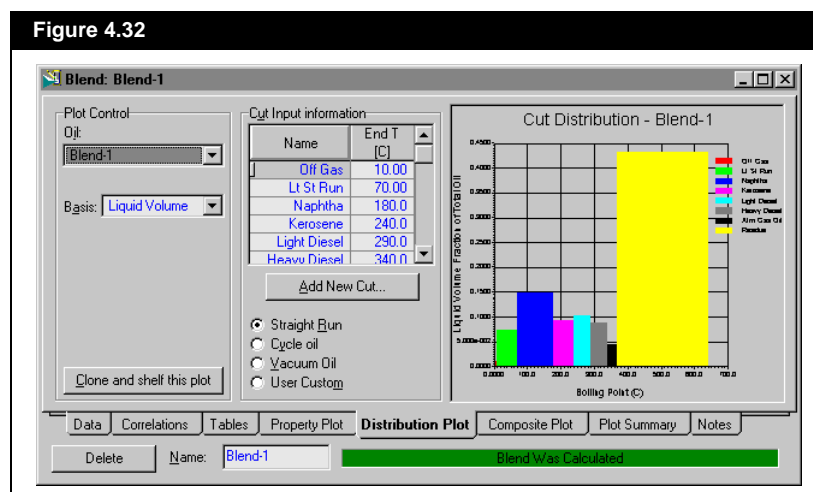

Click the Clone and shelf this plot button to store the current plot. HYSYS automatically names the plot with the following format: 'the name of the active blend' - 'number of plots created'.

Refer to the [Section 4.6.7 - Plot Summary Tab](#) for information concerning the Plot Summary tab.

For example, the first plot created for Blend-1 is named Blend-1-0, and any subsequent plots would have the number after the dash incrementally increased. All stored plots are listed on the Plot Summary tab.

Plot labels can not be modified within the Distribution tab Blend view.

To edit plot labels, you must clone the plot using the Clone and shelf this plot button. The BlendPlot appears and is stored in the Plot Summary tab.

If changes are made to the names or end temperatures in any of the standard fractionation cuts, the radio button automatically switches to User Custom.

An example distribution plot is shown in the following figure.

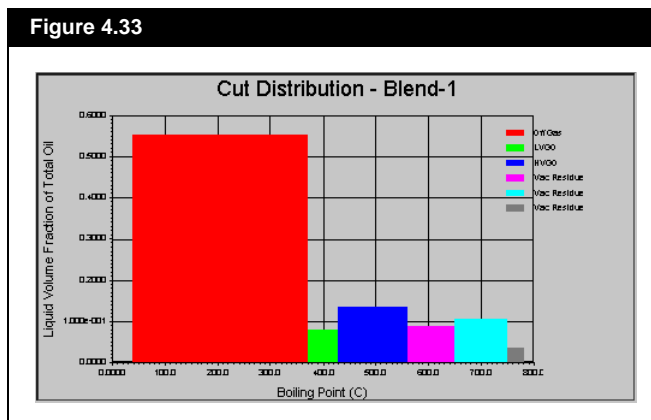

4.6.6 Composite Plot Tab

The Composite Plot tab allows you to visually check the match between the input assay data and the calculated property curves. The choice for the graphical comparison is made from the **Property** drop-down list:

- Distillation
- Molecular Weight
- Density
- Viscosity
- User Property

Click the **Clone and shelf this plot** button to store the current plot. HYSYS automatically names the plot with the following format: 'the name of the active blend'-'number of plots created'.

Refer to the [Section 4.6.7 - Plot Summary Tab](#) for information concerning the Plot Summary tab.

For example, the first plot created for Blend-1 is named Blend-1-0, and any subsequent plots have the number after the dash incrementally increased. All stored plots are listed on the **Plot Summary** tab.

Plot labels can not be modified within the Composite tab Blend view.

To edit plot labels, you must clone the plot using the **Clone and shelf this plot** button. The BlendPlot appears and is stored in the **Plot Summary** tab.

An example molecular weight curve comparison is shown in the following figure.

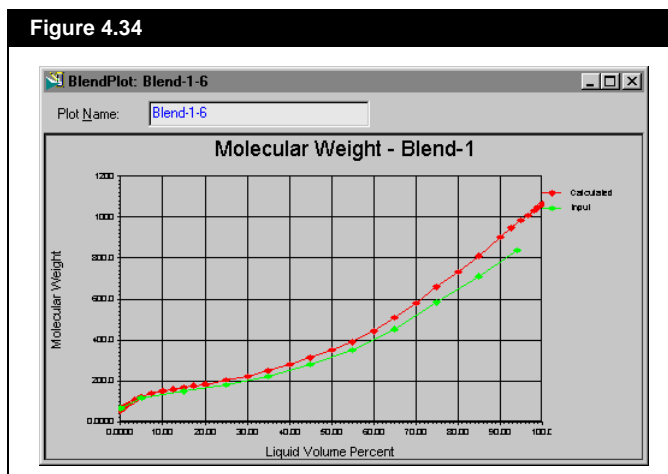

The calculated molecular weight lies above the input curve (instead of over-laying it) because the calculated curve has been shifted to match an input bulk MW.

4.6.7 Plot Summary Tab

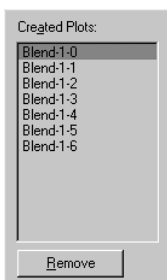

On this tab, you can view the list of stored plots for the current blend. From the Created Plots group you can access any stored plots or remove plots from the list. The list of created plots are generated from the Property, Distribution, and Composite Plots tabs and shown below.

Access a plot by double-clicking on its name or by object inspecting its name and selecting View from the menu. From the BlendPlot view, you can edit plot labels by right-clicking and selecting the graph control option. This method of modifying plots is preferable, since you can plot what you want and that there is a single location for viewing them.

The cloned plots are independent, thus the labels can be modified and are not overwritten. The plotted data for the cloned plots is also updated as the blend changes.

There is no confirmation message when you click the Remove button.

Click the **Remove** button to remove a selected plot from the list. Only one plot can be removed from the list at a time.

4.6.8 Notes Tab

HYSYS provides a tab where you can enter a description of the Blend for your own future reference.

4.7 User Property

A User Property is any property that can be defined and subsequently calculated on the basis of compositions. Examples for oils include R.O.N. and Sulfur content. During the characterization process, all hypocomponents are assigned an appropriate property value. HYSYS then calculates the value of the property for any flowsheet stream. This enables User Properties to be used as Column specifications.

Refer to [Section 4.5.6 - User Curves Tab](#) for an explanation of attaching User Properties to existing Assays.

After User Properties are installed, you can then supply assay information as for Viscosity, Density or Molecular Weight Curves.

4.7.1 User Property Tab

The User Property tab of the Oil Characterization property view is shown below:

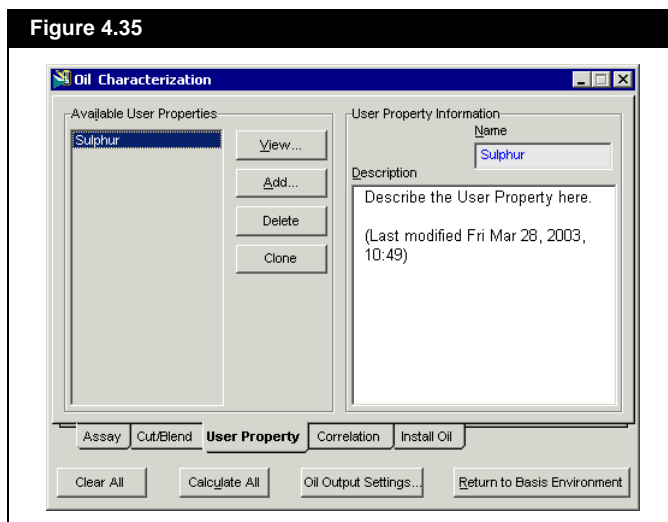

As described in the Oil Characterization View section:

- The **Clear All** button is used to delete all Oil Characterization Information.
- The **Calculate All** button re-calculates all Assay and Blend information.
- The **Oil Output Settings...** button allows you to change IBP, FBP, ASTM D86, and ASTM D2887 interconversion methods for output related calculations.

The Available User Properties are listed in the left portion of the view. The following User Property manipulation buttons are available:

Button	Description
View	Edit the currently highlighted User Property.
Add	Create a new User Property (see the following section, User Property View).
Delete	Erase the currently highlighted User Property. HYSYS does not prompt for confirmation when deleting a User Property.
Clone	Create a new User Property with the same properties as the currently highlighted User Property. HYSYS immediately opens a new User Property view (see the following section, User Property View).

Note that for a highlighted User Property, you can edit the name and provide a description.

4.7.2 User Property View

Refer to [Chapter 7 - User Properties](#) for detailed information on User Properties.

When you first open this view, the Name field has focus. The name of the User Property must be 12 characters or less.

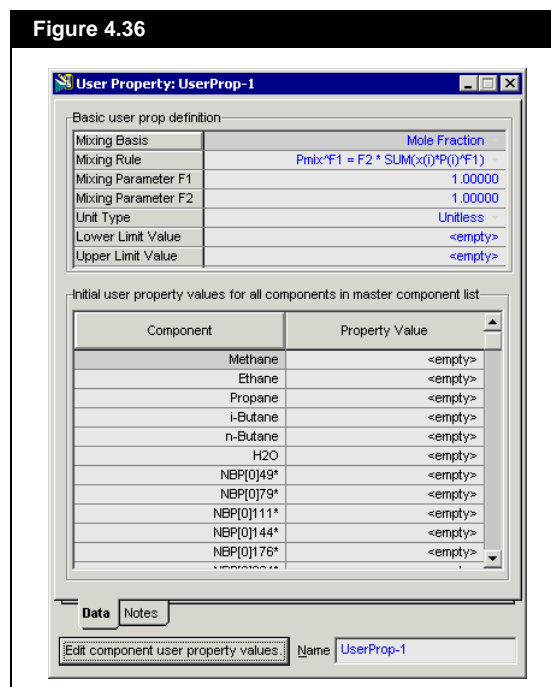

Equation Parameters

The following options are available for the Basic user prop definition group:

Note that the choice of Mixing Basis applies only to the basis that is used for calculating the property in a stream. You supply the property curve information on the same basis as the Boiling Point Curve for your assay.

Refer to [Chapter 7 - User Properties](#) for more detail on the Mixing Rules.

Parameter	Description
Mixing Basis	<p>You have the following options: Mole Fraction, Mass Fraction, Liquid Volume Fraction, Mole Flow, Mass Flow, and Liquid Volume Flow.</p> <p>Note that all calculations are performed using compositions in HYSYS internal units. If you have specified a flow basis (molar, mass or liquid volume flow), HYSYS uses the composition as calculated in internal units for that basis. For example, a User Property with a Mixing Basis specified as molar flow is always calculated using compositions in kg mole/s, regardless of what the current default units are.</p>
Mixing Rule	<p>Select from one of three mixing rules:</p> $(P_{mix})^{f1} = f2 \sum_{i=1}^N (x(i)P(i)^{f1})$ $(P_{mix})^{f1} = f2 \sum_{i=1}^N (x(i) \ln(P(i))^{f1})$ $f1 \cdot P_{mix} + 10^{f2 \cdot P_{mix}} = \sum_{i=1}^N x(i)(f1 \cdot P(i) + 10^{f2 \cdot P(i)})$ <p>where:</p> <p>P_{mix} = total user property value $P(i)$ = input property value for component $x(i)$ = component fraction or flow, depending on the chosen Mixing Basis $f1$ and $f2$ are specified constants</p>
Mixing Parameters	The mixing parameters $f1$ and $f2$ are 1.00 by default. You may supply any value for these parameters.
Unit Type	This option allows you to select the variable type for the user property. For example, if you have a temperature user property, select temperature in the unit type using the drop-down list.

Component User Property Values

Once you have calculated a Blend which includes an Assay with your User Property information, the value of the User Property for each hypocomponent is displayed in the Component User Property Values group.

If you want, you may provide a Property value for all of the Light End components you defined in the Property Package. This is used when calculating the property value for each hypocomponent (removing that portion of the property curve attributable to the Light Ends components).

On this view, you do not provide property curve information. The purpose of this view is to instruct HYSYS how the User Property should be calculated in all flowsheet streams. Whenever the value of a User Property is requested for a stream, HYSYS uses the composition in the specified basis, and calculate the property value using your mixing rule and parameters.

Notes Tab

HYSYS provides a tab where you can enter a description of the User Properties for your own future reference.

4.8 Correlations & Installation

4.8.1 Correlation Tab

Correlation sets can also be viewed through the **Assay** tab - **Correlations and Cut/Blend** tab - **Correlations** tab.

HYSYS allows you to choose from a wide variety of correlations to determine the properties of the generated hypocomponent. From the Correlation tab of the Oil Characterization view, you can create customized Correlation Sets.

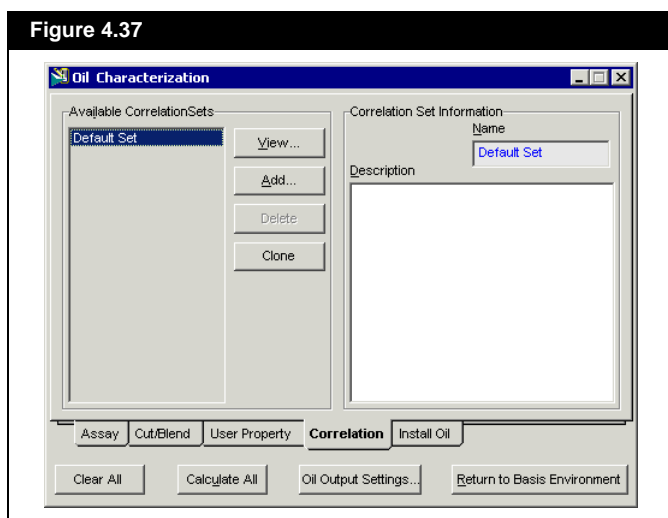

As described in the Oil Characterization View section:

- The **Clear All** button is used to delete all Oil Characterization Information.
- The **Calculate All** button re-calculates all Assay and Blend information.
- The **Oil Output Settings...** button allows you to change IBP, FBP, ASTM D86, and ASTM D2887 interconversion methods for output related calculations.

The Available Correlation Sets are listed on the left side of the view. The following Correlation manipulation buttons are available:

Buttons	Description
View	Edit the currently highlighted Correlation Set.
Add	Create a new Correlation Set (see the following section, Correlation Set View).
Delete	Erase the currently highlighted Correlation Set. HYSYS does not prompt for confirmation when deleting a Correlation Set.
Clone	Create a new Correlation Set with the same properties as the currently highlighted Correlation Set. HYSYS immediately opens a new Correlation Set view (see Correlation Set View).

Note that for a highlighted Correlation Set, you can edit the name and provide a description.

4.8.2 Correlation Set View

When you create or edit a Correlation Set, the following view appears:

Figure 4.38

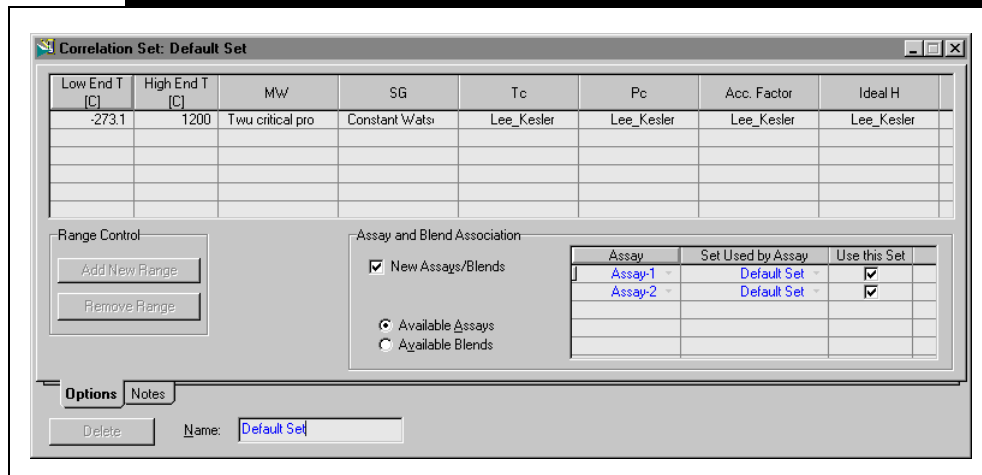

When you first open this view, the Name field has focus. The name of the Correlation Set must be 12 characters or less.

Correlations and Range Control

- The Working Curves are calculated from the Assay data, incorporating the Molecular Weight and Specific Gravity correlations.
- The Hypocomponents are generated based on your cut option selections.
- Finally, the hypocomponent properties are generated:
- The NBP, molecular weight, density and viscosity are determined from the Working curves.
- The remaining properties are calculated, incorporating the critical temperature, critical pressure, acentric factor and heat capacity correlations.

Changes to the Molecular Weight or Specific Gravity correlations are applied to the curve (Assay), while the critical temperature, critical pressure, acentric factor and heat capacity correlations apply to the Blend's hypocomponent properties. Note that changes to the Assay correlations have no effect when you have supplied a property curve (e.g., Molecular Weight); they only apply in the situation where HYSYS is estimating the properties.

To change a correlation, position the cursor in the appropriate column and select a new correlation from the drop-down list.

You cannot change the correlations or range for the Default Correlation Set. If you want to specify different correlations or temperature ranges, you must create a new Correlation Set.

The table below shows the HYSYS defaults and available options for these properties.

Property	Default Correlation	Optional Correlations
MW	Twu	<ul style="list-style-type: none"> • Lee-Kesler • Aspen • Penn State • Katz-Firoozabadi • Hariu-Sage • API • Robinson-Peng • Whitson • Riazi-Daubert • Bergman • Katz-Nokay • Modified Kesler-Lee • Aspen least-squares • Twu
Pc	Lee-Kesler	<ul style="list-style-type: none"> • Rowe • Standing • Lyderson • Penn State • Mathur • Twu • Cavett • Riazi-Daubert • Edmister • Bergman • Aspen
Tc	Lee-Kesler	<ul style="list-style-type: none"> • Rowe • Standing • Nokay • Penn State • Mathur • Spencer-Daubert • Chen-Hu • Meissner-Redding • Cavett • Riazi-Daubert • Edmister • Bergman • Aspen • Roess • Eaton-Porter • Twu
SG	Constant Watson K	<ul style="list-style-type: none"> • Bergman • Yarborough • Lee-Kesler • Bergman-PNA • Hariu-Sage • Katz-Firoozabadi
Ideal Enthalpy	Lee-Kesler	<ul style="list-style-type: none"> • Cavett • Modified Lee-Kesler • Fallon-Watson
Acentric Factor	Lee-Kesler	<ul style="list-style-type: none"> • Edmister • Robinson Peng • Bergman

The Riazi-Daubert correlation has been modified by Whitson. The Standing correlation has been modified by Mathews-Roland-Katz. The default correlations are typically the best for normal hydrocarbon systems. An upper limit of 1250°F (675°C) is suggested for the heaviest component. Although the equations have been modified to extend beyond this range, some caution should be exercised when using them for very heavy systems. Highly aromatic systems may show better results with the Aspen correlations. Detailed discussions including the range of applicability for the correlations is found in [Appendix B - Petroleum Methods/Correlations](#).

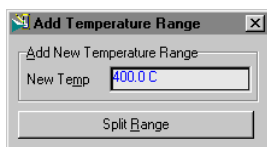

You have the choice of changing a property correlation over the entire range, or making a certain correlation valid for a particular boiling point range only. To split correlations over several boiling ranges click the Add New Range button and the following view appears.

Enter the temperature where you want to make the split into the New Temp cell (in this case 400 °C), and select the Split Range button. The temperature is placed in the correlation set, and the Correlation table is split as shown below:

Figure 4.39

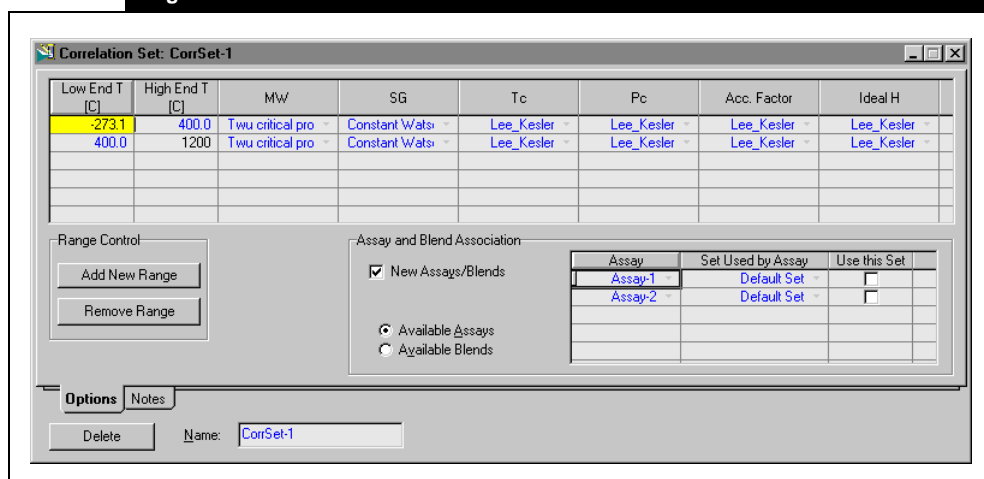

When you merge a range, you delete the correlations for the range whose Low End Temperature is equal to the range temperature you are merging.

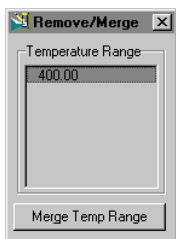

You can now specify correlations in these two ranges. If you want, you may add more splits; or you can also delete a split (merge range) by selecting the Remove Range button as shown in Figure 4.39.

Highlighting the appropriate temperature in the Temperature Range list and selecting the Merge Temp Range button removes or merges the temperature range. When you merge a range, any correlations you chose for that range is forgotten.

Any changes to the correlations for an Input Assay results in first the assay being recalculated, followed by any blend which uses that assay. For an existing oil, it will be automatically recalculated/re-cut using the new correlations, and the new components are installed in the flowsheet.

Assay & Blend Association

The different components of the Assay and Blend Association group are described below:

Object	Description
New Assays/Blends	If you check this, all new Assays and Blends that are created use this Correlation Set.
Available Assays/ Available Blends	These radio buttons toggle between Assay or Blend information.
Assay/Blend Table	This table lists all Assays or Blends with their associated Correlation Sets, depending on which radio button is selected. You can check the Use this Set checkbox to associate the current Correlation Set with that Assay or Blend. Note that you can also select the Correlation Set for a specific Assay on the Correlation tab of that Assay view.

Notes Tab

HYSYS provides a tab where you can enter a description of the Correlations for your own future reference.

4.8.3 Install Oil Tab

The Install Oil tab of the Oil Characterization property view is shown below:

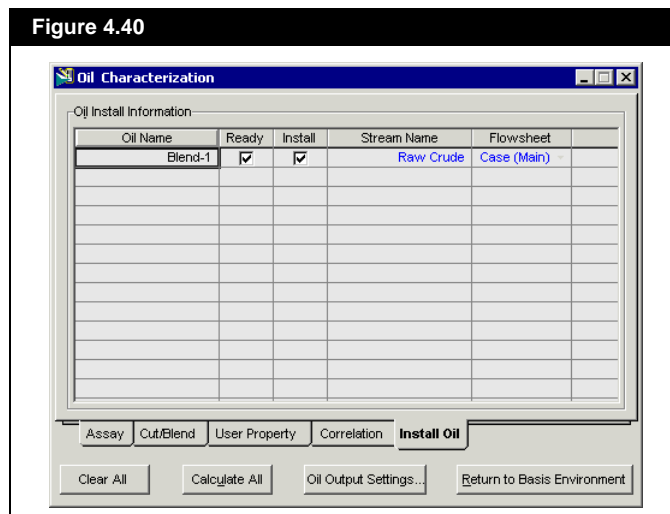

If you want to install the hypocomponent into a non-Associated Fluid Package, Add the Oil Hypo group from the Components tab of that Fluid Package view.

You may install a calculated Blend into your HYSYS case; it appears in the Oil Name column of the table. Simply provide a Stream name for that Blend, and ensure that the Install box is checked. You may use an existing stream name, or create a new one. If you do not provide a name or you deactivate the Install box(es), the hypocomponent is not attached to the fluid package. You can install an oil to a specific subflowsheet in your case by specifying this in the Flow Sheet column.

Each installed Oil appears in the component list as a series of hypocomponents named NBP[1] ***, NBP[2] ***, with the 1 representing the first oil installed, 2 the second, etc.; and *** the average boiling point of the individual Oil components. HYSYS also assigns the Light Ends composition, if present, in the flowsheet stream.

For Blends that contain more than one Assay - each individual Assay is automatically displayed in the Oil Install Information table.

When a Blend is installed in a stream, the relative flow rate of each constituent Assay is defined within the Oil Characterization and cannot be changed. However, if you install each of the constituent Assays (represented by Blends with a single Assay) into their own flowsheet stream, various combinations can be examined using Mixer or Mole Balance operations. The flow and composition for each constituent oil is transferred to your designated flowsheet streams. The flow rate of any specified Oil stream (as opposed to the constituents of a Blend) can be changed at any time by re-specifying the stream rate in the flowsheet section.

4.9 TBP Assay - Example

In this example, a crude oil with a TBP assay curve extending from 100°F to 1410°F is characterized. Associated with this TBP assay are:

- A dependent molecular weight curve
- An independent API gravity curve
- Two independent viscosity curves, one at 100°F and the other at 210°F
- The bulk molecular weight and bulk API gravity
- A liquid volume Light Ends assay for the crude oil

It is desired to split the assay into 38 hypocomponents, with 25°F cuts between 100 and 800°F, 50°F cuts between 800 and 1200°F, and the remaining portion of the crude assay into two components.

The following assay information is available:

Bulk Crude Properties	
MW	300
API Gravity	48.75

Light Ends Liquid Volume%	
Propane	0.0
i-Butane	0.19
n-Butane	0.11
i-Pentane	0.37
n-Pentane	0.46

Dependent property curves have values at the same distillation percentage as the Boiling Temperature assay, but does not need to have values at every percentage.

TBP Distillation Assay		
Liquid Volume%	Temperature (F)	Molecular Weight
0.0	80.0	68.0
10.0	255.0	119.0
20.0	349.0	150.0
30.0	430.0	182.0
40.0	527.0	225.0
50.0	635.0	282.0
60.0	751.0	350.0
70.0	915.0	456.0
80.0	1095.0	585.0
90.0	1277.0	713.0
98.0	1410.0	838.0

API Gravity Assay	
Liq Vol% Distilled	API Gravity
13.0	63.28
33.0	54.86
57.0	45.91
74.0	38.21
91.0	26.01

Viscosity Assay		
Liq Vol% Distilled	Visc. (cP) 100°F	Visc. (cP) 210°F
10.0	0.20	0.10
30.0	0.75	0.30
50.0	4.20	0.80
70.0	39.00	7.50
90.0	600.00	122.30

4.9.1 Initialization

Refer to [Chapter 2 - Fluid Package](#) for details on installing a fluid package.



Oil Environment icon

Refer to the [Section 12.3.1 - Units Page](#) of the **User Guide** for details on creating a customized unit set.

For more information concerning the Trace Window, refer to [Section 1.3 - Object Status Window/ Trace Window](#) of the **User Guide**.

Before you can start the actual characterization process, you must:

1. Begin a new HYSYS case.
2. Select an appropriate property package.
3. Add any non-oil components, including the Light Ends that are to be used in the characterization process, to the component list.

In this case, use the Peng-Robinson equation of state, and select the following components: C3, i-C4, n-C4, i-C5, and n-C5. After you have selected the Light End components, click the Oil Environment icon on the toolbar to enter the Oil Characterization environment.

Prior to the input of assay data, a customized Unit Set is created such that the default units used by HYSYS correspond to the assay data units. Create a customized unit set by cloning the Field unit set. Select API as the new unit for both Mass Density and Standard Density and leave all other Field default units as they are.

You can view a display of important messages related to the progress of the characterization in the Trace Window. If you want, open the Trace Window at the bottom of the Desktop.

The main view in the Oil Environment is the Oil Characterization property view, as shown below:

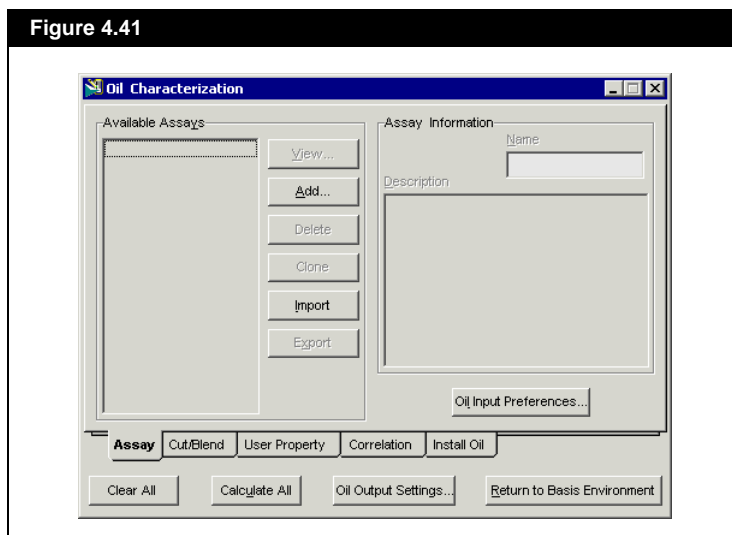

These three steps are the minimum requirements in defining and installing an oil.

The tabs are organized according to the general procedure followed in the characterization of an oil. Completing the characterization requires three steps:

1. Access the **Assay** view by selecting the **Add** button on the **Assay** tab of the Oil Characterization view. Input all of the assay data on the **Input Data** tab of the **Assay** view and click the **Calculate** button.
2. Access the **Cut/Blend** view (which also gives you cutting options) by selecting the **Add** button on the **Cut/Blend** tab of the Oil Characterization property view. Cut the assay into the required number of hypocomponent using the cut points outlined previously.
3. Install the calculated oil from the Oil Environment into the flowsheet by accessing the **Install Oil** tab of the Oil Characterization property view.

Although you can access the User Property tab and the Correlation tab from the Oil Characterization view, neither of these tabs are used in this example.

4.9.2 Step 1 - Input Assay Data

On the Assay tab of the Oil Characterization view, select the Add button. This opens the Assay view and places the active location in the Name cell of the Input Data tab. For this example, change the name of the Assay to Example. The Assay tab is shown below. Note that the first time you enter this view, it is blank, except for the Bulk Properties field and the Assay Data Type field.

The layout of this view depends on:

1. Which Data Type you have selected. This mainly affects what Data Type options are available (Distillation, Light Ends, etc.)
2. Which Input Data radio button you have selected. When you specify that you have Independent or Dependent Molecular Weight, Density or Viscosity data, a new radio button is added to the view. In this view, the TBP Data Type is selected and the Distillation radio button is selected.

Figure 4.42

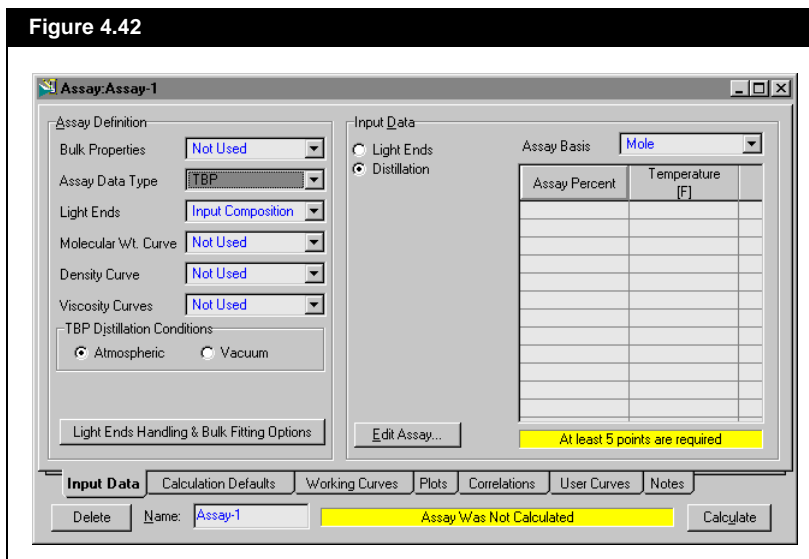

Defining the Assay

The Input Data tab is split into two groups: Assay Definition and Input Data. As its name implies, the Assay Definition group is where the properties of the assay are defined. Since bulk property data is provided, select Used from the Bulk Properties drop-down list. The bulk properties appears in the Input Data group. Next from the Assay Data Type drop-down list, select TBP. The Bulk Props and Distillation radio buttons are now visible.

Light ends can be Auto Calculated by HYSYS, however since you are provided with the light ends data, select Input Compositions from the Light Ends drop-down list.

Now, set the Molecular Weight, Density and Viscosity curve options in each of the respective drop-down lists. The Molecular Weight curve is Dependent, the Density curve is Independent, and the Viscosity curves are also Independent. As you specify these options, radio buttons corresponding to each curve are added to the Input Data group box. Now that the Assay is sufficiently defined, you can begin entering assay data.

Specifying Assay Data

Specification of the Assay occurs in the Input Data group. The field and options visible inside the group are dependent on which radio button is selected in the Input Data group.

HYSYS calculates internal working curves using the supplied property curve data. For each property curve, you can select the method used for the Extrapolation of the working curve. The Extrapolation method for each working curve is specified in the Curve Fitting Methods group of the Calculation Defaults tab.

Bulk Props

Molecular Weight	300.0
Standard Density	48.75 API_60
Watson UDFK	<empty>
Viscosity Type	Dynamic
Viscosity 1 Temp	100.0 F
Viscosity 1	<empty>
Viscosity 2 Temp	210.0 F
Viscosity 2	<empty>

Select the Bulk Props radio button. Input a Bulk Molecular Weight (300) and Bulk Mass Density (48.75 API_60) as shown in the figure below. No bulk viscosity information is available, so leave the Viscosity cells blank. It is not necessary to delete the Viscosity Temperatures as these are ignored if you do not provide bulk viscosities.

Light Ends

Next, select the Light Ends radio button. The Input Data group displays a Light Ends Basis drop-down list and a Light Ends Composition table. From the drop-down list, select LiquidVolume as the Light Ends Basis and enter the Light Ends composition as shown below:

Figure 4.43

Input Data

Bulk Props
 Light Ends
 Distillation
 Molecular Wt
 Density
 Viscosity1
 Viscosity2

Light Ends Basis: Liquid Volume %

Light Ends	Composition	NBP [F]
Propane	0.0000	-43.78
i-Butane	0.1900	10.89
n-Butane	0.1100	31.10
Pentane	0.3700	82.18

Percent of Light Ends in Assay: 1.1300

Distillation

As you enter values into the table, the cursor automatically moves down after each entry, making it easier to supply all values in each column.

Select the Distillation radio button to view the TBP Distillation assay. To enter the data, click the Edit Assay button. The Assay Input Table view appears and enter the following assay data:

Figure 4.44

Assay Percent [%]	Temperature [F]
0.0000	80.00
10.00	255.0
20.00	349.0
30.00	430.0
40.00	527.0
50.00	635.0
60.00	751.0
70.00	915.0
80.00	1095
90.00	1277
98.00	1410
<empty>	<empty>

All input curves except distillation are on midpoint basis. Dependent curves will be shifted to middle.

Cancel OK

Molecular Weight

Select the Molecular Weight radio button to view the Molecular Weight data. Since the Molecular Weight assay is Dependent, the Assay Percentage values that you entered for the Boiling Point Temperature assay are automatically displayed. You need only enter the Molecular Weights as shown below:

Figure 4.45

Assay Percent [%]	Mole Wt.
0.0000	68.00
10.00	119.0
20.00	150.0
30.00	182.0
40.00	225.0
50.00	282.0
60.00	350.0
70.00	456.0
80.00	585.0
90.00	713.0
98.00	838.0

All input curves except distillation are on midpoint basis. Dependent curves will be shifted to middle.

Cancel OK

Density

Select the Density radio button to view (or edit) the Density assay. The default density units are displayed, in this case API. The completed API gravity curve input is shown below:

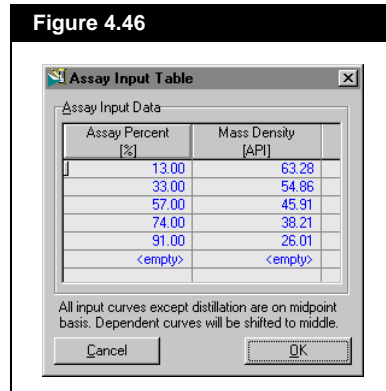

Viscosity

Ensure that the Viscosity Units Type is Dynamic, and that the two temperatures entered are 100°F and 210°F.

Select the Viscosity1 and Viscosity2 radio buttons to view (or edit) the Viscosity assays. When either of these buttons are selected, an additional input box is displayed, which allows you to supply the viscosity temperatures. Make sure the Use Both radio button is selected in the Viscosity Curves group box. The required viscosity input is shown below:

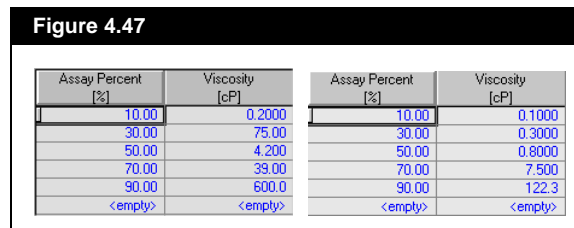

Calculating the Assay

After entering all of the data, go to the Calculation Defaults tab. Note the extrapolation methods displayed in the Curve Fitting Methods group.

Figure 4.48

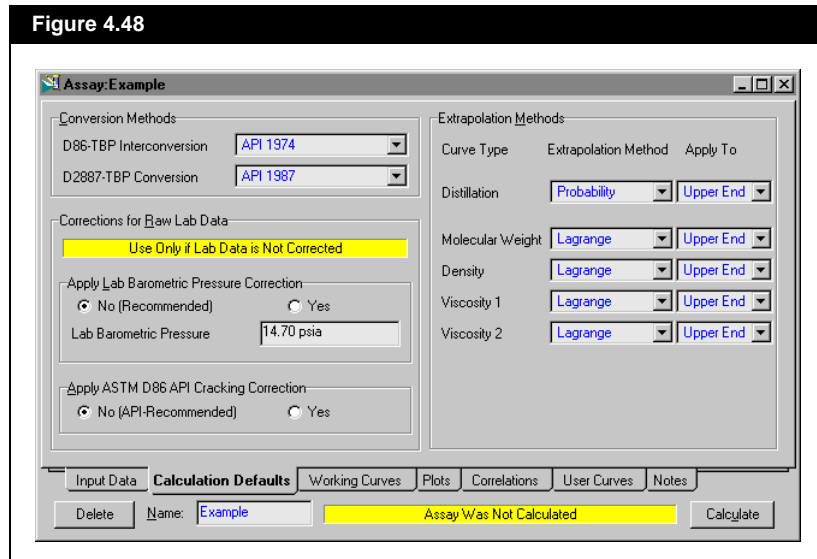

The default extrapolation methods for the working curves are adequate for this assay. To begin the calculation of the assay, press the Calculate button. The status message at the bottom of the Assay view shows the message Assay Was Calculated.

Refer to [Section 4.5 - Characterizing Assays](#) for information on the characterization procedure, working curves and extrapolation methods.

After the Assay is calculated, the working curves are displayed on the Working Curves tab.

Figure 4.49

The screenshot shows a window titled "Assay: Example" with a tab labeled "Assay Working Curves". The window contains a table with the following data:

Point #	Moles	Cum. Moles	NBP [F]	Mole Wt	Mass Density [API]	Viscosity 1 [cP]	Viscosity 2 [cP]
0	0.00000	0.00000	80.00	58.32	108.0	0.120	0.240
1	0.01000	0.01000	89.53	93.07	106.2	0.123	0.066
2	0.01000	0.02000	105.5	96.13	103.5	0.129	0.073
3	0.01000	0.03000	129.9	98.21	98.62	0.135	0.097
4	0.01000	0.04000	155.3	100.6	93.58	0.142	0.168
5	0.01000	0.05000	173.1	102.9	90.44	0.149	0.181
6	0.01000	0.06000	190.3	105.2	87.46	0.157	0.194
7	0.01000	0.07000	206.4	107.4	84.76	0.165	0.207
8	0.01000	0.08000	221.5	109.7	82.30	0.174	0.221
9	0.01000	0.09000	235.6	112.2	80.06	0.184	0.235
10	0.01000	0.10000	248.7	114.7	78.04	0.194	0.249
11	0.02500	0.12500	269.8	119.2	74.88	0.215	0.273
12	0.02500	0.15000	296.1	124.0	72.09	0.249	0.306
13	0.02500	0.17500	318.9	130.0	70.87	0.290	0.335
14	0.02500	0.20000	339.3	136.1	69.77	0.339	0.365

Below the table are tabs for "Input Data", "Calculation Defaults", "Working Curves" (selected), "Plots", "Correlations", "User Curves", and "Notes". At the bottom, there is a "Delete" button, a "Name:" field with "Example" entered, a green progress bar labeled "Assay Was Calculated", and a "Calculate" button.

The working curves for the normal boiling point, molecular weight, mass density and viscosity are regressed from your input curves. HYSYS uses 50 points in the calculation of the working curves, but the molar distribution varies depending on the data you provide. HYSYS moves more points to a region with a steep gradient. The calculation of the Blend is based on these working curves.

The options available in the Property drop-down list correspond to the property curve data specified on the Input Data tab. If only bulk data is provided, there are no plots available.

You can examine graphical representations of your assay data on the Plots tab. Open the Property drop-down list and select the curve that you would like to view. The default plot is the Boiling Point Temperature (Distillation) curve. Because input data for the boiling temperature, molecular weight, density and viscosity were provided, all of these options are shown in the drop-down list.

If multiple assays are blended, repeat the steps outlined in [Section 4.9.2 - Step 1 - Input Assay Data](#).

Figure 4.50

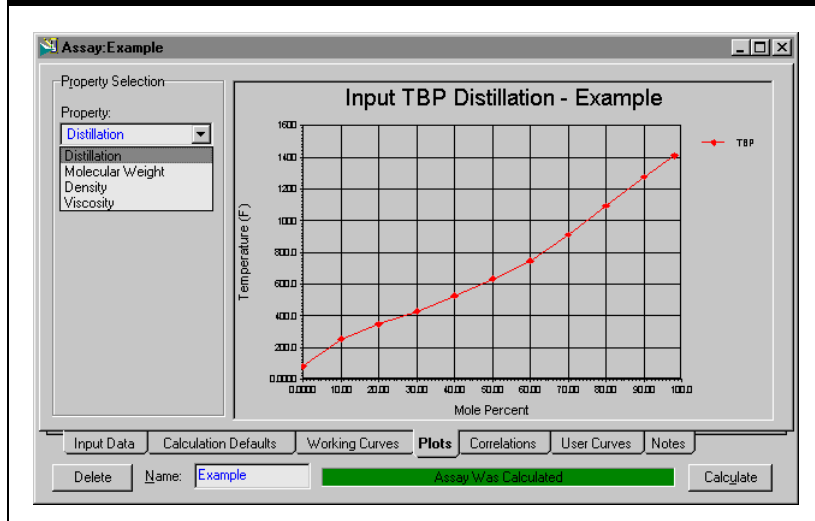

4.9.3 Step 2 - Cut Assay into Hypocomponents

If you have only one Assay, it is not necessary to enter a Flow Rate in the Oil Flow Information table.

You can now cut the Assay into individual hypocomponents. On the Cut/Blend tab of the Oil Characterization view, select the Add button. This takes you to the Blend property view with the list of available assays.

Figure 4.51

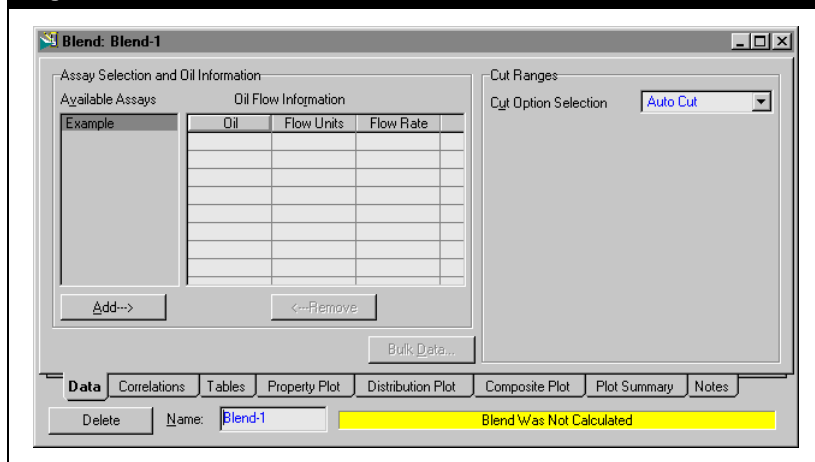

From the Available Assays group, select Example and click the Add button. This adds the Assay to the Oil Flow Information table, and a Blend (Cut) is automatically calculated. The Blend is calculated because the default Cut Option, Auto Cut, appears as soon as a Blend is added. Since the Cut Option was not changed prior to the addition of the Available Assay to the Blend, HYSYS realizes enough information is available to cut the oil and the calculations occur automatically.

Oil Flow Information		
Oil	Flow Units	Flow Rate
Example	Liquid Vol	<empty>

Cut Ranges

Cut Option Selection:

Ranges Selection

Lower Temp Limit: 80.000 F

Upper Temp Limit: 1677.738 F

Starting Cut Point: 100.000 F

Cut End point T [F]	Num. of Cuts
800.000	28
1200.000	8
1410.000	2
<empty>	

Instead of using the default Cut Option, the cut points are defined. From the Cut Option drop-down list, select User Ranges. Enter a Starting Cut Point Temperature of 100°F and fill out the Cut Point table as shown on the left. Click the Submit button to calculate the Blend.

The results of the calculation can be viewed on the Tables tab of the Blend view. The default Table Type is the Component Properties table with the Main Properties radio button selected in the Table Control group.

From the drop-down list, you can also view a Component Breakdown, Molar Compositions, Oil Properties, and Oil Distributions.

Figure 4.52

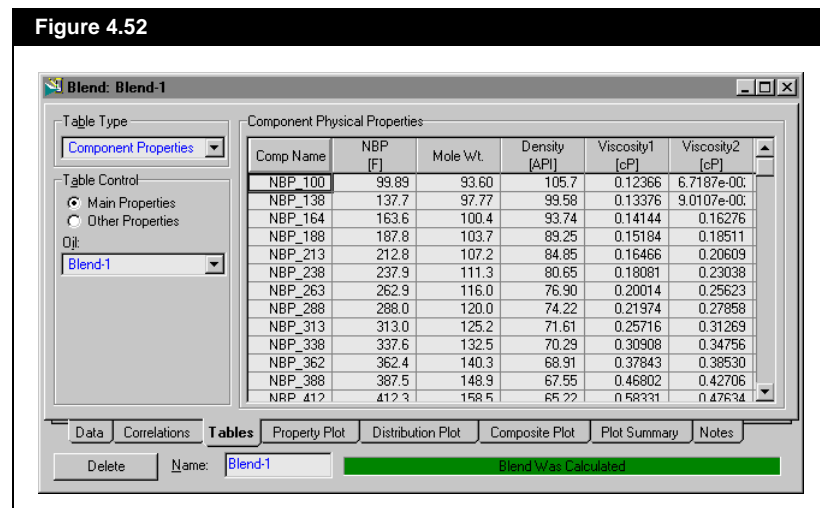

Refer to [Section 4.6.3 - Tables Tab](#) for details on the information available on the Tables tab.

All of the data that is found on the Tables tab can be viewed graphically from the following three tabs:

- Property Plot
- Distribution Plot
- Composite Plot

On the Distribution Plot tab, select Liquid Volume fraction from the Basis drop-down list. The following plot is displayed:

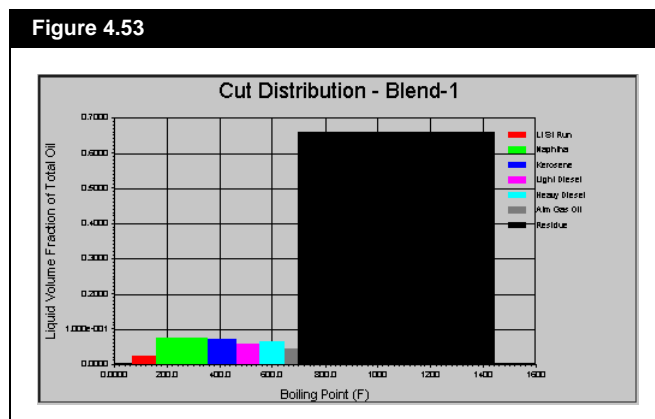

Refer to the tab subsections in [Chapter 4.6 - Hypocomponent Generation](#) for information on the available plots.

The Cut Distribution Plot, as shown above, displays the volume fraction of the oil that would be recovered in various products. This graph is particularly useful in providing estimates for distillation products.

4.9.4 Step 3 - Transfer Information to Flowsheet

The final step of the characterization is to transfer the hypocomponent information into the flowsheet.

On the Install Oil tab of the Oil Characterization view, enter the Stream Name Example Oil, to which the oil composition is being transferred.

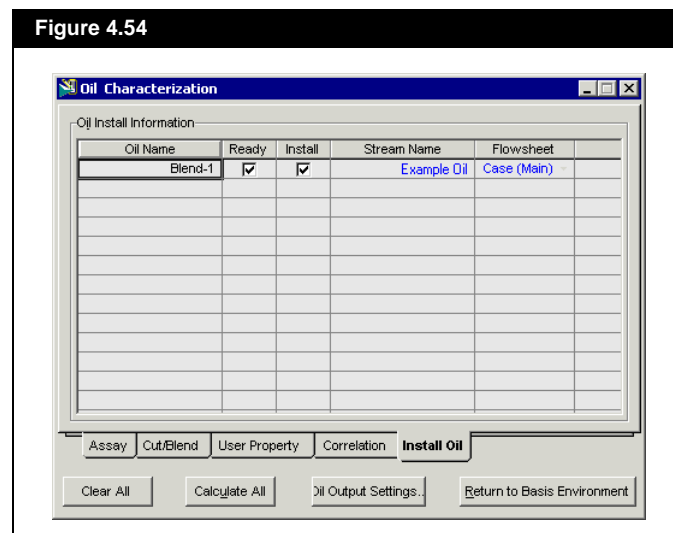

HYSYS assigns the composition of your calculated Oil and Light Ends into this stream, completing the characterization procedure. Also, the hypocomponent is placed into a Hypo group named Blend1 and installed in the fluid package. When you leave the Oil Characterization environment, you are placed in the Basis environment. It is here that you can examine individual hypothetical components that make-up your oil.

Enter the Simulation Environment and move to the Workbook to view the stream you just created. The Compositions page displaying the stream Example Oil is shown below.

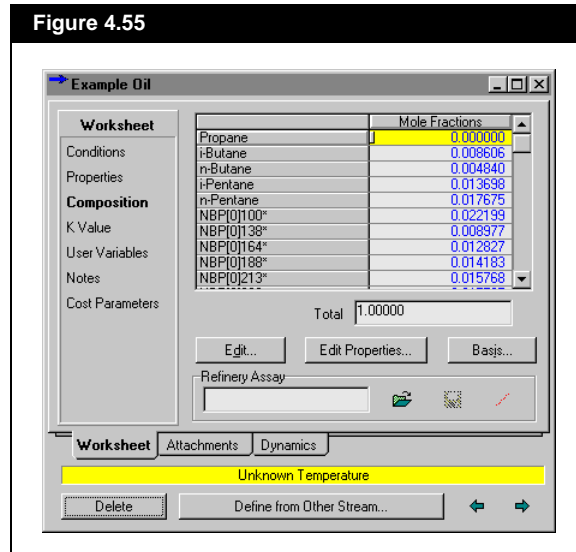

If you decide that some of the hypocomponent parameters need to be recalculated, you can return to the Oil Environment at any time to make changes. To edit an Assay, highlight it on the Assay tab of the Oil Characterization property view, and click the Edit button. If you want to see the effect of using a different correlations on your oil, you can access this information on the Correlation tab of the Oil Characterization view.

4.9.5 Fluid Package Association

In the example shown in [Figure 4.56](#), there is only one fluid package for the flowsheet. Specifying the stream name (Example Oil) not only creates the stream in the flowsheet, but adds the Hypo group (which contains all of the individual hypocomponents) to the fluid package.

Figure 4.56

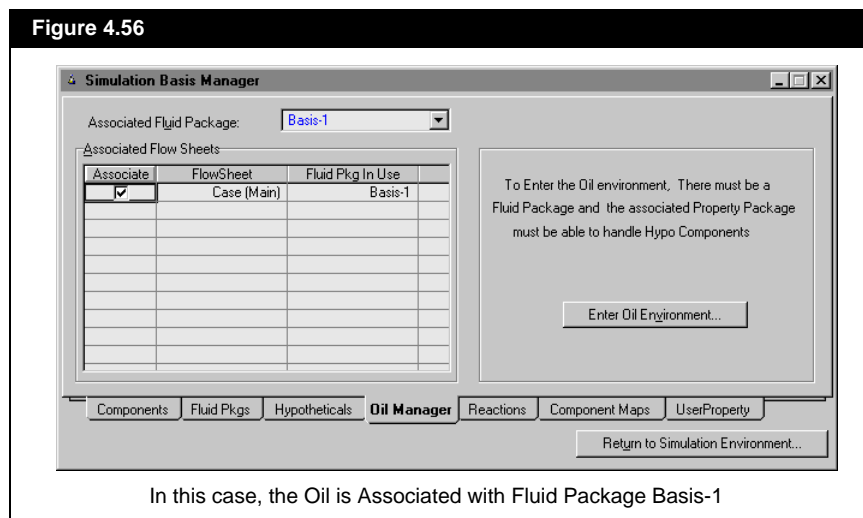

In this case, the Oil is Associated with Fluid Package Basis-1

When there are multiple fluid packages in the simulation, you can specify the one with which the Oil is to be associated (accessed through the Oil Manager tab of the Simulation Basis Manager view). This serves two functions: first, it identifies which pure components are available for a light ends analysis, and second, it identifies the fluid package to which the Hypo group is being installed.

If you do not want to associate the oil to the fluid package, you can deactivate the Associate checkbox.

4.10 Sulfur Curve - Example

The User Property option in the Oil Characterization environment allows you to supply a property curve and have HYSYS characterize it with an Assay. Each hypocomponent is assigned a property value when the Blend is characterized. You can specify the basis upon which the property should be calculated (mole, mass or liquid volume, and flows or fractions), as well as which mixing rule should be used.

In this example, a TBP curve with an associated Sulfur Curve is installed. There is no Light Ends analysis available, so the Auto Calculate Light Ends option is used.

4.10.1 Fluid Package

Prior to entering the Oil Characterization environment, create a Fluid Package with Peng-Robinson as the property method and C1, C2, C3, i-C4, and n-C4 as the components. The choice of the Light Ends components is influenced by the Sulfur Curve data (refer to [Section 4.10.3 - Install the Assay](#) section).



Oil Environment Button

You can also add a User Property via the User Property tab in the Simulation Basis Manager.

4.10.2 Install a User Property

Enter the Oil Environment by clicking the Oil Environment button on the toolbar. To supply a User Curve for an assay, you must first add a User Property. On the User Property tab of the Oil Characterization view, select Add to access the User Property view as shown below.

Figure 4.57

The screenshot shows the 'User Property: Sulphur' dialog box. It is divided into two main sections: 'Basic user prop definition' and 'Initial user property values for all components in master component list'.

Basic user prop definition:

Mixing Basis	Mole Fraction
Mixing Rule	$P_{mix} \cdot F1 = F2 \cdot \sum(x_i \cdot P_i) \cdot F1$
Mixing Parameter F1	1.00000
Mixing Parameter F2	1.00000
Unit Type	Unitless
Lower Limit Value	<empty>
Upper Limit Value	<empty>

Initial user property values for all components in master component list:

Component	Property Value
Methane	<empty>
Ethane	<empty>
Propane	<empty>
i-Butane	<empty>
n-Butane	<empty>

At the bottom, there are tabs for 'Data' and 'Notes'. Below the tabs is a text box labeled 'Edit component user property values...' with a 'Name' field containing 'Sulphur'.

The default options are used for the Equation Parameters except for the Mixing Basis field. Sulfur is quoted on a w/w basis so, select Mass Fraction from the drop-down list. HYSYS automatically names and numbers the User Properties. You can provide a descriptive Name for the property, such as Sulfur.

Note that HYSYS gives you the option of providing a Component User Property Value for each Light End component. If, for example, this was a Heating Value Property, you would supply each component value at this point. These components do not have a "Sulfur value", so they can be left at 0.

4.10.3 Install the Assay

Create an Assay by clicking the Add button on the Assay tab of the Oil Characterization view. Select TBP as the Assay Data Type, specify a Liquid Volume% as the Assay Basis, and leave the TBP Distillation Conditions group at the default settings.

Since no Light Ends analysis is provided, select the Auto Calculate from the Light Ends drop-down list. The Auto Calculate procedure replaces the portion of the TBP curve which is covered by the Boiling Point range of the Light Ends components. In this way, the initial boiling point of the TBP working curve is slightly higher than the normal boiling point of the heaviest Light End component.

The TBP curve starts at -25°C. Taking this information into account, Light End components with boiling points that lie within the first two percent of the TBP assay were chosen. In this way, the benefits of the Auto Calculate procedure are gained without losing a significant portion of our property curve.

There is no Molecular Weight, Density, or Viscosity data, so you can leave the curve options as Not Used. On the Calculation Defaults tab, the extrapolation method for the Distillation curve can be left at its default, Probability. Note that there are no bulk properties. Provide the boiling temperature data, as tabulated below:

TBP Data					
Assay%	Temp (C)	Assay%	Temp (C)	Assay%	Temp (C)
0.02	-25	20.73	180	71.43	500
0.03	-20	24.06	200	73.86	520
0.05	-10	27.55	220	76.22	540
0.31	0	30.93	240	78.46	560
0.52	10	34.32	260	80.57	580
0.55	20	37.83	280	82.55	600
1.25	30	41.21	300	84.41	620
2.53	40	44.51	320	86.16	640
2.93	50	48.01	340	87.79	660
3.78	60	51.33	360	89.32	680
4.69	70	54.58	380	90.67	700
5.67	80	57.73	400	93.48	750
7.94	100	60.65	420	95.74	800

TBP Data					
Assay%	Temp (C)	Assay%	Temp (C)	Assay%	Temp (C)
10.69	120	63.39	440	98.78	900
13.84	140	66.16	460		
17.28	160	68.90	480		

The Assay view with the TBP Data is shown below:

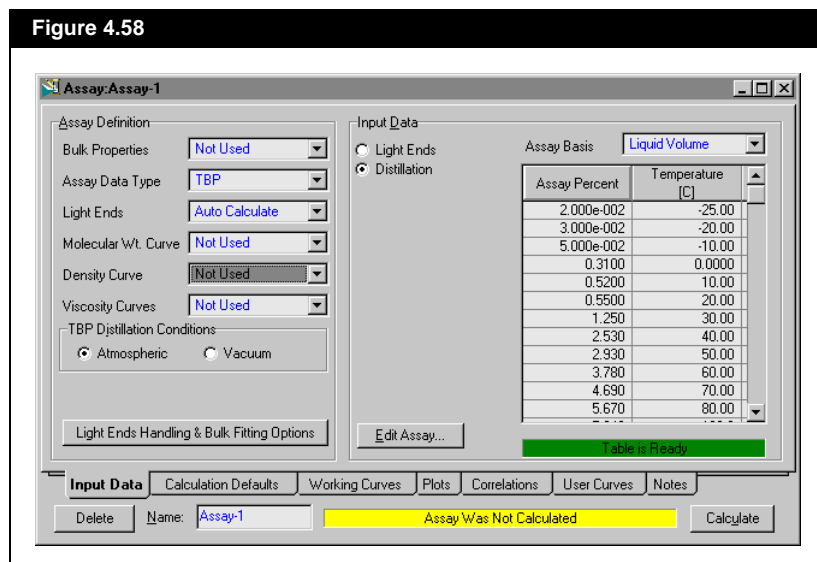

Sulfur Curve

On the User Curves tab of the Assay property view, select the Available User Property Sulfur and click the Add button. In the User Curve Data group, select Independent as the Table Type and ensure that the Bulk Value cell displays <empty>. Click the Edit button and enter the Sulfur Curve Data shown below in the Assay Input Table.

Sulfur Curve Data			
Assay%	Sulfur Value	Assay%	Sulfur Value
0.90	0.032	54.08	2.733
7.38	0.026	55.85	2.691
11.48	0.020	57.17	2.669
16.42	0.083	60.00	2.670

Sulfur Curve Data			
Assay%	Sulfur Value	Assay%	Sulfur Value
22.40	0.094	64.47	2.806
26.68	0.212	68.40	3.085
31.78	0.616	72.09	3.481
36.95	1.122	75.66	3.912
42.04	1.693	78.99	4.300
47.14	2.354	82.05	4.656
48.84	2.629	84.85	4.984
50.52	2.786	87.38	5.286
52.22	2.796	90.33	5.646

After this data is entered, click the Calculate button found at the bottom of the Assay property view.

4.10.4 Create the Blend

A Blend is created using the Auto Cut option. On the Cut\Blend tab of the Oil Characterization view, select the Add button. On the Data tab of the Blend view, highlight Assay-1 from the list of Available Assays and click the Add button. The assay is now added to the Oil Flow Information table. The Blend is immediately calculated, as the default Cut Option is Auto Cut.

Figure 4.59

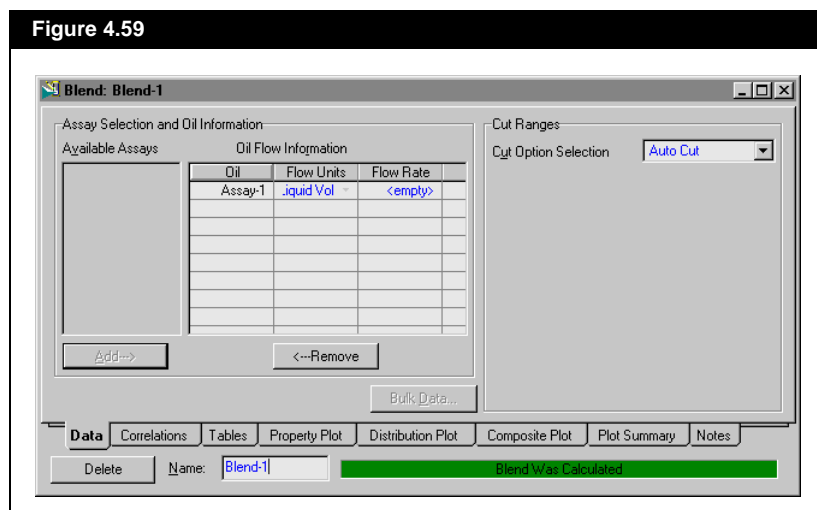

You can return to the User Property tab of the Oil Characterization view and click the View button to display the Sulfur User Property view.

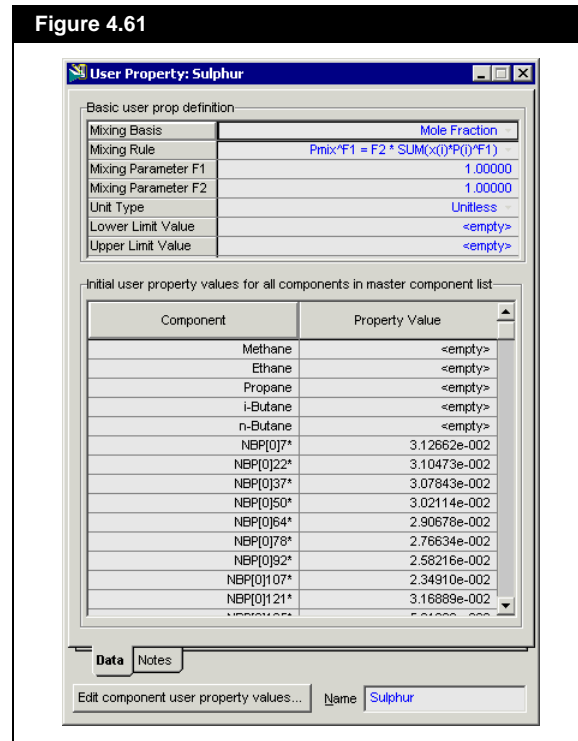

In the Component User Property Values group, note that the Property Value is calculated for all the hypocomponents for the blend. You can scroll through the table to view the Property Value for each hypocomponent.

From the Composite Plot tab of the Blend view, you can view a plot of the Calculated and Inputted values for the User Property. Select User Property from the Property drop-down list and activate the Sulfur checkbox to view the following figure.

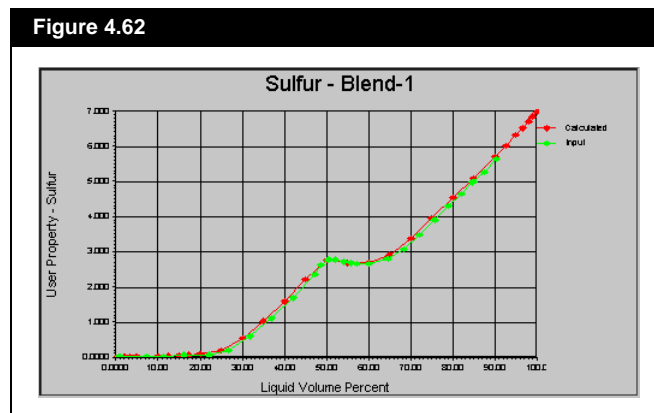

4.11 References

- ¹ Figure 3A1.1, Chapter 3, API Technical Data Book, Fourth Edition (1980).
- ² Procedure 3A1.1, Chapter 3, API Technical Data Book, Fifth Edition (1987).
- ³ Procedure 3A1.1, Chapter 3, API Technical Data Book, Sixth Edition (1994).
- ⁴ Edmister, W.C., and Okamoto, K.K., "Applied Hydrocarbon Thermodynamics, Part 12: Equilibrium Flash Vaporization Correlations for Petroleum Fractions", *Petroleum Refiner*, August, 1959, p. 117.
- ⁵ Procedure 3A3.1, Chapter 3, API Technical Data Book, Fifth Edition (1987).
- ⁶ Procedure 3A3.2, Chapter 3, API Technical Data Book, Sixth Edition (1994).
- ⁷ Procedure 3A3.1, Chapter 3, API Technical Data Book, Sixth Edition (1994).

5 Reactions

5.1 Introduction	2
5.2 Reaction Component Selection	3
5.2.1 Adding Components from Basis Manager.....	4
5.2.2 Selections Within the Reaction Manager	4
5.2.3 Library Reaction Components.....	5
5.3 Reactions	6
5.3.1 Manipulating Reactions	7
5.3.2 Conversion Reaction	7
5.3.3 Equilibrium Reaction	11
5.3.4 Kinetic Reaction	18
5.3.5 Heterogeneous Catalytic Reaction.....	23
5.3.6 Simple Rate Reaction.....	29
5.4 Reaction Sets	32
5.4.1 Manipulating Reaction Sets.....	33
5.4.2 Reaction Set View	33
5.4.3 Exporting/Importing a Reaction Set.....	38
5.4.4 Adding a Reaction Set to a Fluid Package.....	39
5.4.5 Reactions in the Build Environment	39
5.5 Generalized Procedure	40
5.6 Reactions - Example	42
5.6.1 Add Components to the Reaction Manager	42
5.6.2 Create a Reaction	42
5.6.3 Add the Reaction to a Reaction Set	43
5.6.4 Attach the Reaction Set to a Fluid Package.....	44

5.1 Introduction

Reactions within HYSYS are defined inside the Reaction Manager. The Reaction Manager, which is located on the Reactions tab of the Simulation Basis Manager, provides a location from which you can define an unlimited number of reactions and attach combinations of these reactions in Reaction Sets. The Reaction Sets are then attached to Unit Operations in the Flowsheet.

The Reaction Manager is a versatile, time-saving feature that allows you to do the following:

- Create a new list of components for the Reactions or simply use the fluid package components.
- Add, Edit, Copy, or Delete Reactions and Reaction Sets.
- Attach Reactions to various Reaction Sets or attach Reaction Sets to multiple Fluid Packages, thus eliminating repetitive procedures.
- Import and Export Reaction Sets.

Figure 5.1

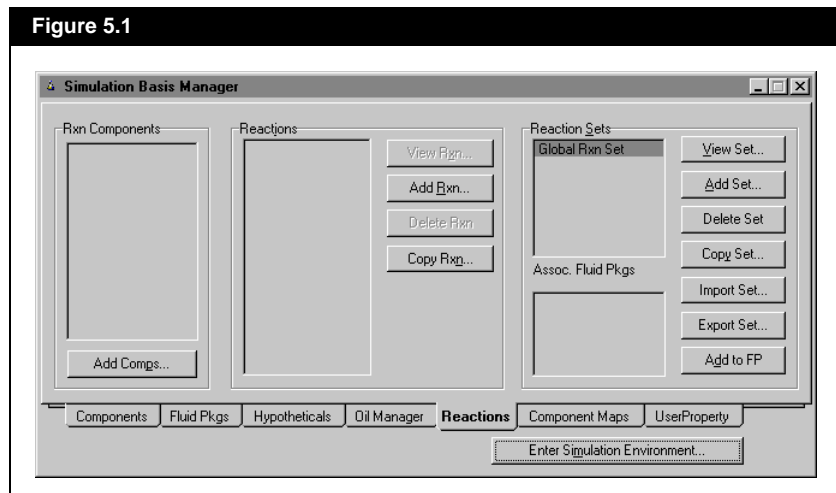

5.2 Reaction Component Selection

On the Reactions tab of the Simulation Basis Manager, there are three main groups which are described below:

Group	Description
Rxn Components	Displays all components available to the Reaction Manager and the Add Comps button.
Reactions	Displays a list of the defined reactions and four buttons available to help define reactions.
Reaction Sets	Displays the defined reactions sets, the associated fluid packages and several buttons that help to define reaction sets and attach them to fluid packages.

Each of the main groups within the Reaction Manager are examined in more detail. In this section, the Rxn Components group is described. The features in the Reactions group and Reaction Sets group are detailed in subsequent sections.

There are three distinct ways in which components can be made accessible to Reactions in the Reaction Manager:

- You can add components on the Component tab of the Simulation Basis Manager. The components are added to the component list and are available in the Rxn Components group to be attached to the Reaction Set. These components are also included in the fluid package depending on the component list selected for the package.
- You can install components directly in the Reaction Manager without adding them to a specific component list by clicking the Add Comps button. The Component List view appears and you can add reaction components for the reaction. These components appear automatically in the master component list, but not in the component list selected for the fluid package. When a Reaction Set (containing a Reaction which uses the new components) is attached to a fluid package, the components which are not present in the fluid package are automatically transferred.
- You can select an Equilibrium Reaction from the Library tab of the Equilibrium Reactor property view. All components used in the reaction are automatically installed in the Reaction Manager. Once the Reaction Set (containing the Library reaction) is attached to a fluid package, the components are automatically transferred to the fluid package.

Refer to [Chapter 1 - Components](#) for more information on adding components.

Refer to [Section 5.4 - Reaction Sets](#) for details on attaching a fluid package.

5.2.1 Adding Components from Basis Manager

Hypocomponents created using the Oil Manager can be used in Reactions. They are listed as Associated Components if they are installed in a fluid package. See [Chapter 4 - HYSYS Oil Manager](#) for details on hypocomponent.

With this method of component selection, components are selected on the Components tab from the Simulation Basis Manager. Add a component list by clicking the Add button. From the Component List View, select the components which are required for the reaction. This is similar to adding components to a component list for a particular fluid package or case. All components that are selected are displayed and available in the Rxn Components group of the Reaction Manager.

The components listed in the Selected Reaction Components group are available to any Reaction that you create.

5.2.2 Selections Within the Reaction Manager

At least one fluid package must exist before components can be transferred from the Reaction Manager.

Components can be made available prior to the creation of Reactions by directly selecting them within the Reaction Manager. By selecting the components within the Reaction Manager, you are not required to transfer component information from the fluid package. The components appear in the Master Component list, but not in the component list. Once a Reaction Set is attached to a fluid package, HYSYS automatically transfers all of the components contained within the Reaction(s) to the fluid package.

The following procedure demonstrates the steps required when beginning with a new case:

1. Create a new case by clicking the **New Case** icon on the toolbar.
2. On the Fluid Pkgs tab of the Simulation Basis Manager, click the **Add** button. A new fluid package is created and its property view opens. Close the Fluid Package property view.
3. Move to the **Reactions** tab. Click the **Add Comps** button in the Rxn Components group and the Component List view is displayed.
4. Select either traditional or hypothetical components. The procedure for selecting components is similar to the selection of components for the fluid package.
5. Return to the Reaction Manager to create the Reaction(s) and install the Reaction(s) within a Reaction Set. See [Section 5.3 - Reactions](#), and [Section 5.4 - Reaction Sets](#) for details.



New Case icon

6. Attach the Reaction Set to the fluid package created in Step #2. See [Section 5.4.4 - Adding a Reaction Set to a Fluid Package](#) for details.
7. All components used in the Reaction(s) that are contained within the Reaction Set are now available in the fluid package.

5.2.3 Library Reaction Components

When a Library Equilibrium Reaction is selected, all of its constituent components are automatically added to the Reaction Manager. You can then use the components in the Rxn Components group of the Reaction Manager to define other reactions. Library reactions can be installed prior to the addition of components to the case. You are not required to add components using the Component List view or Reaction Manager.

To add a Library reaction, do the following:

1. From the Reaction Manager, click the **Add Rxn** button in the Reactions group.
2. Highlight **Equilibrium** from the Reactions view and click the **Add Reaction** button.
3. Move to the **Library** tab of the Equilibrium Reaction property view and select a reaction from the Library Equilibrium Rxns group.

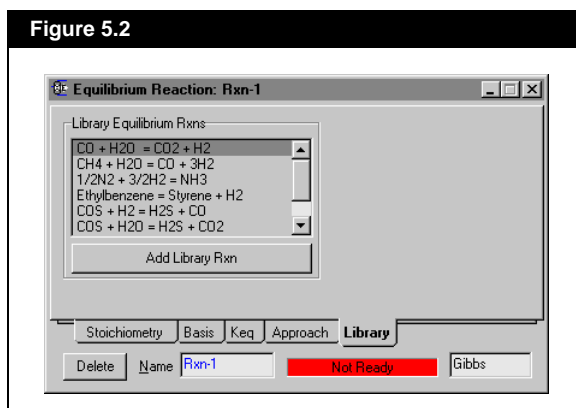

4. Click the **Add Library Rxn** button. All library information concerning the reaction is transferred to the various tabs of the Equilibrium Reaction property view. The components used by the reaction are now shown in the Rxn Components group of the Reaction Manager.

5.3 Reactions

Refer to [Section 5.4 - Reaction Sets](#) for information on Reaction Sets.

In HYSYS, a default reaction set, the Global Rxn Set, is present in every simulation. All compatible reactions that are added to the case are automatically included in this set. A Reaction can be attached to a different set, but it also remains in the Global Rxn Set unless you remove it. To create a Reaction, click the Add Rxn button from the Reaction Manager.

The following table describes the five types of Reactions that can be modeled in HYSYS:

Reaction Type	Requirements
Conversion	Requires the stoichiometry of all the reactions and the conversion of a base component in the reaction.
Equilibrium	Requires the stoichiometry of all the reactions. The term $\ln(K)$ may be calculated using one of several different methods, as explained later. The reaction order for each component is determined from the stoichiometric coefficients.
Heterogeneous Catalytic	Requires the kinetics terms of the Kinetic reaction as well as the Activation Energy, Frequency Factor, and Component Exponent terms of the Adsorption kinetics.
Kinetic	Requires the stoichiometry of all the reactions, as well as the Activation Energy and Frequency Factor in the Arrhenius equation for forward and reverse (optional) reactions. The forward and reverse orders of reaction for each component can be specified.
Simple Rate	Requires the stoichiometry of all the reactions, as well as the Activation Energy and Frequency Factor in the Arrhenius equation for the forward reaction. The Equilibrium Expression constants are required for the reverse reaction.

Each of the reaction types require that you supply the stoichiometry. To assist with this task, the Balance Error tracks the molecular weight and supplied stoichiometry. If the reaction equation is balanced, this error is equal to zero. If you have provided all of the stoichiometric coefficients except one, you may select the Balance button to have HYSYS determine the missing stoichiometric coefficient.

Reactions can be on a phase specific basis. The Reaction is applied only to the components present in that phase. This allows different rate equations for the vapour and liquid phase in same reactor operation.

5.3.1 Manipulating Reactions

When you right-click a reaction in the Reactions group, you can select View or Delete from the Object Inspect menu.

From the Reaction Manager, you can use the four buttons in the Reactions group to manipulate reactions. The buttons are described below:

Button	Command
View Rxn	Accesses the property view of the highlighted reaction.
Add Rxn	Accesses the Reactions view, from which you select a Reaction type.
Delete Rxn	Removes the highlighted reaction(s) from the Reaction Manager.
Copy Rxn	When selected, the Copy Reactions view appears where you can select an alternate Reaction Type for the reaction or duplicate the highlighted reaction.

5.3.2 Conversion Reaction

By default, conversion reactions are calculated simultaneously. However you can specify sequential reactions using the Ranking feature. See [Section 5.4 - Reaction Sets](#).

The Conversion Reaction requires the Stoichiometric Coefficients for each component and the specified Conversion of a base reactant. The compositions of unknown streams can be calculated when the Conversion is known.

Consider the following Conversion reaction:



where: a , b , c and d = the respective stoichiometric coefficients of the reactants (A and B) and products (C and D)

A = the base reactant

B = the base reactant not in a limiting quantity

In general, the reaction components obey the following reaction stoichiometry:

$$\begin{aligned}
 N_A &= N_{A_o}(1 - X_A) \\
 N_B &= N_{B_o} - \frac{b}{a}N_{A_o}X_A \\
 N_C &= N_{C_o} + \frac{c}{a}(N_{A_o}X_A) \\
 N_D &= N_{D_o} + \frac{d}{a}(N_{A_o}X_A)
 \end{aligned}
 \tag{5.2}$$

where: N_* = the final moles of component * (*= A, B, C and D)

N_{*o} = the initial moles of component *

X_A = the conversion of the base component A

When you have supplied all of the required information for the Conversion Reaction, the status bar (at the bottom right corner) will change from Not Ready to Ready.

The moles of a reactant available for conversion in a given reaction include any amount produced by other reactions, as well as the amount of that component in the inlet stream(s). An exception to this occurs when the reactions are specified as sequential.

Stoichiometry Tab

The Stoichiometry tab of a conversion reaction is shown in the figure below:

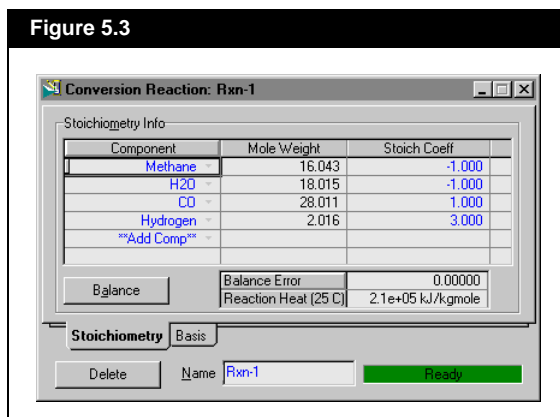

For each Conversion reaction, you must supply the following information:

Input Field	Information Required
Reaction Name	A default name is provided which may be changed. The previous view shows the name as Rxn-1.
Components	The components to be reacted. A minimum of two components are required. You must specify a minimum of one reactant and one product for each reaction you include. Use the drop-down list to access the available components. The Molecular Weight of each component is automatically displayed.
Stoichiometric Coefficient	Necessary for every component in the reaction. The Stoichiometric Coefficient is negative for a reactant and positive for a product. You may specify the coefficient for an inert component as 0, which, for the Conversion reaction, is the same as not including the component in the table. The Stoichiometric Coefficient does not have to be an integer; fractional coefficients are acceptable.

The Reaction Heat value is calculated and displayed below the Balance Error. A positive value indicates that the reaction is endothermic.

Basis Tab

The Basis tab of a conversion reaction is shown in the figure below:

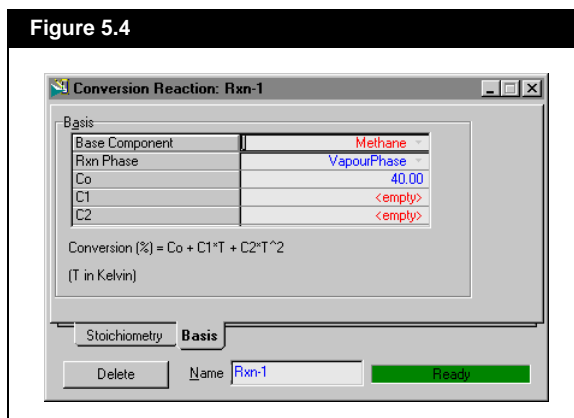

On the Basis tab, you must supply the following information:

You have to add the components to the reaction before the Base Component can be specified.

Sequential Reactions may be modeled in one reactor by specifying the sequential order of solution. See Reaction Rank, in [Section 5.4 - Reaction Sets](#).

Reactions of equal ranking cannot exceed an overall conversion of 100%.

Required Input	Description
Base Component	Only a component that is consumed in the reaction (a reactant) may be specified as the Base Component (i.e., a reaction product or an inert component is not a valid choice). You can use the same component as the Base Component for a number of reactions, and it is quite acceptable for the Base Component of one reaction to be a product of another reaction.
Rxn Phase	The phase for which the specified conversions apply. Different kinetics for different phases can be modeled in the same reactor. Possible choices for the Reaction Phase are: <ul style="list-style-type: none"> • Overall. Reaction occurs in all Phases. • Vapour Phase. Reaction occurs only in the Vapour Phase. • Liquid Phase. Reaction occurs only in the Light Liquid Phase. • Aqueous Phase. Reaction occurs only in the Heavy Liquid Phase. • Combined Liquid. Reaction occurs in all Liquid Phases.
Conversion Function Parameters	Conversion percentage can be defined as a function of reaction temperature according to the following equation: $Conv = Co + C1 \cdot T + C2 \cdot T^2$ <p>This is the percentage of the Base Component consumed in this reaction. The value of <i>Conv.(%)</i> calculated from the equation is always limited within the range of 0.0 and 100%.</p> <p>The actual conversion of any reaction is limited to the lesser of the specified conversion of the base component or complete consumption of a limiting reactant.</p>

To define a constant value for conversion percentage, enter a conversion (%) value for Co only. Negative values for C1 and C2 means that the conversion drops with increased temperature and vice versa.

5.3.3 Equilibrium Reaction

The Equilibrium Reaction computes the conversion for any number of simultaneous or sequential reactions with the reaction equilibrium parameters and stoichiometric constants you provide.

The Equilibrium constant can be expressed as follows:

$$K = \prod_{j=1}^{N_c} \left[([BASE]_{e_j})^{v_j} \right] \quad (5.3)$$

This equation is only valid when BASE (i.e., concentration) is at equilibrium composition.

where: $K = \text{Equilibrium constant}$

$[BASE]_{e_j} = \text{Basis for component } j \text{ at equilibrium}$

$v_j = \text{Stoichiometric coefficient for the } j^{\text{th}} \text{ component}$

$N_c = \text{Number of components}$

The equilibrium constant $\ln(K)$ may be considered fixed, or calculated as a function of temperature based on a number of constants:

$$\ln(K_{eq}) = a + b \quad (5.4)$$

where:

$$a = A + \frac{B}{T} + C \cdot \ln(T) + D \cdot T$$

$$b = E \cdot T^2 + F \cdot T^3 + G \cdot T^4 + H \cdot T^5$$

When you have supplied all of the required information for the Equilibrium Reaction, the status bar (at the bottom right corner) changes from Not Ready to Ready.

Alternatively, you may supply tabular data (equilibrium constant versus temperature), and HYSYS automatically calculates the equilibrium parameters for you. $\ln(K)$ may also be determined from the Gibbs Free Energy.

Stoichiometry Tab

The Stoichiometry tab for an equilibrium reaction is shown in the figure below:

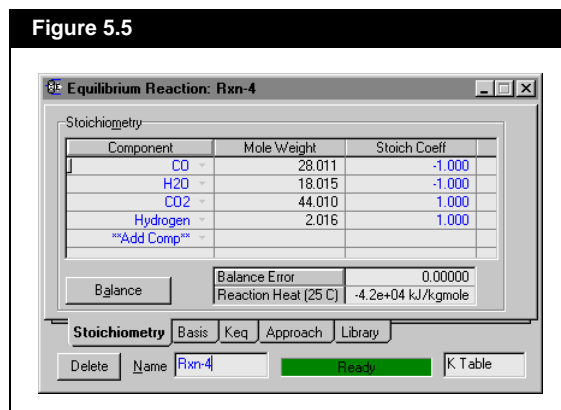

For each reaction, you must supply the following information:

Input Required	Description
Reaction Name	A default name is provided, which may be changed by simply selecting the field and entering a new name.
Components	A minimum of two components is necessary. You must specify a minimum of one reactant and one product for each reaction you include. The Molecular Weight of each component is automatically displayed.
Stoichiometric Coefficient	For every component in this reaction. The Stoichiometric Coefficient is negative for a reactant and positive for a product. You may specify the coefficient for an inert component as 0. The Stoichiometric Coefficient need not be an integer; fractional coefficients are acceptable.

Basis Tab

The Basis tab for an equilibrium reaction contains two groups, the Basis and the Keq Source, which are shown in the figure below

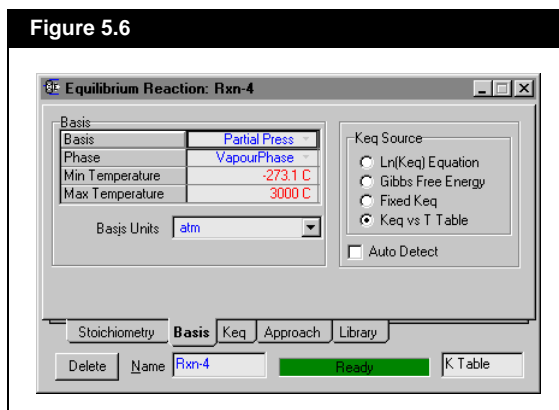

The Basis group requires the following information:

Input Required	Description
Basis	From the drop-down list in the cell, select the Basis for the reaction. For example, select Partial Pressure or Activity as the basis.
Reaction Phase	The possible choices for the Reaction Phase, accessed from the drop-down list, are the Vapour and Liquid Phases.
Minimum Temperature and Maximum Temperature	Enter the minimum and maximum temperatures for which the reaction expressions are valid. If the temperature does not stay within the specified bounds, a warning message alerts you.
Basis Units	Enter the appropriate units for the Basis, or make a selection from the drop-down list.

The Keq Source group contains four radio buttons and a checkbox.

- By selecting the appropriate radio button, you can select one of four options as the Keq Source for the equilibrium reaction.
- If the Auto Detect checkbox is checked, HYSYS automatically changes the Keq Source, depending on the Keq information you provide. For example, if you enter a fixed equilibrium constant, the Fixed Keq radio button is automatically selected. If you later add data to the Table tab, the Keq vs. T Table radio button is automatically selected.

Keq Tab

Depending on which option was selected in the Keq Source group (from the Basis tab), the Keq tab will display the appropriate information.

The following table outlines each of the Keq source options and the respective view on the Keq tab.

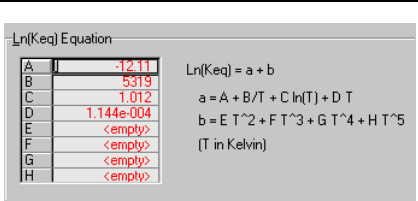
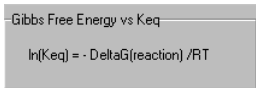
Option	Description	View on Keq Tab
Ln(Keq) equation	<p>Ln(Keq), assumed to be a function of temperature only, is determined from the following equation:</p> $\text{Ln}(Keq) = a + b$ <p>where:</p> $a = A + \frac{B}{T} + C \cdot \ln(T) + D \cdot T$ $b = E \cdot T^2 + F \cdot T^3 + G \cdot T^4 + H \cdot T^5$ <p><i>A, B, C, D, E, F, G, H = the constants defined on the Keq tab.</i></p>	
Gibbs Free Energy	<p>The equilibrium constant is determined from the default HYSYS pure component Gibbs Free Energy (G) database and correlation.</p> <p>The correlation and database values are valid/accurate for a temperature (T) range of 25°C to 426.85°C.</p> <p>If a wider range of G-T correlation is required, the user can clone the library component and input the components Gibbs Free Energy correlation to temperatures beyond the default temperature limit.</p>	

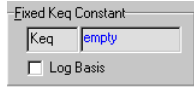
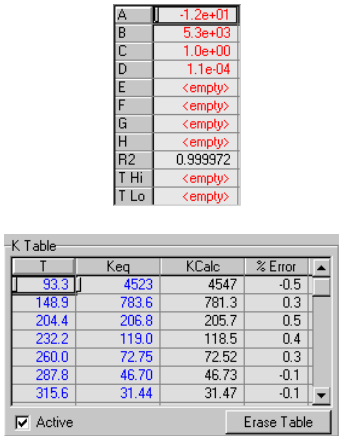
Option	Description	View on Keq Tab																																																						
Fixed K	In this case, the equilibrium constant Keq is considered to be fixed, and is thus independent of temperature. You may specify either Keq or Ln(Keq) on the Keq tab. Check the Log Basis box to specify the equilibrium constant in the form Ln(Keq).																																																							
K vs. T Table	<p>On the Keq tab, you can provide temperature and equilibrium constant data. HYSYS estimates the equilibrium constant from the pairs of data which you provide and interpolates when necessary. For each pair of data that you provide HYSYS calculates a constant in the Ln(K) equation. If you provide at least 4 pairs of data, all four constants A, B, C and D are estimated.</p> <p>The constants may be changed even after they are estimated from the pairs of data you provide, simply by entering a new value in the appropriate cell. If you later want to revert to the estimated value, simply delete the number in the appropriate cell, and it is recalculated.</p> <p>The term R2 gives an indication of the error or accuracy of the Ln(K) equation. It is equal to the regression sum of squares divided by the total sum of squares, and is equal to one when the equation fits the data perfectly.</p> <p>You can also provide the maximum (T Hi) and minimum (T Lo) temperatures applicable to the Ln(K) relation. The constants are always calculated based on the temperature range you provide. If you provide values in the K Table which are outside the temperature range, the calculation of the constants is not affected.</p>	 <table border="1" data-bbox="1064 475 1195 678"> <tbody> <tr><td>A</td><td>-1.2e+01</td></tr> <tr><td>B</td><td>5.3e+03</td></tr> <tr><td>C</td><td>1.0e+00</td></tr> <tr><td>D</td><td>1.1e-04</td></tr> <tr><td>E</td><td><empty></td></tr> <tr><td>F</td><td><empty></td></tr> <tr><td>G</td><td><empty></td></tr> <tr><td>H</td><td><empty></td></tr> <tr><td>R2</td><td>0.999972</td></tr> <tr><td>T Hi</td><td><empty></td></tr> <tr><td>T Lo</td><td><empty></td></tr> </tbody> </table> <table border="1" data-bbox="956 710 1295 913"> <thead> <tr> <th>T</th> <th>Keq</th> <th>KCalc</th> <th>% Error</th> </tr> </thead> <tbody> <tr><td>93.3</td><td>4523</td><td>4547</td><td>-0.5</td></tr> <tr><td>148.9</td><td>783.6</td><td>781.3</td><td>0.3</td></tr> <tr><td>204.4</td><td>206.8</td><td>205.7</td><td>0.5</td></tr> <tr><td>232.2</td><td>119.0</td><td>118.5</td><td>0.4</td></tr> <tr><td>260.0</td><td>72.75</td><td>72.52</td><td>0.3</td></tr> <tr><td>287.8</td><td>46.70</td><td>46.73</td><td>-0.1</td></tr> <tr><td>315.6</td><td>31.44</td><td>31.47</td><td>-0.1</td></tr> </tbody> </table>	A	-1.2e+01	B	5.3e+03	C	1.0e+00	D	1.1e-04	E	<empty>	F	<empty>	G	<empty>	H	<empty>	R2	0.999972	T Hi	<empty>	T Lo	<empty>	T	Keq	KCalc	% Error	93.3	4523	4547	-0.5	148.9	783.6	781.3	0.3	204.4	206.8	205.7	0.5	232.2	119.0	118.5	0.4	260.0	72.75	72.52	0.3	287.8	46.70	46.73	-0.1	315.6	31.44	31.47	-0.1
A	-1.2e+01																																																							
B	5.3e+03																																																							
C	1.0e+00																																																							
D	1.1e-04																																																							
E	<empty>																																																							
F	<empty>																																																							
G	<empty>																																																							
H	<empty>																																																							
R2	0.999972																																																							
T Hi	<empty>																																																							
T Lo	<empty>																																																							
T	Keq	KCalc	% Error																																																					
93.3	4523	4547	-0.5																																																					
148.9	783.6	781.3	0.3																																																					
204.4	206.8	205.7	0.5																																																					
232.2	119.0	118.5	0.4																																																					
260.0	72.75	72.52	0.3																																																					
287.8	46.70	46.73	-0.1																																																					
315.6	31.44	31.47	-0.1																																																					

Approach Tab

Under certain process conditions, an equilibrium reaction may not, actually reach equilibrium. The Equilibrium reaction set uses two types of approach, Fractional and Temperature, to simulate this type of situation. You may select either one or both types of approaches for use in the simulation.

The Approach tab contains two groups, the Fractional Approach and Temperature Approach.

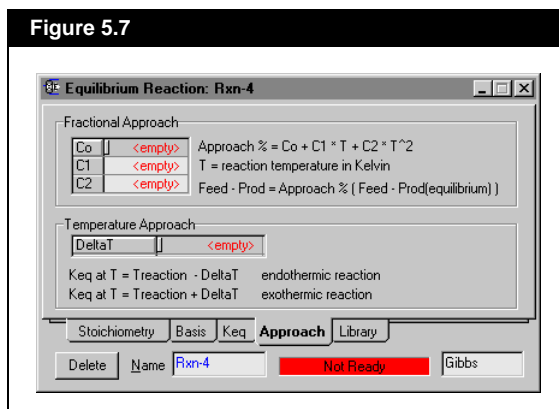

Temperature Approach is not relevant for a fixed Keq source and thus the group does not appear when Fixed Keq is selected from the Basis tab.

Both the Fractional Approach and Temperature Approach methods can be used to simulate an Equilibrium reaction that is a departure from equilibrium.

For the Temperature Approach method, the HYSYS reaction solver will take into account the heat of reaction according to the equations listed. The direction of non-equilibrium departure depends on whether the reaction is endothermic or exothermic.

The Fractional Approach method is an alternative to the Temperature Approach method and is defined according to the following equation:

$$Feed - Product = Approach\% \cdot (Feed - Product)_{equilibrium} \quad (5.5)$$

Equation (5.5) could be interpreted as defining the “actual” reaction extent of the equilibrium as only a percentage of the equilibrium reaction extent of the reaction. In the solver, the value of *Approach %* is limited between 0 and 100%.

Library Tab

The Library tab allows you to add pre-defined reactions from the HYSYS Library. The components for the selected Library reaction are automatically transferred to the Rxn Components group of the Reaction Manager.

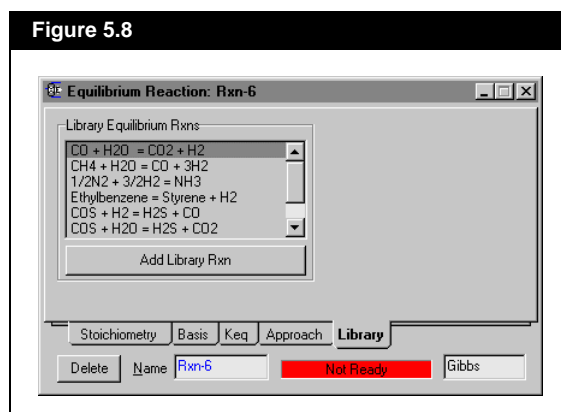

When you select a reaction, all data for the reaction, including the stoichiometry, basis, and $\ln(K)$ parameters, are transferred into the appropriate location on the Equilibrium Reaction property view. To access a library reaction, highlight it from the Library Equilibrium Rxns group and click the Add Library Rxn button.

When K Table contains data input, the library reaction selection will be blocked. You must click the Erase Table button on the Keq tab and before you can add a library reaction.

5.3.4 Kinetic Reaction

To define a Kinetic Reaction, it is necessary to specify the forward Arrhenius Parameters (the reverse is optional), the stoichiometric coefficients for each component, and the forward (and reverse) reaction orders. An iterative calculation occurs, that requires the Solver to make initial estimates of the outlet compositions. With these estimates, the rate of reaction is determined. A mole balance is then performed as a check on the rate of reaction. If convergence is not attained, new estimates are made and the next iteration is executed.

$$r_A = k \cdot f(\text{BASIS}) - k' \cdot f'(\text{BASIS}) \quad (5.6)$$

$$F_{Ao} - F_A + \int^V r_A dV = \frac{dN_A}{dt} \quad (5.7)$$

When you have supplied all of the required information for the Kinetic Reaction, the status bar (at the bottom right corner) changes from Not Ready to Ready.

Equation (5.6) relates the rate of reaction r_A with the reaction rate constants and the basis (e.g. - concentration). **Equation (5.7)** is a mole balance on the unit operation; for steady state solutions, the right side is equal to zero.

Stoichiometry Tab

When the Kinetic Reaction is selected, the following view is displayed:

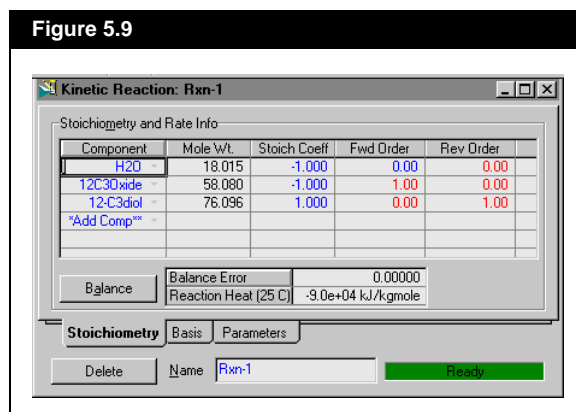

For each reaction, you must supply the following information:

Input Required	Description
Reaction Name	A default name is provided, which may be changed at any time.
Components	You must specify a minimum of one reactant and one product for each reaction you include. Access the available components using the drop-down list. The Molecular Weight of each Component is automatically displayed.
Stoichiometric Coefficient	Necessary for every component in the reaction. The Stoichiometric Coefficient is negative for a reactant and positive for a product. The Stoichiometric Coefficient need not be an integer; fractional coefficients are acceptable. You may specify the coefficient for an inert component as 0, which in most cases is the same as not including the component in the list. However, you must include components that have an overall stoichiometric coefficient of zero and a non-zero order of reaction (i.e., a component that might play the role of a catalyst). The Kinetic Reaction, which allows you to specify the Stoichiometric Coefficient and the order of reaction, makes it possible to correctly model this situation.
Forward and Reverse Orders	These are reaction orders. HYSYS initially fixes the orders of reaction according to the corresponding stoichiometric coefficient. These may be modified by directly entering the new value into the appropriate cell. For instance, in the following reaction: $\text{CO} + \text{Cl}_2 \rightarrow \text{COCl}_2$ the kinetic rate law is $r_{\text{CO}} = k[\text{CO}][\text{Cl}_2]^{3/2}$ <i>When the stoichiometric coefficients are entered for the reaction, HYSYS sets the forward orders of reaction for CO and Cl₂ at 1. Simply enter 1.5 into the Forward Order cell for Cl₂ to correctly model the reaction order.</i>

Thermodynamic Consistency

Crucial to the specification of the reverse reaction equation is maintaining thermodynamic consistency so that the equilibrium rate expression retains the form of [Equation \(5.3\)](#). Failure to do so may produce erroneous results from HYSYS.

Consider the previously mentioned reaction:

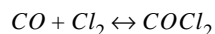

with the forward kinetics following the relationship:

$$rate_{forward} = k_f[\text{CO}][\text{Cl}_2]^{3/2} \quad (5.8)$$

Now suppose you want to add the reverse kinetic reaction. Since the forward reaction is already known, the order of the reverse reaction has to be derived in order to maintain thermodynamic consistency. Suppose a generic kinetic relationship is chosen:

$$rate_{backward} = k_r[CO]^\alpha[Cl_2]^\beta[COCl_2]^\gamma \quad (5.9)$$

where: α , β , and γ = the unknown values of the order of the three components

Equilibrium is defined as the moment when:

$$rate_{forward} - rate_{backward} = 0$$

The equilibrium constant K is then equal to:

$$K = \frac{k_f}{k_r} = \frac{[CO]^\alpha[Cl_2]^\beta[COCl_2]^\gamma}{[CO][Cl_2]^{3/2}} \quad (5.10)$$

To maintain the form of the equilibrium equation seen in [Equation \(5.3\)](#), K is also equal to:

$$K = \frac{[COCl_2]}{[CO][Cl_2]} \quad (5.11)$$

Now combining the two relationships for K found in [Equation \(5.10\)](#) and [Equation \(5.11\)](#):

$$\frac{[CO]^\alpha[Cl_2]^\beta[COCl_2]^\gamma}{[CO][Cl_2]^{3/2}} = \frac{[COCl_2]}{[CO][Cl_2]} \quad (5.12)$$

To maintain thermodynamic consistency: α must be 0, β must be 0.5 and γ must be equal to 1.

Basis Tab

The Basis tab for a kinetic reaction is shown below:

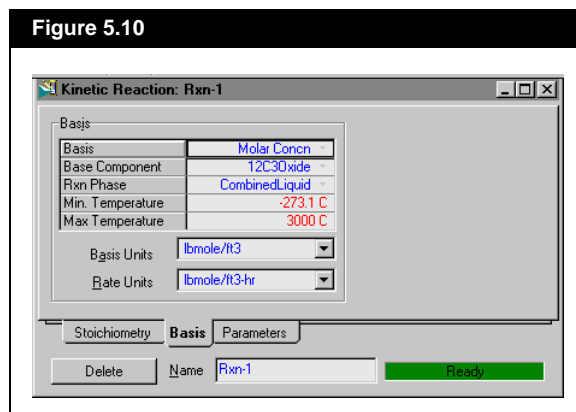

On the Basis tab, the following parameters may be specified:

Input Required	Description
Basis	View the drop-down list in the cell to select the Basis for the reaction. If, for instance, the rate equation is a function of the partial pressures, select Partial Pressure as the Basis.
Base Component	Only a component that is consumed in the reaction (a reactant) may be specified as the Base Component (i.e., a reaction product or an inert component is not a valid choice). You can use the same component as the Base Component for a number of reactions, and it is quite acceptable for the Base Component of one reaction to be a product of another reaction.
Reaction Phase	The phase for which the kinetic rate equations apply. Different kinetic rate equations for different phases can be modeled in the same reactor. Possible choices for the Reaction Phase, available in the drop-down list, are: Overall, Vapour Phase, Liquid Phase, Aqueous Phase, and Combined Liquid.
Minimum Temperature and Maximum Temperature	Enter the minimum and maximum temperatures for which the forward and reverse reaction Arrhenius equations are valid. If the temperature does not remain within these bounds, a warning message alerts you during the simulation.
Basis Units	Enter the appropriate units for the Basis, or make a selection from the drop-down list.
Rate Units	Enter the appropriate units for the rate of reaction, or make a selection from the drop-down list.

Parameters Tab

On the Parameters tab, you may specify the forward and reverse parameters for the Arrhenius equations. These parameters are used in the calculation of the forward and reverse reaction constants.

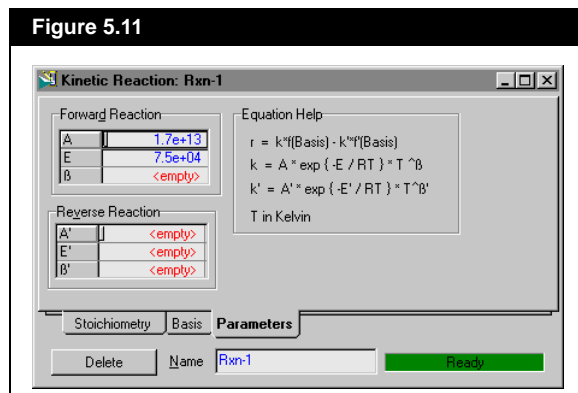

The reaction rate constants are a function of temperature according to the following extended form of the Arrhenius equation:

$$k = A \cdot \exp\left\{-\frac{E}{RT}\right\} \cdot T^{\beta} \quad (5.13)$$

$$k' = A' \cdot \exp\left\{-\frac{E'}{RT}\right\} \cdot T^{\beta'} \quad (5.14)$$

A , E , β , are the Arrhenius Parameters for the forward reaction. A' , E' , and β' are the Arrhenius Parameters for the reverse reaction.

Information for the reverse reaction is not required.

where: k = forward reaction rate constant

k' = reverse reaction rate constant

A = forward reaction Frequency Factor

A' = reverse reaction Frequency Factor

E = forward reaction Activation Energy

E' = reverse reaction Activation Energy

β = forward extended reaction rate constant

β' = reverse extended reaction rate constant

R = Ideal Gas Constant (value and units dependent on the units chosen for Molar Enthalpy and Temperature)

T = Absolute Temperature

If the Arrhenius coefficient, A is equal to zero, there is no reaction. If Arrhenius coefficients E and β are zero, the rate constant is considered to be fixed at a value of A for all temperatures.

5.3.5 Heterogeneous Catalytic Reaction

HYSYS provides a heterogeneous catalytic reaction kinetics model to describe the rate of catalytic reactions involving solid catalyst. The rate equation is expressed in the general form according to Yang and Hougen (1950):

$$-r = \frac{(\text{kinetic term})(\text{potential term})}{(\text{adsorption term})} \quad (5.15)$$

Since these types of reactions involve surface reaction together with adsorption (and desorption) of reactants and products, the resulting rate expression will be strongly mechanism dependent.

Consider the following the simple reaction:

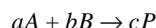

Depending on the reaction mechanism, its reaction rate expression (ignoring reverse rate of reaction) could be:

Langmuir-Hinshelwood Model	$r = \frac{k_+ K_A K_B C_A C_B}{(1 + K_A C_A + K_B C_B + K_P C_P)^2} \quad (5.16)$
Eley-Rideal Model	$r = \frac{k_+ K_B C_A C_B}{(1 + K_B C_B + K_P C_P)} \quad (5.17)$
Mars-van Krevelen Model	$r = \frac{k C_A}{1 + (a/b)(k/k^*) C_A C_B^{-n}} \quad (5.18)$

where: K_* = the adsorption rate constant for component *

k_+ = the forward reaction rate constant

k = reaction rate constant for oxidation of hydrocarbon

k^* = reaction rate constant for surface re-oxidation

HYSYS has provided a general form, as follows, to allow user to build in the form of rate expression they want to use.

$$r = \frac{k_f \prod_{i=1}^{M} C_i^{\alpha_i} - k_r \prod_{j=1}^{M} C_j^{\beta_j}}{\left(1 + \sum_{k=1}^M \left\{ K_k \prod_{g=1}^M C_g^{\gamma_{kg}} \right\} \right)^n} \quad (5.19)$$

where: k_f and k_r = the Rate Constants of the forward and reverse kinetic rate expressions

K = the absorption rate constant

M = number of absorbed reactants and products plus absorbed inert species

The rate constants k_f , k_r and K_k are all in Arrhenius form. You are required to provide the Arrhenius parameters (pre-exponential factor A and activation energy E) for each of these constants.

Note that you may have to group constants, for example in [Equation \(5.16\)](#), $k_f = k_+ K_A K_B$. You must take care in inputting the correct values of the Arrhenius equation. Also note that no default values are given for these constants.

The Heterogeneous Catalytic Reaction option can be used in both CSTR and PFR reactor unit operations. A typical Reaction Set may include multiple instances of the Heterogeneous Catalytic Reaction.

Stoichiometry Tab

When the Heterogeneous Catalytic Reaction is selected, the following view is displayed:

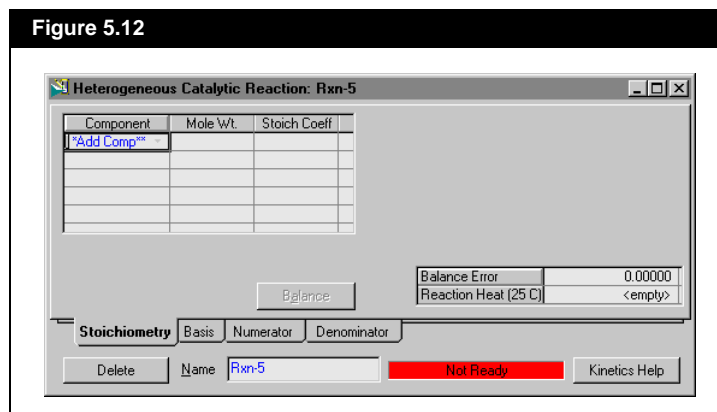

For each catalytic reaction, you must supply the following information:

Input Required	Description
Reaction Name	A default name is provided, which may be changed.
Components	You must specify a minimum of one reactant and one product for each reaction you include. Open the drop-down list in the cell to access all of the available components. The Molecular Weight of each component is automatically displayed.
Stoichiometric Coefficient	Necessary for every component in this reaction. The Stoichiometric Coefficient is negative for a reactant and positive for a product. The Stoichiometric Coefficient need not be an integer; fractional coefficients are acceptable. You may specify the coefficient for an inert component as 0, which in this case is the same as not including the component in the list.

Basis Tab

The Basis tab for a catalytic reaction is shown below:

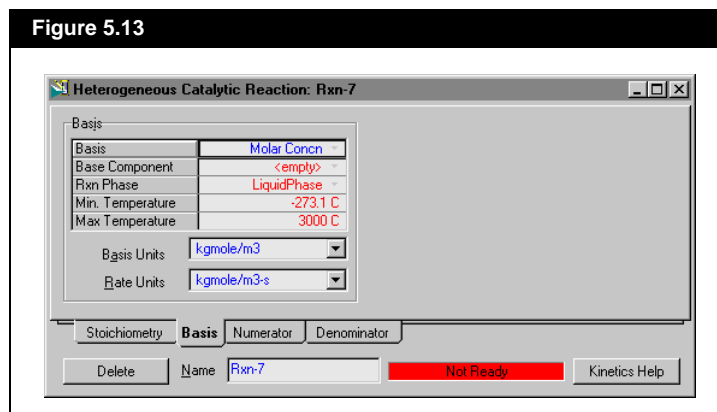

On the Basis tab, the following parameters may be specified:

Input Required	Description
Basis	Open the drop-down list in the cell to select the Basis for the reaction. For example, select Partial Pressure or Molar Concentration as the basis.
Base Component	Only a component that is consumed in the reaction (a reactant) may be specified as the Base Component (i.e., a reaction product or an inert component is not a valid choice). You can use the same component as the Base Component for a number of reactions, and it is acceptable for the Base Component of one reaction to be a product of another reaction.
Reaction Phase	The phase for which the kinetics apply. Different kinetics for different phases can be modeled in the same reactor. Possible choices for the Reaction Phase (available in the drop-down list) are Overall, Vapour Phase, Liquid Phase, Aqueous Phase, and Combined Liquid.
Minimum Temperature and Maximum Temperature	Enter the minimum and maximum temperatures for which the forward and reverse reaction Arrhenius equations are valid. If the temperature does not remain in these bounds, a warning message alerts you during the simulation.
Basis Units	Enter the appropriate units for the Basis, or make a selection from the drop-down list.
Rate Units	Enter the appropriate units for the rate of reaction, or make a selection from the drop-down list.

Numerator Tab

For more information on Kinetic reaction specifications see [Section 5.3.4 - Kinetic Reaction](#).

The Numerator tab is specified in much the same way as you would specify a typical HYSYS Kinetic Reaction. The Numerator tab is shown below:

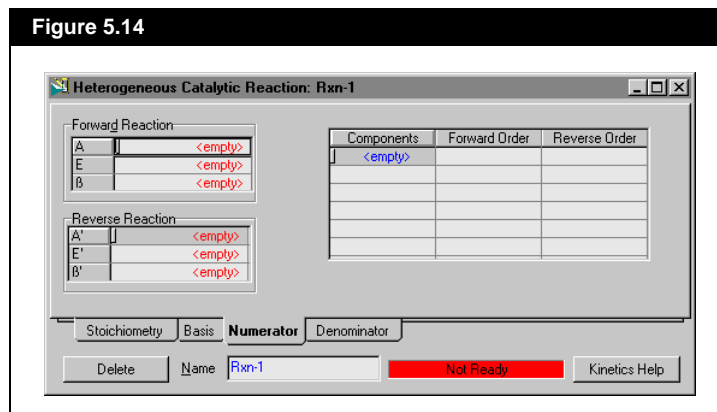

You must supply the forward and reverse parameters of the extended Arrhenius equation. The forward and reverse reaction rate constants are calculated from these values. In addition to the rate constants, you must also specify the reaction order of the various components for both the forward and reverse reactions. This is done by selecting the Components field of the Reaction Order cell matrix, and selecting the appropriate component from the drop-down list and entering values for the Forward and/or Reverse orders.

When specifying Forward and Reverse relationships it is important to maintain thermodynamic consistency. For more information on thermodynamic consistency see [Section 5.3.4 - Kinetic Reaction](#), Thermodynamic Consistency.

Denominator Tab

The Denominator tab for a catalytic reaction is shown in the following figure:

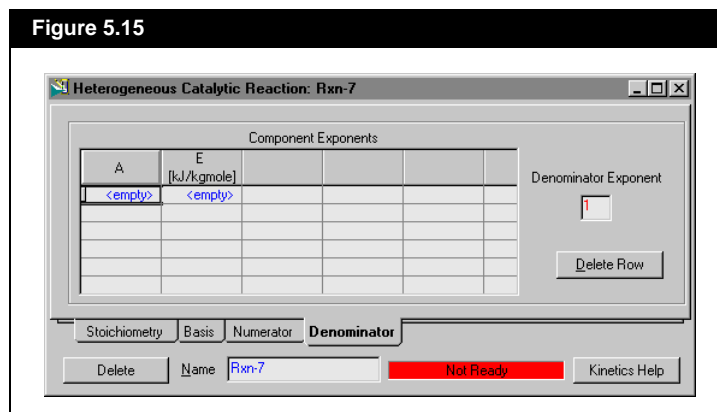

The Denominator tab contains the Component Exponents matrix in which each row represents a denominator term. The A and E columns are for the pre-exponential factor and the activation energy, respectively for the adsorption term (K).

$$\left(1 + \sum_{k=1}^M \left\{ K_k \prod_{g=1}^M C_g^{\gamma_{kg}} \right\} \right)^n \quad (5.20)$$

The remaining columns are used to specify the exponents (γ_{kg}) of the absorbed components (C_g). In order to add a term to the denominator of the kinetic expression, you must activate the row of the matrix containing the <empty> message and add the relevant equation parameter values. The Delete Term button is provided to delete the selected row (or corresponding term) in the matrix. The overall exponent term n is specified in the Denominator Exponent field.

5.3.6 Simple Rate Reaction

When you have supplied all of the required information for the Simple Rate Reaction, the status bar (at the bottom right corner) will change from Not Ready to Ready.

The Simple Rate Reaction is also similar to the Kinetic Reaction, except that the reverse reaction rate expression is derived from equilibrium data.

Stoichiometry Tab

When the Simple Rate Reaction is selected the following view is displayed.

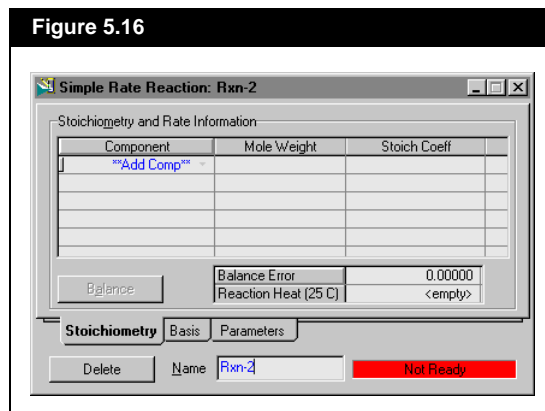

For each reaction, supply the following information:

Field	Description
Reaction Name	A default name is provided, which may be changed.
Components	You must specify a minimum of one reactant and one product for each reaction you include. Open the drop-down list in the cell to access all of the available components. The Molecular Weight of each component is automatically displayed.
Stoichiometric Coefficient	Necessary for every component in this reaction. The Stoichiometric Coefficient is negative for a reactant and positive for a product. The Stoichiometric Coefficient need not be an integer; fractional coefficients are acceptable. You may specify the coefficient for an inert component as 0, which in this case is the same as not including the component in the list.

Basis Tab

The Basis tab for the simple rate reaction is shown below:

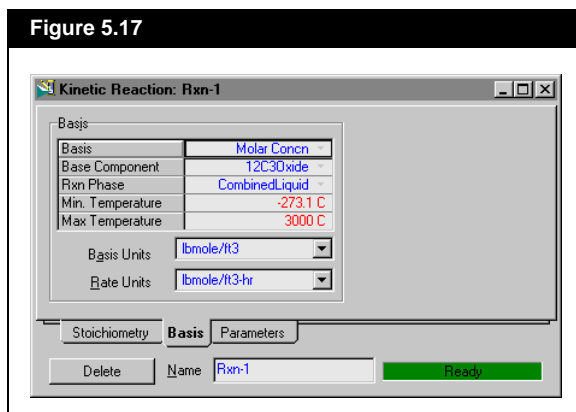

On the Basis tab, the following parameters may be specified:

Parameter	Description
Basis	Open the drop-down list in the cell to select the Basis for the reaction. For example, select Partial Pressure or Molar Concentration as the basis.
Base Component	Only a component that is consumed in the reaction (a reactant) may be specified as the Base Component (i.e., a reaction product or an inert component is not a valid choice). You can use the same component as the Base Component for a number of reactions, and it is acceptable for the Base Component of one reaction to be a product of another reaction.
Reaction Phase	The phase for which the kinetics apply. Different kinetics for different phases can be modeled in the same reactor. Possible choices for the Reaction Phase, available in the drop-down list, are Overall, Vapour Phase, Liquid Phase, Aqueous Phase and Combined Liquid.
Minimum Temperature and Maximum Temperature	Enter the minimum and maximum temperatures for which the forward and reverse reaction Arrhenius equations are valid. If the temperature does not remain in these bounds, a warning message alerts you during the simulation.
Basis Units	Enter the appropriate units for the Basis, or make a selection from the drop-down list.
Rate Units	Enter the appropriate units for the rate of reaction, or make a selection from the drop-down list.

Parameters Tab

The Parameters tab for the rate reaction is shown below:

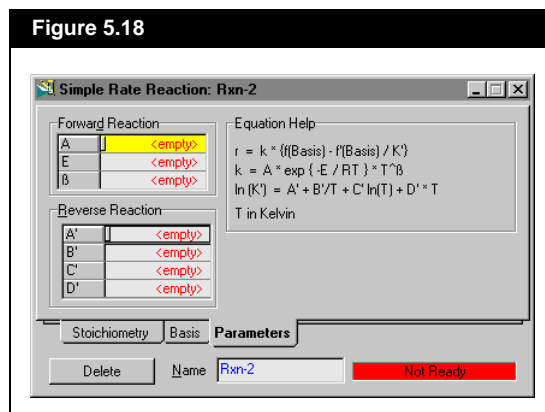

The forward reaction rate constants are a function of temperature according to the following extended form of the Arrhenius equation:

$$k = A \cdot \exp\left[-\frac{E}{RT}\right] \cdot T^{\beta} \quad (5.21)$$

where: k = forward reaction rate constant

A = forward reaction Frequency Factor

E = forward reaction Activation Energy

β = forward extended reaction rate constant

R = Ideal Gas Constant

T = Absolute Temperature

If Arrhenius coefficient A is equal to zero, there is no reaction. If Arrhenius coefficients E and β are equal to zero, the rate constant is considered to be fixed at a value of A for all temperatures.

The reverse equilibrium constant K' is considered to be a function of temperature only:

$$\ln K' = A' + \frac{B'}{T} + C' \ln(T) + D'T \quad (5.22)$$

where: A' , B' , C' and D' = the reverse equilibrium constants

You must supply at least one of the four reverse equilibrium constants.

5.4 Reaction Sets

All Reaction Sets created within the Reaction Manager become available for attachment to your reactor operations in the flowsheet. Reaction Sets may contain more than one reaction. There is limited flexibility for the mixing of reaction types within a Reaction Set. You can have Equilibrium and Kinetic reactions within a single Reaction Set, but you must have a distinct Reaction Set for conversion reactions.

If only one type of reaction is used, all reactions are active in the Global Rxn Set, thereby eliminating the need to explicitly define a new Reaction Set.

HYSYS provides the Global Rxn Set, which contains all compatible reactions that you have defined in the case. If you only add Kinetic and Equilibrium reactions, or exclusively Conversion reactions to the case, all reactions are active within the Global Rxn Set. However, if you add an incompatible mix of reactions (i.e., Conversion and Kinetic), only the type of reactions that are compatible with the first installed reaction are active in the Global Rxn Set.

The same reaction can be active in multiple reaction sets. A new set can be added from the Reaction Manager by selecting the Add Set button.

5.4.1 Manipulating Reaction Sets

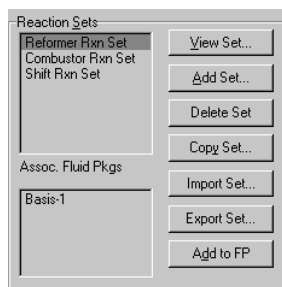

When you right-click a Reaction Set in the Reaction Sets group, you can select View or Delete from the Object Inspect menu.

All Reaction Set manipulations are conducted in the Reaction Sets group of the Reactions tab of the Basis Manager. The following buttons are available in the Reaction Sets group to manipulate reaction sets:

Button	Description
View Set	Displays the property view for the highlighted reaction set.
Add Set	Adds a reaction set to the list of reaction sets and opens its property view.
Delete Set	Removes the highlighted reaction set(s) from the Reaction Manager. You must confirm your action to delete a reaction set.
Copy Set	Duplicates the highlighted reaction set(s).
Import Set	Opens a reaction set from disk into the current case.
Export Set	Saves a reaction set to disk for use in another case.
Add to FP	Accesses the Add 'Reaction Set Name' view, from which you attach the highlighted reaction set(s) to a fluid package. This button is available only when a Reaction Set is highlighted in the Reaction Sets group.

5.4.2 Reaction Set View

When you add a new set, or view an existing one, the Reaction Set view appears as shown below.

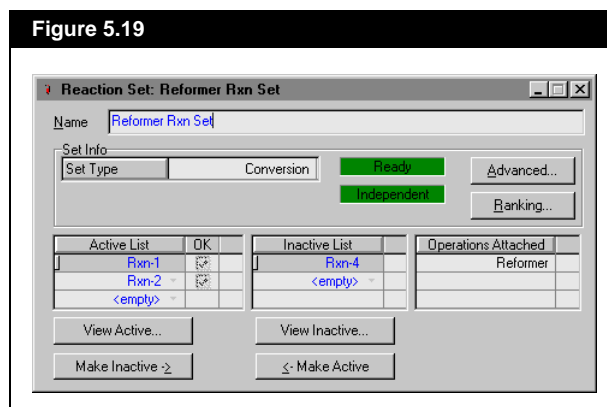

The following table describes the features contained within this view.

Feature	Description
Name	A default Reaction Set name is provided, which can be changed.
Set Type	HYSYS determines the Set Type from the reaction types in the Active List. This field cannot be modified. The Reaction Set types are Conversion, Kinetic, Equilibrium, and Mixed. A Mixed Set Type corresponds to a Reaction Set containing both Kinetic and Equilibrium reactions.
Solver Method	<p>The Solver method is available when dealing with Kinetic reaction sets. Several Solver Methods are available from the drop-down list and explained below:</p> <ul style="list-style-type: none"> • Default. The Reaction Solver attempts to calculate the solution using Newton's Method. If this is not successful, it then uses the Rate Iterated and Rate Integrated Methods. For most cases, it is best to use the Default Solver Method. • Newton's Method. This method usually converges quickly by taking the derivative of the function using the current estimates, and uses these results to obtain new estimates. • Rate Iterated. This method is a partial Newton's method, and assumes that the off-diagonal elements of the Jacobian matrix are equal to zero. The Rate Iterated Method works well when there is very little interaction between reactions. • Rate Integrated. This method integrates the reaction equations until all time derivatives are zero. The Rate Integrated method is stable, but slow. • Auto Selected. Same as Default.
Active List	<p>Reactions may be added to the Active List by positioning the cursor in the Active List column and selecting an existing Reaction from the drop-down list. You may also type the name of an existing reaction directly in the cell that shows <empty>.</p> <p>You can open the property view for any reaction in the Active List by highlighting it and clicking the View Active button. Alternatively, you may double-click on the reaction to view it.</p> <p>A reaction in the Active List may be transferred to the Inactive List simply by selecting the reaction and clicking the Make Inactive button.</p>
Inactive List	<p>Existing reactions may be added to the Inactive List by positioning the cursor in the Inactive List column and selecting a Reaction from the drop-down list.</p> <p>You can access the property view for any reaction in the Inactive List by highlighting it and clicking the View Inactive button. You may also double-click on the reaction to view it.</p> <p>A reaction in the Inactive List may be transferred to the Active List by selecting the reaction and clicking the Make Active button. If this reaction is not independent of other reactions in the Active List, an error message is displayed, and the reaction remains in the Inactive List.</p>
Operations Attached	All operations to which the Reaction Set is attached are listed in this column.

You cannot have two versions of the same reaction with different rate constants in the Active List.

Advanced Features

By clicking the Advanced button, you can view the Advanced reaction options.

Figure 5.20

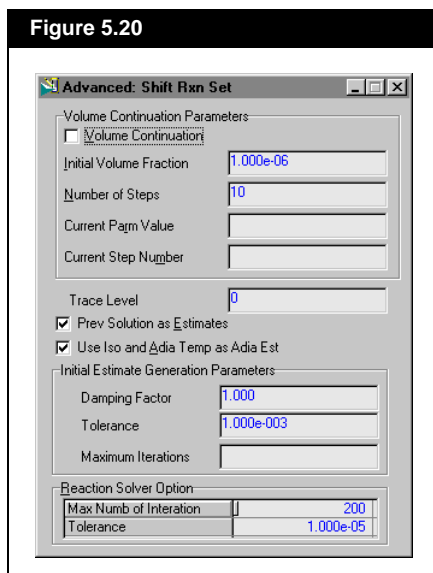

Within the Volume Continuation Parameters group, the following options are available:

Object	Description
Volume Continuation	For most cases, it is not necessary to select this option. In situations where convergence is not easily attained (e.g., high reaction rates), check the Volume Continuation checkbox to enable HYSYS to more easily reach a solution. For Volume Continuation calculations, HYSYS “ramps” the volume starting from the initial volume fraction to the final volume fraction in the specified number of steps. For each successive step, the previous solution is used as the initial estimate for the next step.
Initial Volume Fraction	The default value is 1.0000e-06. This is the Volume Fraction at the start of the calculations.
Number of Steps	The default value is 10. If the solution does not converge, increase this value and re-run the simulation.
Current Parm Value	This field displays the current parameter value.
Current Step Number	This field displays the current step number.

Object	Description
Trace Level	Provides a trace output of the calculations in the Trace Window. The trace level value corresponds to the level of detail that you see in the Trace Window. You are limited to the values 0, 1, 2, or 3.
Prev Solution as Estimates	It is necessary to make an initial estimate of the outlet compositions to obtain the proper solution. Check this checkbox if you want to use the previous solution as the initial estimate. This does not apply to the conversion reaction, since the specified conversion determines the outlet compositions.
Use Iso and Adia Temp as Adia Est	If you calculate a heat flow given a specific temperature, and then use this heat flow as a spec (deleting the temperature specification), HYSYS uses the previously calculated temperature as an estimate for the Adiabatic calculation.

The parameters within the Initial Estimate Generation Parameters group are generally used with Reactions that have a high degree of interaction. You can also use these parameters to give some assistance in obtaining the final solution when the reactor operation fails to converge or when you have a large number of components and reactions. The parameters are described in the following table:

Parameter	Description
Damping Factor	Default is 1.0, indicating that there is no damping. You can change this value. With a lower the damping factor, HYSYS uses smaller steps (slower and more stable) in converging towards the solution.
Tolerance	This is the tolerance set for the Estimate Generation. By default, this is set to 0.001. You are able to change this value.
Maximum Iterations	Maximum number of iterations HYSYS uses. There is no default value, and so you can set whatever value is desired.

The Reaction Solver Option group allows you to set the number of iterations and the tolerance level. The option depends on the boundary condition of the reactor operation which is using the reaction set. For example, when a reactor operation is used to determine the outlet temperature, the number of iterations and tolerance level are used in the reaction solver to search for a solution.

Option	Description
Max Num of Iteration	Controls the maximum number of iterations specified before the reaction solver stops searching for a solution. By default, the value is 200.
Tolerance	The specified tolerance level is the relative error between the energy balance equation and the calculated value by the reaction solver in the iteration. By default, the value is 0.00001.

Reaction Rank

The Ranking button is visible only when the Reaction Set type is Conversion. This option automatically handles most situations where reactions are sequential:

In this case the Rank would be:

$A \rightarrow B$ 1
 $B \rightarrow C$ 2
 $C \rightarrow D$ 3

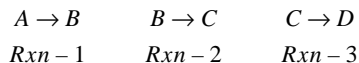

allowing the three reactions to be modeled in a single reactor.

However in situations where there are competing reactions:

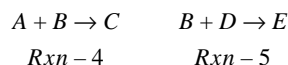

you can use the Ranking factor to specify which conversion value should be applied first. For example, if *Rxn-4* was ranked first, the specified conversion for *Rxn-5* would only be applied to the amount of component B remaining after *Rxn-4* had run to its specified conversion.

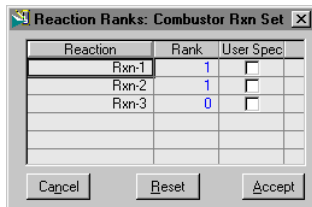

HYSYS assigns default ranks to multiple conversion reactions by examining the reactants and products. For example, you may have a reaction set containing the following:

1. $\text{CH}_4 + \text{H}_2\text{O} \rightarrow \text{CO} + 3\text{H}_2$
2. $\text{CH}_4 + 2\text{H}_2\text{O} \rightarrow \text{CO}_2 + 4\text{H}_2$
3. $\text{CH}_4 + 2\text{O}_2 \rightarrow \text{CO}_2 + 2\text{H}_2\text{O}$

HYSYS notices that a product of Reaction 3, H_2O , is used as a reactant in both Reactions 1 and 2. Since H_2O may not be available until Reaction 3 has occurred, it is assigned a rank of 0 and the other reactions are each given the default Rank of 1. The feed composition is not taken into account, as Reaction Ranks are assigned prior to entering the Build Environment.

To specify the Ranking, you must do so from the Reaction Ranks view, which contains the following fields:

Object	Description
Reaction	This column shows all of the reactions to be ranked.
Rank	Shows the rank for each reaction, which is an integer value. The minimum value is 0 and the maximum is equal to the number of Reactions ranked. Thus, when ranking three sequential reactions, you may rank them 0-1-2 or 1-2-3; both methods give the same results. You may override the default values through the input of new values in the appropriate cells.
User Specified	If you specify the Rank of the reaction, this checkbox is checked.

You can set two or more reactions to have the same Rank; for instance, the ranks for Rxn-1 and Rxn-2 may be 1, and the rank for Rxn-3 may be 2.

The buttons along the bottom of the Reaction Ranks view have the following functions:

Button	Description
Cancel	Closes the view without accepting any changes that were made.
Reset	Resets the Reaction Ranks to the internal default.
Accept	Closes the view, accepting the changes that were made.

5.4.3 Exporting/Importing a Reaction Set

After a Reaction Set is customized with reactions, it can be exported to a file. The same Reaction Set can then be used in another simulation case by importing the file and attaching it to a fluid package. Highlight a Reaction Set in the Reaction Sets group of the Reaction Manager and click the Export Set button.

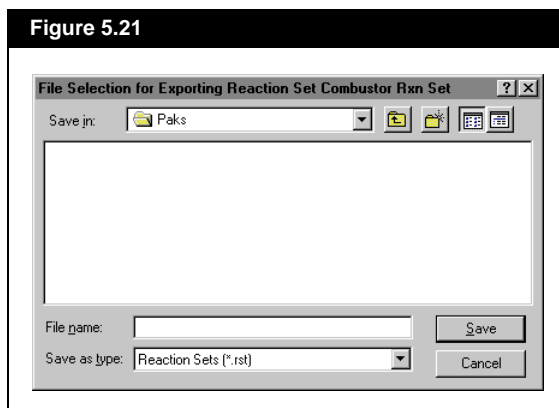

Select a file path (the default is usually satisfactory) and enter a filename with the extension *.rst. Click the **Save** button to export the reaction set to a file.

The Import Set button allows you to introduce an exported Reaction Set into a simulation case. Choose the Reaction Set file (with the extension *.rst) from the list and select the Open button. If the file is not listed in the File Name field, an alternate File Path may be needed.

5.4.4 Adding a Reaction Set to a Fluid Package

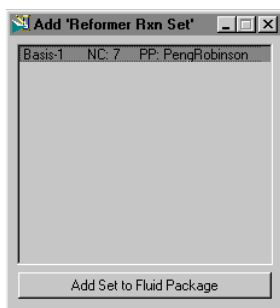

To make a Reaction Set available inside the flowsheet, you must attach it to the fluid package which is associated with the flowsheet. Highlight a reaction set in the Reaction Sets group of the Reaction Manager and click the Add to FP button. The Add 'Reaction Set Name' view appears, where you can highlight a fluid package and click the Add Set to Fluid Package button.

5.4.5 Reactions in the Build Environment

Refer to [Section 5.3 - Reaction Package](#) of the User Guide for more details.

When you are inside the Main or Column Environment you can access the Reaction Package view without having to return to the fluid package. Under Flowsheet in the Main Menu, select Reaction Package.

Refer to the Operation Guide for more information on the individual unit operations.

When a Reaction Set is attached to a unit operation, you can access the Reaction Set view or the view(s) for the associated Reaction(s) directly from the property view of the operation. Some of the unit operations that support reactions include the Reactor operation (conversion, equilibrium, or kinetic), the PFR, the Separator, and the Column.

5.5 Generalized Procedure

The following procedure outlines the basic steps for creating a reaction, creating a reaction set, adding the reaction to the reaction set and then making the set available to the flowsheet. Refer to the Reaction Package view, shown in [Figure 5.1](#), as you follow the procedure:

1. Select **Reaction Package** under **Flowsheet** in the menu bar.
2. On the Reaction Package view, click the **Add Rxn** button to create a new Reaction.
3. A Reactions view appears, from which you must select the type of reaction to create. Select a reaction type and click the **Add Reaction** button.
4. The property view for the reaction type you selected is displayed. Complete the input for the reaction until **Ready** appears as the status message. You can close the Reaction property view, if desired.

Figure 5.22

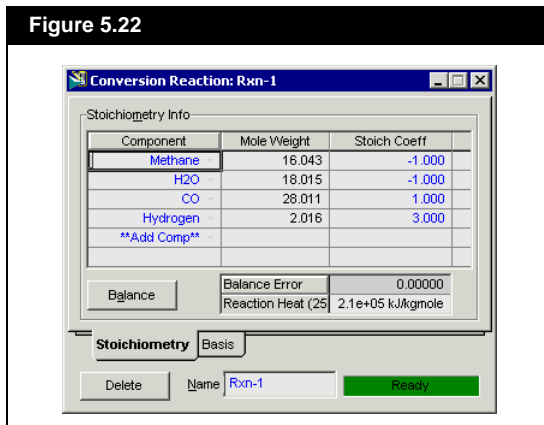

- On the Reaction Package view, click the **New Set** button to create a Reaction Set. The Reaction Set view appears.

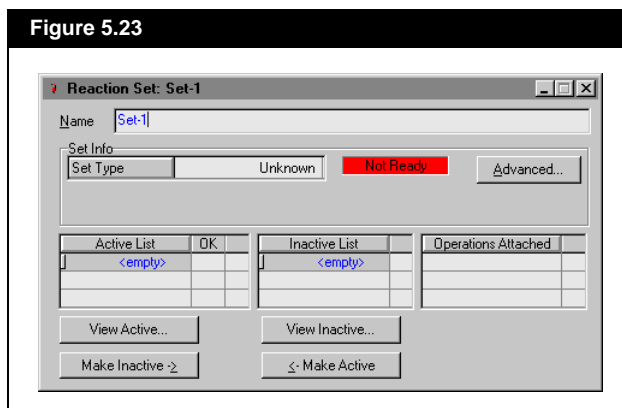

- If desired, change the Name of the Reaction Set to better identify it.
- To attach the newly created reaction to the Reaction Set, place the cursor in the **<empty>** cell of the Active List column. Open the drop-down list in the cell and select a reaction. The reaction becomes attached to the Reaction Set, as indicated by the activated checkbox in the OK column.
- Click the **Close** button on the Reaction Set view.
- In the **Available Reaction Sets** group of the Reaction Package view, highlight the name of the newly created Reaction Set. Notice that the attached reaction is listed in the **Associated Reactions** group.
- Click the **Add Set** button to make the Reaction Set, and thus the Reaction, available to unit operations in the flowsheet. The new Reaction Set is displayed in the **Current Reaction Sets** group.

5.6 Reactions - Example

The following procedure demonstrates the minimum steps required for:

- The addition of components to the Reaction Manager.
- The creation of a reaction.
- The addition of the reaction to a reaction set.
- The attachment of the reaction set to a fluid package.

5.6.1 Add Components to the Reaction Manager

Refer to [Section 2.4 - HYSYS Fluid Package Property View](#) for details on installing a fluid package.

For this example, it is assumed that a New Case is created and a fluid package is installed.

1. Within the fluid package, the Peng Robinson property package is selected.
2. Within the component list, the following set of components are selected: H₂O, CO, CO₂, H₂, O₂, and CH₄.
3. Go to the **Reactions** tab of the Simulation Basis Manager. The selected components are present in the Rxn Components group.

5.6.2 Create a Reaction

Refer to [Section 5.3 - Reactions](#) for information concerning reaction types and the addition of reactions.

1. To install a reaction, click the **Add Rxn** button.
2. From the Reactions view, highlight the **Conversion** reaction type and click the **Add Reaction** button. The Conversion Reaction property view appears.
3. On the **Stoichiometry** tab, select the first row of the **Component** column in the Stoichiometry Info table.
4. Select **Methane** from the drop-down list. The Mole Weight column automatically provides the molar weight of methane.
5. In the **Stoich Coeff** field, enter -3 (i.e., 3 moles of methane is consumed).

- Now define the rest of the Stoichiometry tab as shown in the figure below and click the **Balance** button.

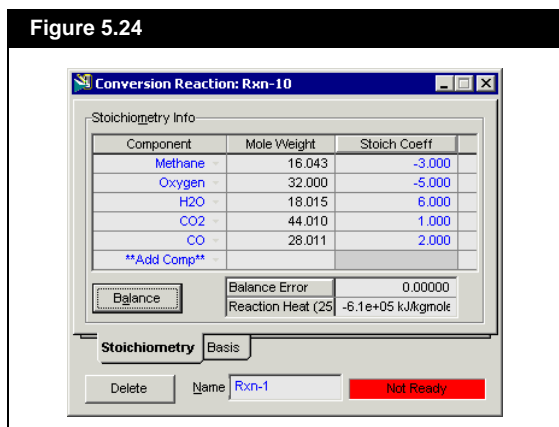

- Go to the **Basis** tab and set **Methane** as the Base Component and Conversion to **60%**. The status bar at the bottom of the property view now shows a **Ready** status. Close the property view.

5.6.3 Add the Reaction to a Reaction Set

Refer to [Section 5.4 - Reaction Sets](#) for details concerning Reaction Sets.

By default, the Global Rxn Set is present within the Reaction Sets group when you first display the Reaction Manager. However, for this procedure, a new Reaction Set is created:

- Click the **Add Set** button. HYSYS provides the name **Set-1** and opens the Reaction Set property view.
- To attach the newly created Reaction to the Reaction Set, place the cursor in the **<empty>** cell under Active List.

- Open the drop-down list and select the name of the Reaction (Rxn-1). The Set Type corresponds to the type of Reaction which you have added to the Reaction Set. The status is now **Ready**.

Figure 5.25

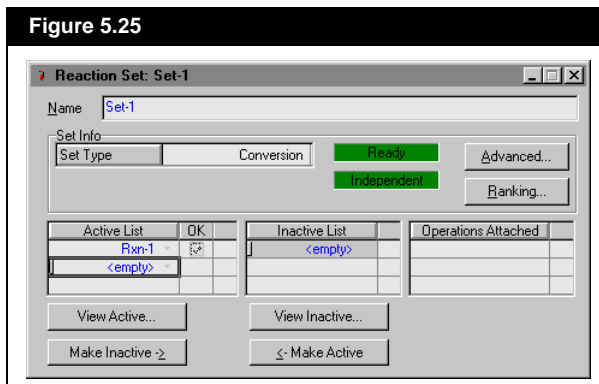

- Close the view to return to the Reaction Manager.

5.6.4 Attach the Reaction Set to a Fluid Package

- To attach the reaction set to the fluid package, highlight **Set-1** in the Reaction Sets group and click the **Add to FP** button. When a Reaction Set is attached to a Fluid Package, it becomes available to unit operations within the Flowsheet using that particular Fluid Package.
- The Add 'Set-1' view appears, from which you highlight a fluid package and click the **Add Set to Fluid Package** button.
- Close the view. Notice that the name of the fluid package appears in the Assoc. Fluid Pkgs group when the **Reaction Set** is highlighted in the Reaction Sets group.

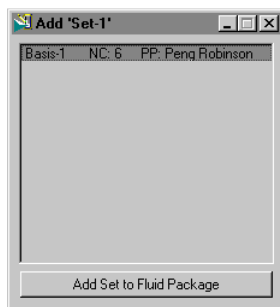

6 Component Maps

6.1 Introduction	2
6.2 Component Maps Tab	2
6.2.1 Component Mapping Group	3
6.2.2 Collections Group.....	3
6.2.3 Maps for Collection Group.....	3
6.3 Component Map Property View	4

6.1 Introduction

On the Component Maps tab of the Simulation Basis Manager, you can map fluid component composition across fluid package boundaries. Composition values for individual components from one fluid package can be mapped to a different component in an alternate fluid package. This is usually done when dealing with hypothetical oil components.

Two previously defined fluid packages are required to perform a component mapping which is defined as a collection. One fluid package becomes the target component set and the other becomes the *source* component set. Mapping is performed using a matrix of source and target components. The transfer basis can be performed on a mole, mass, or liquid volume basis.

6.2 Component Maps Tab

The Component Maps tab of the Simulation Basis Manager is shown below.

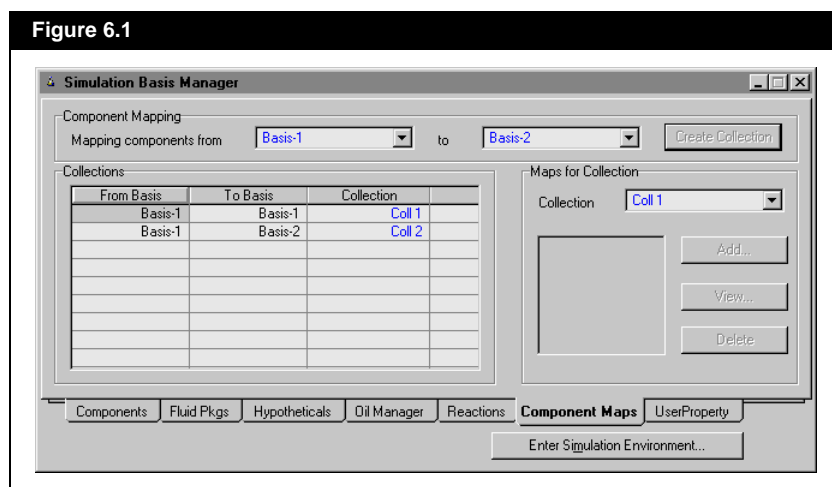

6.2.1 Component Mapping Group

The Component Mapping group defines the source and target fluid packages to be mapped. Once two distinct fluid packages are selected, the Create Collection button creates a collection in the Collections group.

6.2.2 Collections Group

The Collections group lists all the component mapping collections currently available. You can change the collection name by selecting the name you want to edit and typing in the new name.

6.2.3 Maps for Collection Group

The Maps for Collection group allows you to manage your Component Maps for each collection. The Collection drop-down list lets you select the collection maps that you want to add, edit, or delete. A default collection map is added to this list and cannot be deleted. To add a Component Map based on the currently selected collection, click the Add button. To view a Component Map, select it from the list and click the View button. Both the Add and View buttons open the Component Map Property view. To delete a Component Map, select the map from the list and click the Delete button.

6.3 Component Map Property View

Each time a Component Map is created or viewed via the Component Maps tab of the Simulation Basis Manager, the Component Map property view opens as shown below:

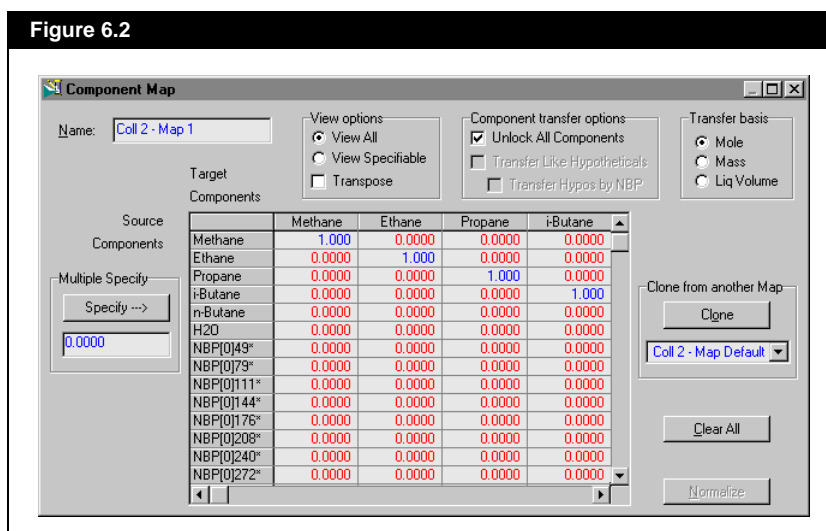

The Component Map property view allows you to map the source components to the target components in the component matrix. Within the matrix, you can map all Specifiable (in red) component mapping values. The following table describes all of the options found in this view.

Object	Description
Name	Displays the name of the component map. The name can be modified within the cell.
View Options	The View Options group provides you with three options in which to view the component matrix. <ul style="list-style-type: none"> • View All. Displays all of the source and target components in the matrix. • View Specifiable. Displays only the components that require values. • Transpose. Transposes the component matrix.

Object	Description
Component Transfer Options	The Component Transfer Options group provides two options. <ul style="list-style-type: none">• Unlock all Components. Unlocks all of the component values, allowing you to specify your own values.• Transfer Like Hypotheticals. Automatically maps like hypotheticals.• Transfer Hypos by NBP. Automatically maps hypos by NBP. This option is available when you checked the Transfer Like Hypotheticals checkbox.
Transfer Basis	The Transfer Basis group provides three options that allow you to define the composition mapping basis: <ul style="list-style-type: none">• Mole• Mass• Liq Volume
Multiple Specify	Allows you to specify a value to one or more components at a time.
Clone from another Map	Allows you to import values into the mapping matrix from another map.
Clear All	Removes all of the user defined information from the matrix.
Normalize	Normalizes the mapping matrix.

7 User Properties

7.1 Introduction	2
7.2 User Property Tab	3
7.2.1 Adding a User Property	4
7.3 User Property View	4
7.3.1 Data Tab	5
7.3.2 Notes Tab	9

7.1 Introduction

On the User Property tab of the Simulation Basis Manager, you can create an unlimited number of user properties for use in the Build Environment. A User Property is any property that can be defined and subsequently calculated on the basis of composition.

When User properties are specified, they are used globally throughout the case. You can supply a User Property value for each component. User properties can be modified for a specific component, fluid package, or stream using the property editor.

Refer to [Edit Properties](#) from [Section 1.2.3 - Manipulating the Selected Components List](#) for more information on the property editor.

Specifying a User Property is similar to supplying a value at the component level in that it is globally available throughout the case, unless it is specified otherwise. It is the initial user property value for the component in the master component list. By selecting the mixing basis and mixing equation, the total User Property can be calculated.

After a User Property is defined, HYSYS is able to calculate the value of the property for any flowsheet stream through the User Property utility. User Properties can also be set as Column specifications.

7.2 User Property Tab

The User Property tab of the Simulation Basis Manager is shown below:

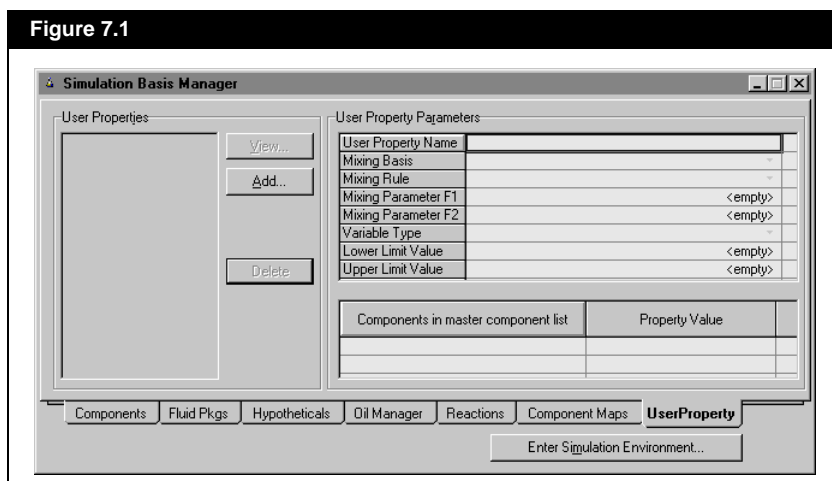

The available User Properties are listed in the User Properties group. The following User Property manipulation buttons are available:

A User Property can also be added or viewed through the Oil Characterization - User Property tab.

Button	Description
View	Edit the currently highlighted User Property.
Add	Create a new User Property.
Delete	Erase the currently highlighted User Property. HYSYS will not prompt for confirmation when deleting a User Property, so be careful when you are using this command.

Refer to [Chapter 7.3 - User Property View](#) for descriptions of the User Property Parameters.

In the User Property Parameters group, all information pertaining to the highlighted property in the User Property group is displayed. You can edit the User Property parameters directly on the Simulation Basis view or click on the View button for the User Property view.

7.2.1 Adding a User Property

To add a user property, follow the steps below:

1. On the User Property tab of the Simulation Basis Manager, click the **Add** button. The User Property view is displayed.
2. Provide a descriptive Name for the user property on Simulation Basis view.
3. In the User Property Parameters group, select a **Mixing Basis** using the drop-down list within the cell.
4. Select a **Mixing Rule**.
5. You can modify the two Mixing Parameters (F1 and F2) to more accurately reflect your property formula.
6. Select a Unit Type from the filtered drop-down list.
7. Input initial property values for each component.

7.3 User Property View

Each time a User Property is created through the User Property tab of the Simulation Basis Manager, the User Property view is displayed. The User Property view has two tabs, the Data tab and the Notes tab. All information regarding the calculation of the User Property is specified on the Data tab.

7.3.1 Data Tab

On the Data tab, the Basic user prop definition, and the Initial user property value groups are displayed.

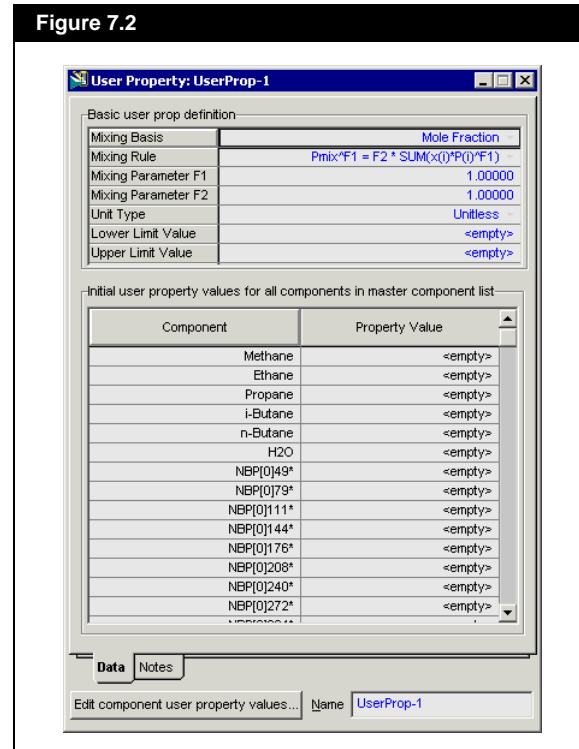

Basic User Property Definition Group

The following options are available for Process type properties:

Parameter	Description
Mixing Basis	<p>You have the following options: Mole Fraction, Mass Fraction, Liquid Volume Fraction, Mole Flow, Mass Flow, and Liquid Volume Flow.</p> <p>All calculations are performed using compositions in HYSYS internal units. If you have specified a flow basis (molar, mass or liquid volume flow), HYSYS uses the composition as calculated in internal units for that basis.</p> <p>For example, a User Property with a Mixing Basis specified as molar flow is always calculated using compositions in kg mole/s, regardless of what the current default units are.</p>
Mixing Rule	<p>Select from one of three mixing rules:</p> $(P_{mix})^{f1} = f2 \sum_{i=1}^N (x(i)P(i)^{f1}) \quad (7.1)$ $(P_{mix})^{f1} = f2 \sum_{i=1}^N (x(i) \ln(P(i))^{f1}) \quad (7.2)$ $Index = \sum_{i=1}^N x(i)(f1 \cdot P(i) + 10^{f2 \cdot P(i)}) \quad (7.3)$ <p>where:</p> <p>P_{mix} = total user property value</p> <p>$P(i)$ = input property value for component</p> <p>$x(i)$ = component fraction or flow, depending on the chosen Mixing Basis</p> <p>Index = blended (total) index value</p> <p>$f1$ and $f2$ are specified constants</p>
Mixing Parameters	<p>The mixing parameters $f1$ and $f2$ are 1.00 by default. You may supply any value for these parameters.</p>
Unit Type	<p>This option allows you to select the variable type for the user property.</p> <p>For example, if you have a temperature user property, select temperature in the unit type using the drop-down list.</p>

Mixing Rules

As listed previously, there are three mixing rules available when you are defining a user property. [Equation \(7.1\)](#) and [Equation \(7.2\)](#) are relatively straightforward. The index mixing rule, [Equation \(7.3\)](#), is slightly more complex.

With the index mixing rule, HYSYS allows you to combine properties that are not inherently linear. A property is made linear through the use of the index equation.

The form of your index equation must resemble the HYSYS index equation such that you can supply the $f1$ and $f2$ parameters. Some common properties which can make use of the Index equation include R.O.N., Pour Point and Viscosity.

[Equation \(7.3\)](#) can be simplified into the following equations:

$$Index_i = f1 \cdot P(i) + 10^{f2 \cdot P(i)} \quad (7.4)$$

$$Index = \sum_{i=1}^N x(i) \cdot Index_i \quad (7.5)$$

$$Index = f1 \cdot P + 10^{f2 \cdot P} \quad (7.6)$$

You supply the individual component properties (P_i) and the index equation parameters (i.e., $f1$ and $f2$). Using [Equation \(7.4\)](#), HYSYS calculates an individual index value for each supplied property value. The sum of the index values, which is the blended index value, is then calculated using the Mixing Basis you have selected ([Equation \(7.5\)](#)).

The blended index value is used in an iterative calculation to produce the blended property value (P in [Equation \(7.6\)](#)). The blended property value is the value which will be displayed in the user property utility.

Initial User Property Values for All Components Group

User Property values can be assigned to hypocomponent during the characterization of an oil. Refer to [Section 7.2.1 - Adding a User Property](#) for more information.

Refer to [Chapter 14 - Utilities](#) of the **Operations Guide** for more information on the User Property utility.

Refer to [Chapter 8 - Column](#) of the **Operations Guide** for information on the User Property specification.

The purpose of this view is to instruct HYSYS how the User Property should be initialized throughout the case. Whenever the value of a User Property is requested by the User Property utility or by the column specification, HYSYS uses the composition in the specified basis, and calculate the User Property value using your mixing rule and parameters.

The values for pure components are always used for the property and are not overwritten by the synthesis. The values for hypocomponents are only used if the synthesis of the property can not be achieved. For example, if there are insufficient number of data points. To specify a Property Value, click on the Edit component user property values button.

Edit Component User Property Values

This view allows you to edit initial user property values for components in the master component list.

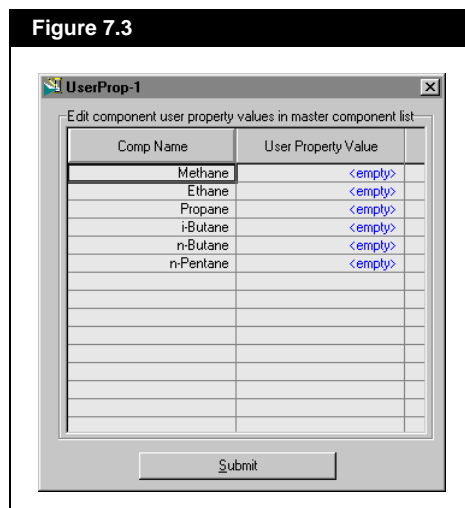

Once property values are entered or edited, click the Submit button which allows all values to be modified at one time. The changes are reflected on the User Property view for each component.

7.3.2 Notes Tab

HYSYS provides a tab where you can enter a description of the User Properties for your own future reference.

A Property Methods & Calculations

A.1 Introduction	3
A.2 Selecting Property Methods.....	4
A.3 Property Methods.....	9
A.3.1 Equations of State.....	9
A.3.2 Activity Models	16
A.3.3 Activity Model Vapour Phase Options	35
A.3.4 Semi-Empirical Methods	37
A.3.5 Vapour Pressure Property Packages	38
A.3.6 Miscellaneous - Special Application Methods	41
A.4 Enthalpy & Entropy Departure Calculations	45
A.4.1 Equations of State.....	45
A.4.2 Activity Models	47
A.4.3 Lee-Kesler Option	49
A.5 Physical & Transport Properties.....	51
A.5.1 Liquid Density	52
A.5.2 Vapour Density.....	53
A.5.3 Viscosity	53
A.5.4 Liquid Phase Mixing Rules for Viscosity	55
A.5.5 Thermal Conductivity	56
A.5.6 Surface Tension	58
A.5.7 Heat Capacity	59
A.6 Volumetric Flow Rate Calculations	59
A.6.1 Available Flow Rates	60
A.6.2 Liquid & Vapour Density Basis	60
A.6.3 Formulation of Flow Rate Calculations	62
A.6.4 Volumetric Flow Rates as Specifications	64

A.7 Flash Calculations	65
A.7.1 T-P Flash Calculation	66
A.7.2 Vapour Fraction Flash.....	66
A.7.3 Enthalpy Flash.....	68
A.7.4 Entropy Flash	68
A.7.5 Electrolyte Flash	68
A.7.6 Handling of Water	69
A.7.7 Supercritical Handling.....	71
A.7.8 Solids.....	72
A.7.9 Stream Information	73
A.8 References	75

A.1 Introduction

This appendix is organized such that the detailed calculations that occur within the Simulation Basis Manager and within the Flowsheet are explained in a logical manner.

- In the first section, an overview of property method selection is presented. Various process systems and their recommended property methods are listed.
- Detailed information is provided concerning each individual property method available in HYSYS. This section is further subdivided into equations of state, activity models, Chao-Seader based semi-empirical methods, vapour pressure models, and miscellaneous methods.
- Following the detailed property method discussion is the section concerning enthalpy and entropy departure calculations. The enthalpy and entropy options available within HYSYS are largely dependent upon your choice of a property method.
- The physical and transport properties are covered in detail. The methods used by HYSYS in calculating liquid density, vapour density, viscosity, thermal conductivity, and surface tension are listed.
- HYSYS handles volume flow calculations in a unique way. To highlight the methods involved in calculating volumes, a separate section is provided.
- The next section ties all of the previous information together. Within HYSYS, the Flash calculation uses the equations of the selected property method, as well as the physical and transport property functions to determine all property values for Flowsheet streams. After a flash calculation is performed on an object, all of its thermodynamic, physical and transport properties are defined. The flash calculation in HYSYS does not require initial guesses or the specification of flash type to assist in its convergence.
- A list of References is included at the end of the Appendix.

A.2 Selecting Property Methods

The property packages available in HYSYS allow you to predict properties of mixtures ranging from well defined light hydrocarbon systems to complex oil mixtures and highly non-ideal (non-electrolyte) chemical systems. HYSYS provides enhanced equations of state (PR and PRSV) for rigorous treatment of hydrocarbon systems; semi-empirical and vapour pressure models for the heavier hydrocarbon systems; steam correlations for accurate steam property predictions; and activity coefficient models for chemical systems. All of these equations have their own inherent limitations and you are encouraged to become more familiar with the application of each equation.

The following table lists some typical systems and recommended correlations. However, when in doubt of the accuracy or application of one of the property packages, contact Hyprotech to receive additional validation material or our best estimate of its accuracy.

Type of System	Recommended Property Method
TEG Dehydration	PR
Sour Water	PR, Sour PR
Cryogenic Gas Processing	PR, PRSV
Air Separation	PR, PRSV
Atm Crude Towers	PR, PR Options, GS
Vacuum Towers	PR, PR Options, GS (<10 mm Hg), Braun K10, Esso K
Ethylene Towers	Lee Kesler Plocker
High H ₂ Systems	PR, ZJ or GS (see T/P limits)
Reservoir Systems	PR, PR Options
Steam Systems	Steam Package, CS or GS
Hydrate Inhibition	PR
Chemical systems	Activity Models, PRSV
HF Alkylation	PRSV, NRTL (Contact Hyprotech)
TEG Dehydration with Aromatics	PR (Contact Hyprotech)
Hydrocarbon systems where H ₂ O solubility in HC is important	Kabadi Danner
Systems with select gases and light hydrocarbons	MBWR

For oil, gas and petrochemical applications, the Peng-Robinson EOS (PR) is generally the recommended property package. Hyprotech's enhancements to this equation of state enable it to be accurate for a variety of systems over a wide range of conditions. It rigorously solves any single, two-phase or three-phase system with a high degree of efficiency and reliability, and is applicable over a wide range of conditions, as shown in the following table.

Method	Temp (°F)	Temp (°C)	Pressure (psia)	Pressure (kPa)
PR	> -456	> -271	< 15,000	< 100,000
SRK	> -225	> -143	< 5,000	< 35,000

The range of applicability in many cases is more indicative of the availability of good data rather than on the actual limitations.

The PR equation of state is enhanced to yield accurate phase equilibrium calculations for systems ranging from low temperature cryogenic systems to high temperature, high pressure reservoir systems. The same equation of state satisfactorily predicts component distributions for heavy oil systems, aqueous glycol and CH₃OH systems, and acid gas/sour water systems, although specific sour water models (Sour PR and Sour SRK) are available for more specialized treatment.

Our high recommendation for the PR equation of state is largely due to the preferential attention that is given to it by Hyprotech. Although the Soave-Redlich-Kwong (SRK) equation also provides comparable results to the PR in many cases, it is known that its range of application is significantly limited and it is not as reliable for non-ideal systems. For example, it should not be used for systems with CH₃OH or glycols.

As an alternate, the PRSV equation of state should also be considered. It can handle the same systems as the PR equation with equivalent, or better accuracy, plus it is more suitable for handling moderately non-ideal systems.

The advantage of the PRSV equation is that not only does it have the potential to more accurately predict the phase behaviour of hydrocarbon systems, particularly for systems composed of dissimilar components, but it can also be extended to handle non-ideal systems with accuracies that rival traditional activity coefficient models. The only compromise is increased computational time and the additional interaction parameter that is required for the equation.

The PR and PRSV equations of state perform rigorous three-phase flash calculations for aqueous systems containing H_2O , CH_3OH or glycols, as well as systems containing other hydrocarbons or non-hydrocarbons in the second liquid phase. For SRK, H_2O is the only component that initiates an aqueous phase. The Chao-Seader (CS) and Grayson-Streed (GS) packages can also be used for three-phase flashes, but are restricted to the use of pure H_2O for the second liquid phase.

The PR can also be used for crude systems, which have traditionally been modeled with dual model thermodynamic packages (an activity model representing the liquid phase behaviour, and an equation of state or the ideal gas law for the vapour phase properties). These earlier models are suspect for systems with large amounts of light ends or when approaching critical regions. Also, the dual model system leads to internal inconsistencies. The proprietary enhancements to the PR and SRK methods allow these EOSs to correctly represent vacuum conditions and heavy components (a problem with traditional EOS methods), as well as handle the light ends and high-pressure systems.

Activity Models, which handle highly non-ideal systems, are much more empirical in nature when compared to the property predictions in the hydrocarbon industry. Polar or non-ideal chemical systems are traditionally handled using dual model approaches. In this type of approach, an equation of state is used for predicting the vapour fugacity coefficients and an activity coefficient model is used for the liquid phase. Since the experimental data for activity model parameters are fitted for a specific range, these property methods cannot be used as reliably for generalized application.

The CS and GS methods, though limited in scope, may be preferred in some instances. For example, they are recommended for problems containing mainly liquid or vapour H_2O because they include special correlations that accurately represent the steam tables. The Chao Seader method can be used for light hydrocarbon mixtures, if desired. The Grayson-Streed correlation is recommended for use with systems having a high concentration of H_2 because of the special treatment given H_2 in the development of the model. This correlation may also be slightly more accurate in the simulation of vacuum towers.

The Vapour Pressure K models, Antoine, BraunK10 and EssoK models, are designed to handle heavier hydrocarbon systems at lower pressures. These equations are traditionally applied for heavier hydrocarbon fractionation systems and consequently provide a good means of comparison against rigorous models. They should not be considered for VLE predictions for systems operating at high pressures or systems with significant quantities of light hydrocarbons.

The Property Package methods in HYSYS are divided into basic categories, as shown in the following table. With each of the property methods listed are the available methods of VLE and Enthalpy/Entropy calculation.

Please refer to [Section A.4 - Enthalpy & Entropy Departure Calculations](#), for a description of Enthalpy and Entropy calculations.

Property Method	VLE Calculation	Enthalpy/Entropy Calculation
Equations of State		
PR	PR	PR
PR LK ENTH	PR	Lee-Kesler
SRK	SRK	SRK
SRK LK ENTH	SRK	Lee-Kesler
Kabadi Danner	Kabadi Danner	SRK
Lee Kesler Plocker	Lee Kesler Plocker	Lee Kesler
PRSV	PRSV	PRSV
PRSV LK	PRSV	Lee-Kesler
Sour PR	PR & API-Sour	PR
SOUR SRK	SRK & API-Sour	SRK
Zudkevitch-Joffee	Zudkevitch-Joffee	Lee-Kesler
Activity Models		
Liquid		
Chien Null	Chien Null	Cavett
Extended and General NRTL	NRTL	Cavett
Margules	Margules	Cavett
NRTL	NRTL	Cavett
UNIQUAC	UNIQUAC	Cavett
van Laar	van Laar	Cavett
Wilson	Wilson	Cavett
Vapour		
Ideal Gas	Ideal	Ideal Gas

Property Method	VLE Calculation	Enthalpy/Entropy Calculation
RK	RK	RK
Virial	Virial	Virial
Peng Robinson	Peng Robinson	Peng Robinson
SRK	SRK	SRK
Semi-Empirical Models		
Chao-Seader	CS-RK	Lee-Kesler
Grayson-Streed	GS-RK	Lee-Kesler
Vapour Pressure Models		
Mod Antoine	Mod Antoine-Ideal Gas	Lee-Kesler
Braun K10	Braun K10-Ideal Gas	Lee-Kesler
Esso K	Esso-Ideal Gas	Lee-Kesler
Miscellaneous - Special Application Methods		
Amines	Mod Kent Eisenberg (L), PR (V)	Curve Fit
Steam Packages		
ASME Steam	ASME Steam Tables	ASME Steam Tables
NBS Steam	NBS/NRC Steam Tables	NBS/NRC Steam Tables
MBWR	Modified BWR	Modified BWR

A.3 Property Methods

Details of each individual property method available in HYSYS are provided in this section, including equations of state, activity models, Chao-Seader based empirical methods, vapour pressure models, and miscellaneous methods.

A.3.1 Equations of State

It is important to note that the properties predicted by HYSYS' PR and SRK equations of state do not necessarily agree with those predicted by the PR and SRK of other commercial simulators.

HYSYS currently offers the enhanced Peng-Robinson¹ (PR), and Soave-Redlich-Kwong² (SRK) equations of state. In addition, HYSYS offers several methods which are modifications of these property packages, including PRSV, Zudkevitch Joffee (ZJ) and Kabadi Danner (KD). Lee Kesler Plocker³ (LKP) is an adaptation of the Lee Kesler equation for mixtures, which itself was modified from the BWR equation. Of these, the Peng-Robinson equation of state supports the widest range of operating conditions and the greatest variety of systems. The Peng-Robinson and Soave-Redlich-Kwong equations of state (EOS) generate all required equilibrium and thermodynamic properties directly. Although the forms of these EOS methods are common with other commercial simulators, they have been significantly enhanced by Hyprotech to extend their range of applicability.

The Peng-Robinson property package options are PR, Sour PR, and PRSV. Soave-Redlich-Kwong equation of state options are the SRK, Sour SRK, KD and ZJ.

PR & SRK

The PR or SRK EOS should not be used for non-ideal chemicals such as alcohols, acids or other components. They are more accurately handled by the Activity Models (highly non-ideal) or the PRSV EOS (moderately non-ideal).

The PR and SRK packages contain enhanced binary interaction parameters for all library hydrocarbon-hydrocarbon pairs (a combination of fitted and generated interaction parameters), as well as for most hydrocarbon-nonhydrocarbon binaries.

For non-library or hydrocarbon hypocomponent, HC-HC interaction parameters are generated automatically by HYSYS for improved VLE property predictions.

The PR equation of state applies a functionality to some specific component-component interaction parameters. Key components receiving special treatment include He, H₂, N₂, CO₂, H₂S, H₂O, CH₃OH, EG and TEG. For further information on application of equations of state for specific components, contact Hyprotech.

The following page provides a comparison of the formulations used in HYSYS for the PR and SRK equations of state.

	Soave Redlich Kwong	Peng Robinson
	$P = \frac{RT}{V-b} - \frac{a}{V(V+b)}$ $Z^3 - Z^2 + (A - B - B^2)Z - AB = 0$	$P = \frac{RT}{V-b} - \frac{a}{V(V+b) + b(V-b)}$ $Z^3 - (1-B)Z^2 + (A - 2B - 3B^2)Z - (AB - B^2 - B^3) = 0$
where		
$b =$	$\sum_{i=1}^N x_i b_i$	$\sum_{i=1}^N x_i b_i$
$b_i =$	$0.08664 \frac{RT_{ci}}{P_{ci}}$	$0.077796 \frac{RT_{ci}}{P_{ci}}$
$a =$	$\sum_{i=1}^N \sum_{j=1}^N x_i x_j (a_i a_j)^{0.5} (1 - k_{ij})$	$\sum_{i=1}^N \sum_{j=1}^N x_i x_j (a_i a_j)^{0.5} (1 - k_{ij})$
$a_i =$	$a_{ci} \alpha_i$	$a_{ci} \alpha_i$
$a_{ci} =$	$0.42747 \frac{(RT_{ci})^2}{P_{ci}}$	$0.457235 \frac{(RT_{ci})^2}{P_{ci}}$
$\alpha_i^{0.5} =$	$1 + m_i (1 - T_{ri}^{0.5})$	$1 + m_i (1 - T_{ri}^{0.5})$
$m_i =$	$0.48 + 1.574 \omega_i - 0.176 \omega_i^2$	$0.37464 + 1.54226 \omega_i - 0.26992 \omega_i^2$ <p>When an acentric factor > 0.49 is present HYSYS uses following corrected form:</p> $0.379642 + (1.48503 - (0.164423 - 1.016666 \omega_i) \omega_i) \omega_i$
$A =$	$\frac{aP}{(RT)^2}$	$\frac{aP}{(RT)^2}$
$B =$	$\frac{bP}{RT}$	$\frac{bP}{RT}$

Kabadi Danner

This KD⁴ model is a modification of the original SRK equation of State, enhanced to improve the vapour-liquid-liquid equilibria calculations for H₂O-hydrocarbon systems, particularly in the dilute regions.

The model is an improvement over previous attempts which were limited in the region of validity. The modification is based on an asymmetric mixing rule, whereby the interaction in the water phase (with its strong H₂ bonding) is calculated based on both the interaction between the hydrocarbons and the H₂O, and on the perturbation by hydrocarbon on the H₂O-H₂O interaction (due to its structure).

Lee Kesler Plöcker Equation

The Lee Kesler Plöcker equation does not use the COSTALD correlation in computing liquid density. This may result in differences when comparing results between equation of states.

The Lee Kesler Plöcker equation is an accurate general method for non-polar substances and mixtures. Plöcker et al.³ applied the Lee Kesler equation to mixtures, which itself was modified from the BWR equation.

$$z = z^{(o)} + \frac{\omega}{\omega^{(r)}}(z^{(r)} - z^{(o)}) \quad (\text{A.1})$$

The compressibility factors are determined as follows:

$$z = \frac{pv}{RT} = \frac{p_r v_r}{T_r} = z(T_r, v_r, A_k) \quad (\text{A.2})$$

$$z = 1 + \frac{B}{v_r} + \frac{C}{v_r^2} + \frac{D}{v_r^3} + \frac{C_4}{T_r^3 v_r^2} \left[\beta + \frac{\gamma}{v_r} \right] \exp \left[\frac{-\gamma}{v_r^2} \right] \quad (\text{A.3})$$

where:

$$\begin{aligned}
 v_r &= \frac{p_c v}{RT_c} & B &= b_1 - \frac{b_2}{T_r} - \frac{b_3}{T_r^2} - \frac{b_4}{T_r^3} \\
 C &= c_1 - \frac{c_2}{T_r} + \frac{c_3}{T_r^2} & D &= d_1 - \frac{d_2}{T_r} \\
 \omega^{(o)} &= 0 & \omega^{(r)} &= 0.3978
 \end{aligned}$$

Mixing rules for pseudocritical properties are as follows:

$$T_{cm} = \left(\frac{1}{v_{cm}^{\eta}} \right) \sum_i \sum_j x_i x_j v_{c_{ij}} \quad (\text{A.4})$$

$$T_{c_{ij}} = (T_{c_i} T_{c_j})^{1/2} \quad T_{c_{ii}} = T_{c_i} \quad T_{c_{jj}} = T_{c_j}$$

$$v_{c_m} = \sum_i \sum_j x_i x_j v_{c_{ij}} \quad v_{c_{ij}} = \frac{1}{8} (v_{c_i}^{1/3} + v_{c_j}^{1/3})^3$$

$$v_{c_i} = z_{c_i} \frac{RT_{c_i}}{p_{c_i}} \quad z_{c_i} = 0.2905 - 0.085 \omega_i$$

$$p_{c_m} = z_{c_m} \frac{RT_{c_m}}{v_{c_m}} \quad z_{c_m} = 0.2905 - 0.085 \omega_m$$

$$\omega_m = \sum_i x_i \omega_i$$

Peng-Robinson Stryjek-Vera

The Peng-Robinson Stryjek-Vera (PRSV) equation of state is a two-fold modification of the PR equation of state that extends the application of the original PR method for moderately non-ideal systems. It is shown to match vapour pressures curves of pure components and mixtures more accurately than the PR method, especially at low vapour pressures.

It is successfully extended to handle non-ideal systems giving results as good as those obtained using excess Gibbs energy functions like the Wilson, NRTL or UNIQUAC equations.

One of the proposed modifications to the PR equation of state by Stryjek and Vera was an expanded alpha, " α ", term that became a function of acentricity and an empirical parameter, κ_i , used for fitting pure component vapour pressures.

$$\begin{aligned}\alpha_i &= [1 + \kappa_i(1 - T_r^{0.5})]^2 \\ \kappa_i &= \kappa_{0i} + \kappa_{1i}(1 + T_r^{0.5})(0.7 - T_r^{0.5}) \\ \kappa_{0i} &= 0.378893 + 1.4897153\omega_i - 0.17131848\omega_i^2 + 0.0196554\omega_i^3\end{aligned}\quad (\text{A.5})$$

where: κ_{1i} = characteristic pure component parameter

ω_i = acentric factor

The adjustable κ_{1i} term allows for a much closer fit of the pure component vapour pressure curves. This term is regressed against the pure component vapour pressure for all components in HYSYS' library.

For hypocomponent that are generated to represent oil fractions, HYSYS automatically regresses the κ_{1i} term for each hypocomponent against the Lee-Kesler vapour pressure curves. For individual user-added hypothetical components, κ_{1i} terms can either be entered or they are automatically regressed against the Lee-Kesler, Gomez-Thodos or Reidel correlations.

The second modification consists of a new set of mixing rules for mixtures. Conventional mixing rules are used for the volume and energy parameters in mixtures, but the mixing rule for the cross term, a_{ij} , is modified to adopt a composition dependent form. Although two different mixing rules were proposed in the original paper, HYSYS has incorporated only the Margules expression for the cross term.

$$a_{ij} = (a_{ii}a_{jj})^{0.5}(1.0 - x_i k_{ij} - x_j k_{ji}) \quad (\text{A.6})$$

where: $k_{ij} \neq k_{ji}$

If $k_{ij} = k_{ji}$, the mixing rules reduce to the standard PR equation of state.

Different values can be entered for each of the binary interaction parameters.

Although only a limited number of binary pairs are regressed for this equation, our limited experience suggests that the PRSV can be used to model moderately non-ideal systems such as H₂O-alcohol systems, some hydrocarbon-alcohol systems. You can also model hydrocarbon systems with improved accuracy. Also, due to PRSV's better vapour pressure predictions, improved heat of vaporization predictions should be expected.

Sour Water Options

The Sour option is available for both the PR and SRK equations of state. The Sour PR option combines the PR equation of state and Wilson's API-Sour Model for handling sour water systems, while Sour SRK utilizes the SRK equation of state with the Wilson model.

The Sour options use the appropriate equation of state for calculating the fugacities of the vapour and liquid hydrocarbon phases as well as the enthalpy for all three phases. The K-values for the aqueous phase are calculated using Wilson's API-Sour method. This option uses Wilson's model to account for the ionization of the H₂S, CO₂ and NH₃ in the aqueous water phase. The aqueous model employs a modification of Van Krevelen's original model with many of the key limitations removed. More details of the model are available in the original API publication 955 titled "A New Correlation of NH₃, CO₂, and H₂S Volatility Data from Aqueous Sour Water Systems".

It is important to note that because the method performs an ion balance for each K-value calculation, the flash calculation is much slower than the standard EOS.

The original model is applicable for temperatures between 20°C (68°F) and 140°C (285°F), and pressures up to 50 psi. Use of either the PR or SRK equation of state to correct vapour phase non idealities extends this range, but due to lack of experimental data, exact ranges cannot be specified. The acceptable pressure ranges for HYSYS' model vary depending upon the concentration of the acid gases and H₂O. The method performs well when the H₂O partial pressure is below 100 psi.

This option may be applied to sour water strippers, hydrotreater loops, crude columns or any process containing hydrocarbons, acid gases and H₂O. If the aqueous phase is not present, the method produces identical results to the EOS, (PR or SRK depending on which option you have chosen).

Zudkevitch Joffee

The Zudkevitch Joffee model is a modification of the Redlich Kwong equation of state. This model is enhanced for better prediction of vapour liquid equilibria for hydrocarbon systems, and systems containing H₂. The major advantage of this model over the previous version of the RK equation is the improved capability of predicting pure component equilibria, and the simplification of the method for determining the required coefficients for the equation.

Enthalpy calculations for this model are performed using the Lee Kesler model.

EOS Enthalpy Calculation

The Lee-Kesler enthalpies may be slightly more accurate for heavy hydrocarbon systems, but require more computer resources because a separate model must be solved.

With any the Equation of State options except ZJ and LKP, you can specify whether the Enthalpy is calculated by either the Equation of State method or the Lee Kesler method. The ZJ and LKP must use the Lee Kesler method in Enthalpy calculations. Selection of an enthalpy method is done by selecting radio buttons in the Enthalpy Method group.

Figure A.1

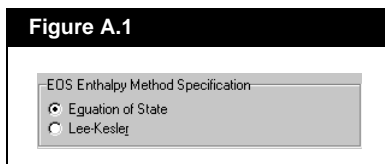

Selecting the Lee Kesler Enthalpy option results in a combined property package employing the appropriate equation of state (either PR or SRK) for vapour-liquid equilibrium calculations and the Lee-Kesler equation for calculation of enthalpies and entropies (for differences between EOS and LK methods, refer to the [Section A.4 - Enthalpy & Entropy Departure Calculations](#)).

The LK method yields comparable results to HYSYS' standard equations of state and has identical ranges of applicability. As such, this option with PR has a slightly greater range of applicability than with SRK.

Zero Hij Option

This option is set on the Binary Coeffs tab of the Fluid Package property view.

HYSYS automatically generates hydrocarbon-hydrocarbon interaction parameters when values are unknown if the Estimate HC-HC/Set Non HC-HC to 0.0 radio button is selected. The Set All to 0.0 radio button turns off the automatic calculation of any estimated interaction coefficients between hydrocarbons. All binary interaction parameters that are obtained from the pure component library remain.

Figure A.2

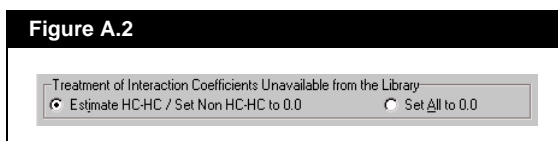

The Set All to 0.0 option may prove useful when trying to match results from other commercial simulators which may not supply interaction parameters for higher molecular weight hydrocarbons.

A.3.2 Activity Models

Although equation of state models have proven to be reliable in predicting properties of most hydrocarbon based fluids over a large range of operating conditions, their application is limited to primarily non-polar or slightly polar components. Polar or non-ideal chemical systems are traditionally handled using dual model approaches. In this approach, an equation of state is used for predicting the vapour fugacity coefficients (normally ideal gas assumption or the Redlich Kwong, Peng-Robinson or SRK equations of state, although a Virial equation of state is available for specific applications) and an activity coefficient model is used for the liquid phase. Although there is considerable research being conducted to extend equation of state applications into the chemical arena (e.g., the PRSV equation), the state of the art of property predictions for chemical systems is still governed mainly by Activity Models.

Activity Models are much more empirical in nature when compared to the property predictions (equations of state) typically used in the hydrocarbon industry. For example, they cannot be used as reliably as the equations of state for generalized application or extrapolating into untested operating conditions. Their tuning parameters should be fitted against a representative sample of experimental data and their application should be limited to moderate pressures. Consequently, more caution should be exercised when selecting these models for your simulation.

The phase separation or equilibrium ratio K_i for component i , defined in terms of the vapour phase fugacity coefficient and the liquid phase activity coefficient is calculated from the following expression:

Activity Models produce the best results when they are applied in the operating region for which the interaction parameters were regressed.

$$K_i = \frac{y_i}{x_i} = \frac{\gamma_i f_i^\circ}{P\phi_i} \quad (\text{A.7})$$

where: γ_i = liquid phase activity coefficient of component i

f_i° = standard state fugacity of component i

P = system pressure

ϕ_i = vapour phase fugacity coefficient of component i

Although for ideal solutions the activity coefficient is unity, for most chemical (non-ideal) systems this approximation is incorrect. Dissimilar chemicals normally exhibit not only large deviations from an ideal solution, but the deviation is also found to be a strong function of the composition. To account for this non-ideality, activity models were developed to predict the activity coefficients of the components in the liquid phase. The derived correlations were based on the excess Gibbs energy function, which is defined as the observed Gibbs energy of a mixture in excess of what it would be if the solution behaved ideally, at the same temperature and pressure.

For a multi-component mixture consisting of n_i moles of component i , the total excess Gibbs free energy is represented by the following expression:

$$G^E = RT \sum (n_i \ln \gamma_i) \quad (\text{A.8})$$

where: γ_i is the activity coefficient for component i

The individual activity coefficients for any system can be obtained from a derived expression for excess Gibbs energy function coupled with the Gibbs-Duhem equation. The early models (Margules, van Laar) provide an empirical representation of the excess function that limits their application. The newer models such as Wilson, NRTL and UNIQUAC utilize the local composition concept and provide an improvement in their general application and reliability. All of these models involve the concept of binary interaction parameters and require that they be fitted to experimental data.

Since the Margules and van Laar models are less complex than the Wilson, NRTL and UNIQUAC models, they require less CPU time for solving flash calculations. However, these are older and more empirically based models and generally give poor results for strongly non-ideal mixtures such as alcohol-hydrocarbon systems, particularly for dilute regions. The Chien-Null model provides the ability to incorporate the different activity models within a consistent thermodynamic framework. Each binary can be represented by the model which best predicts its behaviour.

The following table briefly summarizes recommended models for different applications (for a more detailed review, refer to the texts “The Properties of Gases & Liquids”⁸ and “Molecular Thermodynamics of Fluid Phase Equilibria”⁹).

Application	Margules	van Laar	Wilson	NRTL	UNIQUAC
Binary Systems	A	A	A	A	A
Multicomponent Systems	LA	LA	A	A	A
Azeotropic Systems	A	A	A	A	A
Liquid-Liquid Equilibria	A	A	N/A	A	A
Dilute Systems	?	?	A	A	A
Self-Associating Systems	?	?	A	A	A

Application	Margules	van Laar	Wilson	NRTL	UNIQUAC
Polymers	N/A	N/A	N/A	N/A	A
Extrapolation	?	?	G	G	G

A = Applicable; N/A = Not Applicable; ? = Questionable; G = Good; LA = Limited Application

Vapour phase non-ideality can be taken into account for each activity model by selecting the Redlich-Kwong, Peng-Robinson or SRK equations of state as the vapour phase model. When one of the equations of state is used for the vapour phase, the standard form of the Poynting correction factor is always used for liquid phase correction. If dimerization occurs in the vapour phase, the Virial equation of state should be selected as the vapour phase model.

All of the binary parameters in the HYSYS library are regressed using an ideal gas model for the vapour phase.

The binary parameters required for the activity models are regressed based on the VLE data collected from DECHEMA, Chemistry Data Series³. There are over 16,000 fitted binary pairs in the HYSYS library. The structures of all library components applicable for the UNIFAC VLE estimation are also in the library. The Poynting correction for the liquid phase is ignored if ideal solution behaviour is assumed.

HYSYS internally stored binary parameters are NOT regressed against three phase equilibrium data.

If you are using the built-in binary parameters, the ideal gas model should be used. All activity models, with the exception of the Wilson equation, can automatically calculate three phases given the correct set of energy parameters. The vapour pressures used in the calculation of the standard state fugacity are based on the pure component coefficients in HYSYS' library using the modified form of the Antoine equation.

When your selected components exhibit dimerization in the vapour phase, the Virial option should be selected as the vapour phase model. HYSYS contains fitted parameters for many carboxylic acids, and can estimate values from pure component properties if the necessary parameters are not available. Please refer to [Section A.3.3 - Activity Model Vapour Phase Options](#) for a detailed description of the Virial option.

General Remarks

The dual model approach for solving chemical systems with activity models cannot be used with the same degree of flexibility and reliability that the equations of state can be used for hydrocarbon systems.

However, some checks can be devised to ensure a good confidence level in property predictions:

- Check the property package selected for applicability for the system considered and see how well it matches the pure component vapour pressures. Although the predicted pure component vapour pressures should normally be acceptable, the parameters are fitted over a large temperature range. Improved accuracies can be attained by regressing the parameters over the desired temperature range.
- The automatic UNIFAC generation of energy parameters in HYSYS is a very useful tool and is available for all activity models. However, it must be used with caution. The standard fitted values in HYSYS likely produce a better fit for the binary system than the parameters generated by UNIFAC. As a general rule, use the UNIFAC generated parameters only as a last resort.
- Always use experimental data to regress the energy parameters when possible. The energy parameters in HYSYS are regressed from experimental data, however, improved fits are still possible by fitting the parameters for the narrow operating ranges anticipated. The regressed parameters are based on data taken at atmospheric pressures. Exercise caution when extrapolating to higher or lower pressure (vacuum) applications.
- Check the accuracy of the model for azeotropic systems. Additional fitting may be required to match the azeotrope with acceptable accuracy. Check not only for the temperature, but for the composition as well.
- If three phase behaviour is suspected, additional fitting of the parameters may be required to reliably reproduce the VLLE equilibrium conditions.
- An improvement in matching equilibrium data can be attained by including a temperature dependency of the energy parameters. However, depending on the validity or range of fit, this can lead to misleading results when extrapolating beyond the fitted temperature range.

Please note that the activities for the unknown binaries are generated at pre-selected compositions and the supplied UNIFAC reference temperature.

By default, HYSYS regresses ONLY the a_{ij} parameters while the b_{ij} parameters are set to zero, i.e., the a_{ij} term is assumed to be temperature independent. A temperature dependency can be incorporated by supplying a value for the b_{ij} term. The matrix for the b_{ij} values are displayed by selecting the B_{ij} radio button to switch matrices (note the zero or blank entries for all the binary pairs).

When using the NRTL, General NRTL or Extended NRTL equations, more than two matrices are available. In general, the second matrix is the B_{ij} matrix, and the third matrix is the α_{ij} parameter where $\alpha_{ij} = \alpha_{ji}$. Any component pair with an a_{ij} value has an associated α value.

Immiscible

This option is included for modeling the solubility of solutes in two coexisting liquid phases that are relatively immiscible with one another, such as a H₂O-hydrocarbon system. In this system, the hydrocarbon components (solutes) are relatively insoluble in the water phase (solvent) whereas the solubility of the H₂O in the hydrocarbon phase can become more significant. The limited mutual solubility behaviour can be taken into account when using any activity model with the exception of Wilson.

The Wilson equation does not support LLE equilibrium.

This feature can be implemented for any single component pair by using the Immiscible radio button. Component i is insoluble with component j , based on the highlighted cell location. Alternatively, you can have all j components treated as insoluble with component i . HYSYS replaces the standard binary parameters with those regressed specifically for matching the solubilities of the solutes in both phases. Note that both the a_{ij} and b_{ij} parameters are regressed with this option. These parameters were regressed from the mutual solubility data of n-C₅, n-C₆, n-C₇, and n-C₈ in H₂O over a temperature range of 313 K to 473 K.

The solubility of H₂O in the hydrocarbon phase and the solubility of the hydrocarbons in the water phase are calculated based on the fitted binary parameters regressed from the solubility data referenced above.

Chien-Null

The Chien Null model provides a consistent framework for applying existing activity models on a binary by binary basis. In this manner, the Chien Null model allows you to select the best activity model for each pair in the case.

The Chien Null model allows three sets of coefficients for each component pair, accessible through the A, B and C coefficient matrices. Please refer to the following sections for an explanation of the terms for each of the models.

Chien Null Form

The Chien-Null generalized multi-component equation can be expressed as follows:

$$2 \ln \Gamma_i^L = \frac{\left(\sum_j A_{j,i} x_j \right) \left(\sum_j R_{j,i} x_j \right)}{\left(\sum_j S_{j,i} x_j \right) \left(\sum_j V_{j,i} x_j \right)} + \sum_k x_k \frac{\left(\sum_j A_{j,k} x_j \right) \left(\sum_j R_{j,k} x_j \right)}{\left(\sum_j S_{j,k} x_j \right) \left(\sum_j V_{j,k} x_j \right)} \quad (\text{A.9})$$

$$\left[\frac{A_{i,k}}{\sum_j A_{j,k} x_j} + \frac{R_{i,k}}{\sum_j R_{j,k} x_j} - \frac{S_{i,k}}{\sum_j S_{j,k} x_j} - \frac{V_{i,k}}{\sum_j V_{j,k} x_j} \right]$$

Each of the parameters in this equation are defined specifically for each of the applicable activity methods.

Description of Terms

The Regular Solution equation uses the following:

$$A_{i,j} = \frac{v_i^L (\delta_i - \delta_j)^2}{RT} \quad R_{i,j} = \frac{A_{i,j}}{A_{j,i}} \quad V_{i,j} = |R_{i,j}| \quad S_{i,j} = |R_{i,j}| \quad (\text{A.10})$$

δ_i is the solubility parameter in $(\text{cal}/\text{cm}^3)^{1/2}$ and v_i^L is the saturated liquid volume in cm^3/mol calculated from:

$$v_i^L = v_{\omega,i} (5.7 + 3T_{r,i}) \quad (\text{A.11})$$

The van Laar, Margules and Scatchard Hamer use the following:

Model	$A_{i,j}$	$R_{i,j}$	$S_{i,j}$	$V_{i,j}$
van Laar	$\ln\gamma_{i,j}^{\infty}$	$\frac{A_{i,j}}{A_{j,i}}$	$ R_{i,j} $	$ R_{i,j} $
Margules	$\frac{2\ln\gamma_{i,j}^{\infty}}{1 + \left(\frac{\ln\gamma_{i,j}^{\infty}}{\ln\gamma_{j,i}^{\infty}}\right)}$	$\frac{A_{i,j}}{A_{j,i}}$	1	1
Scatchard Hamer	$\frac{2\ln\gamma_{i,j}^{\infty}}{1 + \left(\frac{\ln\gamma_{i,j}^{\infty}}{\ln\gamma_{j,i}^{\infty}}\right)}$	$\frac{A_{i,j}}{A_{j,i}}$	$\frac{v_i^{\infty}}{v_j^{\infty}}$	$\frac{v_i^{\infty}}{v_j^{\infty}}$

For the van Laar, Margules and Scatchard Hamer equations:

$$\ln\gamma_{i,j}^{\infty} = a_{i,j} + \frac{b_{i,j}}{T} + c_{ij}T \quad (\text{A.12})$$

where: T = temperature unit must be in K

If you have regressed parameters using HYPROP for any of the Activity Models supported under the Chien Null, they are not read in.

Note that this equation is of a different form than the original van Laar and Margules equations in HYSYS, which uses an $a + bT$ relationship. However, since HYSYS only contains a_{ij} values, the difference should not cause problems.

The NRTL form for the Chien Null uses:

$$A_{i,j} = 2\tau_{i,j}V_{i,j} \quad R_{i,j} = 1 \quad V_{i,j} = \exp(-c_{i,j}\tau_{i,j}) \quad S_{i,j} = 1 \quad \tau_{i,j} = a_{i,j} + \frac{b_{i,j}}{T(K)} \quad (\text{A.13})$$

The expression for the τ term under the Chien Null incorporates the R term of HYSYS' NRTL into the values for a_{ij} and b_{ij} . As such, the values initialized for NRTL under Chien Null are not the same as for the regular NRTL. When you select NRTL for a binary pair, a_{ij} is empty (essentially equivalent to the regular NRTL b_{ij} term), b_{ij} is initialized and c_{ij} is the α term for the original NRTL, and is assumed to be symmetric.

The General Chien Null equation is:

$$A_{i,j} = a_{i,j} + \frac{b_{i,j}}{T(K)} \quad R_{i,j} = \frac{A_{i,j}}{A_{j,i}} \quad V_{i,j} = C_{i,j} \quad S_{i,j} = C_{i,j} \quad (\text{A.14})$$

In all cases:

$$A_{i,i} = 0 \quad R_{i,i} = S_{i,i} = V_{i,i} = 1 \quad (\text{A.15})$$

With the exception of the Regular Solution option, all models can utilize six constants, $a_{i,j}$, $a_{j,i}$, $b_{i,j}$, $b_{j,i}$, $c_{i,j}$ and $c_{j,i}$ for each component pair. For all models, if the constants are unknown they can be estimated internally from the UNIFAC VLE or LLE methods, the Insoluble option, or using Henry's Law coefficients for appropriate components. For the general Chien Null model, the c_{ij} 's are assumed to be 1.

Extended & General NRTL

The Extended and General NRTL models are variations of the NRTL model. More binary interaction parameters are used in defining the component activity coefficients. You may apply either model to systems:

- with a wide boiling point range between components.
- where you require simultaneous solution of VLE and LLE, and there exists a wide boiling point range or concentration range between components.

The equations options can be viewed in the Display Form drop-down list on the Binary Coeffs tab of the Fluid Package property view.

You can specify the format for the Equations of τ_{ij} and α_{ij} to be any of the following:

τ_{ij} and α_{ij} Options
$\tau_{ij} = A_{ij} + \frac{B_{ij}}{T} + \frac{C_{ij}}{T^2} + F_{ij}T + G_{ij}\ln(T)$ $\alpha_{ij} = Alp1_{ij} + Alp2_{ij}T$
$\tau_{ij} = \frac{A_{ij} + \frac{B_{ij}}{T}}{RT}$ $\alpha_{ij} = Alp1_{ij}$
$\tau_{ij} = A_{ij} + \frac{B_{ij}}{T} + F_{ij}T + G_{ij}\ln(T)$ $\alpha_{ij} = Alp1_{ij} + Alp2_{ij}T$
$\tau_{ij} = A_{ij} + B_{ij}t + \frac{C_{ij}}{T}$ $\alpha_{ij} = Alp1_{ij} + Alp2_{ij}T$ <p>where: T is in K and t is °C</p>
$\tau_{ij} = A_{ij} + \frac{B_{ij}}{T}$ $\alpha_{ij} = Alp1_{ij}$

Depending on which form of the equations that you have selected, you are able to specify values for the different component energy parameters. The General NRTL model provides radio buttons on the Binary Coeffs tab which access the matrices for the A_{ij} , B_{ij} , C_{ij} , F_{ij} , G_{ij} , $Alp1_{ij}$ and $Alp2_{ij}$ energy parameters.

The Extended NRTL model allows you to input values for the A_{ij} , B_{ij} , C_{ij} , $Alp1_{ij}$ and $Alp2_{ij}$ energy parameters by selecting the appropriate radio button. You do not have a choice of equation format for τ_{ij} and α_{ij} . The following is used:

$$\tau_{ij} = \left(A_{ij} + B_{ij}t + \frac{C_{ij}}{T} \right) \quad (\text{A.16})$$

$$\alpha_{ij} = Alp1_{ij} + Alp2_{ij}$$

where: T = temperature in K

t = temperature in °C

Margules

The equation should not be used for extrapolation beyond the range over which the energy parameters are fitted.

The Margules equation was the first Gibbs excess energy representation developed. The equation does not have any theoretical basis, but is useful for quick estimates and data interpolation. HYSYS has an extended multicomponent Margules equation with up to four adjustable parameters per binary.

The four adjustable parameters for the Margules equation in HYSYS are the a_{ij} and a_{ji} (temperature independent) and the b_{ij} and b_{ji} terms (temperature dependent). The equation uses parameter values stored in HYSYS or any user supplied value for further fitting the equation to a given set of data.

The Margules activity coefficient model is represented by the following equation:

$$\ln \gamma_i = [1.0 - x_i]^2 [A_i + 2x_i(B_i - A_i)] \quad (\text{A.17})$$

where: γ_i = activity coefficient of component i

x_i = mole fraction of component i

$$A_i = \sum_{j=1}^n x_j \frac{(a_{ij} + b_{ij}T)}{(1.0 - x_i)}$$

$$B_i = \sum_{j=1}^n x_j \frac{(a_{ji} + b_{ji}T)}{(1.0 - x_i)}$$

T = temperature (K)

n = total number of components

a_{ij} = non-temperature dependent energy parameter between components i and j

b_{ij} = temperature dependent energy parameter between components i and j [1/K]

a_{ji} = non-temperature dependent energy parameter between components j and i

b_{ji} = temperature dependent energy parameter between components j and i [1/K]

NRTL

The NRTL (Non-Random-Two-Liquid) equation, proposed by Renon and Prausnitz in 1968, is an extension of the original Wilson equation. It uses statistical mechanics and the liquid cell theory to represent the liquid structure. These concepts, combined with Wilson's local composition model, produce an equation capable of representing VLE, LLE and VLE phase behaviour.

Like the Wilson equation, the NRTL is thermodynamically consistent and can be applied to ternary and higher order systems using parameters regressed from binary equilibrium data. It has an accuracy comparable to the Wilson equation for VLE systems.

Unlike the van Laar equation, NRTL can be used for dilute systems and hydrocarbon-alcohol mixtures, although it may not be as good for alcohol-hydrocarbon systems as the Wilson equation.

The NRTL equation in HYSYS contains five adjustable parameters (temperature dependent and independent) for fitting per binary pair. The NRTL combines the advantages of the Wilson and van Laar equations, and, like the van Laar equation, it is not extremely CPU intensive and can represent LLE quite well. It is important to note that because of the mathematical structure of the NRTL equation, it can produce erroneous multiple miscibility gaps.

The NRTL equation in HYSYS has the following form:

$$\ln \gamma_i = \frac{\sum_{j=1}^n \tau_{ji} x_j G_{ji}}{\sum_{k=1}^n x_k G_{ki}} + \sum_{j=1}^n \frac{x_j G_{ij}}{\sum_{k=1}^n x_k G_{kj}} \left(\tau_{ij} - \frac{\sum_{m=1}^n \tau_{mj} x_m G_{mj}}{\sum_{k=1}^n x_k G_{kj}} \right) \quad (\text{A.18})$$

where: γ_i = activity coefficient of component i

$$G_{ij} = \exp[-\tau_{ij} \alpha_{ij}]$$

$$\tau_{ij} = \frac{a_{ij} + b_{ij}T}{RT}$$

x_i = mole fraction of component i

T = temperature (K)

n = total number of components

a_{ij} = non-temperature dependent energy parameter between components i and j (cal/gmol)

b_{ij} = temperature dependent energy parameter between components i and j (cal/gmol-K)

α_{ij} = NRTL non-randomness constant for binary interaction note that $\alpha_{ij} = \alpha_{ji}$ for all binaries

The five adjustable parameters for the NRTL equation in HYSYS are the a_{ij} , a_{ji} , b_{ij} , b_{ji} , and α_{ij} terms. The equation uses parameter values stored in HYSYS or any user supplied value for further fitting the equation to a given set of data.

UNIQUAC

The UNIQUAC (UNIversal QUAsi Chemical) equation proposed by Abrams and Prausnitz in 1975 uses statistical mechanics and the quasi-chemical theory of Guggenheim to represent the liquid structure. The equation is capable of representing LLE, VLE and VLLE with accuracy comparable to the NRTL equation, but without the need for a non-randomness factor. The UNIQUAC equation is significantly more detailed and sophisticated than any of the other activity models. Its main advantage is that a good representation of both VLE and LLE can be obtained for a large range of non-electrolyte mixtures using only two adjustable parameters per binary. The fitted parameters usually exhibit a smaller temperature dependence which makes them more valid for extrapolation purposes.

The UNIQUAC equation utilizes the concept of local composition as proposed by Wilson. Since the primary concentration variable is a surface fraction as opposed to a mole fraction, it is applicable to systems containing molecules of very different sizes and shape, such as polymer solutions. The UNIQUAC equation can be applied to a wide range of mixtures containing H₂O, alcohols, nitriles, amines, esters, ketones, aldehydes, halogenated hydrocarbons and hydrocarbons.

HYSYS contains the following four-parameter extended form of the UNIQUAC equation. The four adjustable parameters for the UNIQUAC equation in HYSYS are the a_{ij} and a_{ji} terms (temperature independent), and the b_{ij} and b_{ji} terms (temperature dependent). The equation uses parameter values stored in HYSYS or any user supplied value for further fitting the equation to a given set of data.

$$\ln \gamma_i = \ln \left(\frac{\Phi_i}{x_i} \right) + 0.5Zq_i \ln \left(\frac{\theta_i}{\Phi_i} \right) + L_i - \left(\frac{\Phi_i}{x_i} \right) \sum_{j=1}^n L_j x_j + q_i \left(1.0 - \ln \sum_{j=1}^n \theta_j \tau_{ji} \right) - q_i \sum_{j=1}^n \left(\frac{\theta_j \tau_{ij}}{\sum_{k=1}^n \theta_k \tau_{kj}} \right) \quad (\text{A.19})$$

where: γ_i = activity coefficient of component i

x_i = mole fraction of component i

T = temperature (K)

n = total number of components

$L_j = 0.5Z(r_j - q_j) - r_j + 1$

$$\theta_i = \frac{q_i x_i}{\sum_j q_j x_j}$$

$$\tau_{ij} = \exp \left[- \frac{a_{ij} + b_{ij} T}{RT} \right]$$

$$\Phi_i = \frac{r_i x_i}{\sum_j r_j x_j}$$

$Z = 10.0$ co-ordination number

a_{ij} = non-temperature dependent energy parameter between components i and j (cal/gmol)

b_{ij} = temperature dependent energy parameter between components i and j (cal/gmol-K)

q_i = van der Waals area parameter - $A_{w_i} / (2.5e9)$

A_w = van der Waals area

r_i = van der Waals volume parameter - $V_{w_i} / (15.17)$

V_w = van der Waals volume

Van Laar

The van Laar equation was the first Gibbs excess energy representation with physical significance. The van Laar equation in HYSYS is a modified form of that described in "Phase Equilibrium in Process Design" by H.R. Null. This equation fits many systems quite well, particularly for LLE component distributions. It can be used for systems that exhibit positive or negative deviations from Raoult's Law, however, it cannot predict maxima or minima in the activity coefficient.

Therefore, it generally performs poorly for systems with halogenated hydrocarbons and alcohols. Due to the empirical nature of the equation, caution should be exercised in analyzing multi-component systems. It also has a tendency to predict two liquid phases when they do not exist.

The van Laar equation also performs poorly for dilute systems and cannot represent many common systems, such as alcohol-hydrocarbon mixtures, with acceptable accuracy.

The van Laar equation has some advantages over the other activity models in that it requires less CPU time and can represent limited miscibility as well as three phase equilibrium. HYSYS uses the following extended, multi-component form of the van Laar equation.

$$\ln \gamma_i = A_i [1.0 - z_i]^2 (1.0 + E_i z_i) \quad (\text{A.20})$$

where: γ_i = activity coefficient of component i

x_i = mole fraction of component i

$$A_i = \sum_{j=1}^n \left[x_j \frac{(a_{ij} + b_{ij}T)}{(1.0 - x_i)} \right]$$

$$B_i = \sum_{j=1}^n \left[x_j \frac{(a_{ji} + b_{ji}T)}{(1.0 - x_i)} \right]$$

$E_i = -4.0$ if A_i and $B_i < 0.0$, otherwise 0.0

$$z_i = \frac{A_i x_i}{[A_i x_i + B_i (1.0 - x_i)]}$$

T = temperature (K)

n = total number of components

a_{ij} = non-temperature dependent energy parameter between components i and j

b_{ij} = temperature dependent energy parameter between components i and j [1/K]

a_{ji} = non-temperature dependent energy parameter between components j and i

b_{ji} = temperature dependent energy parameter between components j and i [1/K]

The four adjustable parameters for the van Laar equation in HYSYS are the a_{ij} , a_{ji} , b_{ij} , and b_{ji} terms. The equation will use parameter values stored in HYSYS or any user supplied value for further fitting the equation to a given set of data.

Wilson

The Wilson equation cannot be used for problems involving liquid-liquid equilibrium.

The Wilson equation, proposed by Grant M. Wilson in 1964, was the first activity coefficient equation that used the local composition model to derive the Gibbs Excess energy expression. It offers a thermodynamically consistent approach to predicting multi-component behaviour from regressed binary equilibrium data. Our experience also shows that the Wilson equation can be extrapolated with reasonable confidence to other operating regions with the same set of regressed energy parameters.

Although the Wilson equation is more complex and requires more CPU time than either the van Laar or Margules equations, it can represent almost all non-ideal liquid solutions satisfactorily except electrolytes and solutions exhibiting limited miscibility (LLE or VLLE). It performs an excellent job of predicting ternary equilibrium using parameters regressed from binary data only.

The Wilson equation gives similar results as the Margules and van Laar equations for weak non-ideal systems, but consistently outperforms them for increasingly non-ideal systems.

Setting all four parameters to zero does not reduce the binary to an ideal solution, but maintains a small effect due to molecular size differences represented by the ratio of molar volumes.

The Wilson equation in HYSYS requires two to four adjustable parameters per binary. The four adjustable parameters for the Wilson equation in HYSYS are the a_{ij} and a_{ji} (temperature independent) terms, and the b_{ij} and b_{ji} terms (temperature dependent). Depending upon the available information, the temperature dependent parameters may be set to zero.

Although the Wilson equation contains terms for temperature dependency, caution should be exercised when extrapolating. The Wilson activity model in HYSYS has the following form:

$$\ln \gamma_i = 1.0 - \ln \sum_{j=1}^n x_j A_{ij} - \sum_{k=1}^n \frac{x_k A_{ki}}{\sum_{j=1}^n x_j A_{kj}} \quad (\text{A.21})$$

where: γ_i = activity coefficient of component i

$$A_{ij} = \frac{V_j}{V_i} \exp \left[-\frac{(a_{ij} + b_{ij}T)}{RT} \right]$$

x_i = mole fraction of component i

T = temperature (K)

n = total number of components

a_{ij} = non-temperature dependent energy parameter between components i and j (cal/gmol)

b_{ij} = temperature dependent energy parameter between components i and j (cal/gmol-K)

V_i = molar volume of pure liquid component i in m^3/kgmol (litres/gmol)

The equation uses parameter values stored in HYSYS or any user supplied value for further fitting the equation to a given set of data.

Henry's Law

Henry's Law cannot be selected explicitly as a property method in HYSYS. However, HYSYS uses Henry's Law when an activity model is selected and "non-condensable" components are included within the component list.

HYSYS considers the following components "non-condensable":

Component	Simulation Name
CH ₄	Methane
C ₂ H ₆	Ethane
C ₂ H ₄	Ethylene
C ₂ H ₂	Acetylene
H ₂	Hydrogen
He	Helium
Ar	Argon
N ₂	Nitrogen
O ₂	Oxygen
NO	NO
H ₂ S	H ₂ S
CO ₂	CO ₂
CO	CO

The extended Henry's Law equation in HYSYS is used to model dilute solute/solvent interactions. "Non-condensable" components are defined as those components that have critical temperatures below the temperature of the system you are modeling. The equation has the following form:

$$\ln H_{ij} = A + \frac{B}{T} + C \ln(T) + DT \quad (\text{A.22})$$

where: i = solute or "non-condensable" component

j = solvent or condensable component

H_{ij} = Henry's coefficient between i and j in kPa

A = A coefficient entered as a_{ij} in the parameter matrix

B = B coefficient entered as a_{ji} in the parameter matrix

C = C coefficient entered as b_{ij} in the parameter matrix

D = D coefficient entered as b_{ji} in the parameter matrix

T = temperature in degrees K

An example of the use of Henry's Law coefficients is illustrated below. The NRTL activity model is selected as the property method. There are three components in the Fluid Package, one of which, ethane, is a "non-condensable" component. On the Binary Coeffs tab of the Fluid Package property view, you can view the Henry's Law coefficients for the interaction of ethane and the other components.

By selecting the A_{ij} radio button, you can view/edit the A and B coefficients. Select the B_{ij} radio button to enter or view the C and D coefficients in the Henry's Law equation.

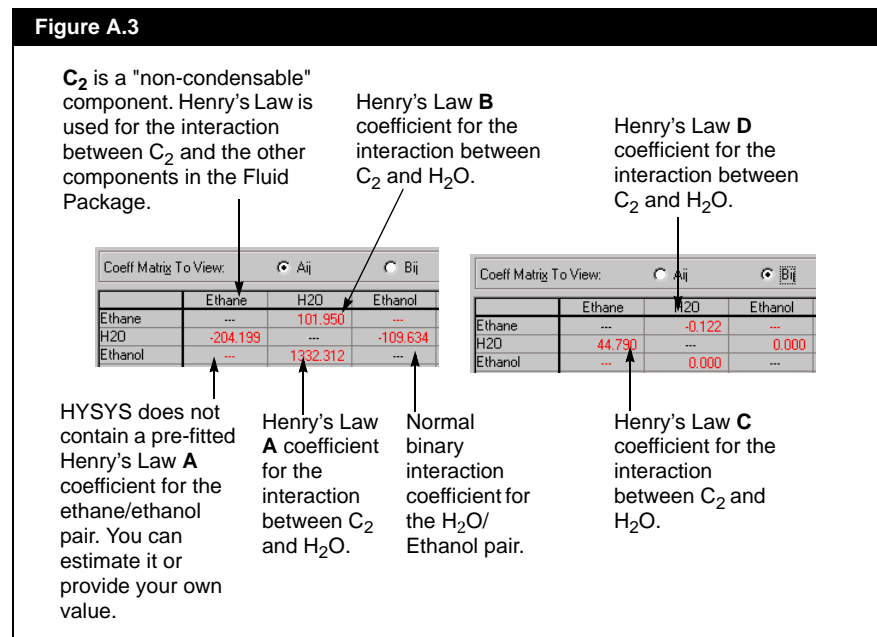

If HYSYS does not contain pre-fitted Henry's Law coefficients and Henry's Law data is not available, HYSYS estimates the missing coefficients. To estimate a coefficient (A or B in this case), select the A_{ij} radio button, highlight a binary pair and press the Individual Pair button. The coefficients are regressed to fugacities calculated using the Chao-Seader/Prausnitz-Shair correlations for standard state fugacity and Regular Solution. To supply your own coefficients you must enter them directly into the A_{ij} and B_{ij} matrices, as shown previously.

No interaction between "non-condensable" component pairs is taken into account in the VLE calculations.

A.3.3 Activity Model Vapour Phase Options

There are several models available for calculating the Vapour Phase in conjunction with the selected liquid activity model. The selection depends on specific considerations of your system. However, in cases when you are operating at moderate pressures (less than 5 atm), selecting Ideal Gas should be satisfactory. The choices are described in the following sections:

Ideal

The ideal gas law is used to model the vapour phase. This model is appropriate for low pressures and for a vapour phase with little intermolecular interaction.

Peng Robinson, SRK or RK

To model non-idealities in the vapour phase, the PR, SRK or RK options can be used in conjunction with an activity model. The PR and SRK vapour phase models handle the same types of situations as the PR and SRK equations of state (refer to [Section A.3.1 - Equations of State](#)).

When selecting one of these options (PR, SRK or RK) as the vapour phase model, you must ensure that the binary interaction parameters used for the activity model remain applicable with the selected vapour model. You must keep in mind that all the binary parameters in the HYSYS Library are regressed using the ideal gas vapour model.

For applications where you have compressors or turbines being modeled within your Flowsheet, PR or SRK is superior to either the RK or ideal vapour model. You obtain more accurate horsepower values by using PR or SRK, as long as the light components within your Flowsheet can be handled by the selected vapour phase model (i.e., C_2H_4 or C_3H_6 are fine, but alcohols are not modeled correctly).

Virial

The Virial option enables you to better model vapour phase fugacities of systems displaying strong vapour phase interactions. Typically this occurs in systems containing carboxylic acids, or compounds that have the tendency to form stable H₂ bonds in the vapour phase. In these cases, the fugacity coefficient shows large deviations from ideality, even at low or moderate pressures.

HYSYS contains temperature dependent coefficients for carboxylic acids. You can overwrite these by changing the Association (*ii*) or Solvation (*ij*) coefficients from the default values.²²

If the virial coefficients need to be calculated, HYSYS contains correlations using the following pure component properties:

- critical temperature
- critical pressure
- dipole moment
- mean radius of gyration
- association parameter
- association parameter for each binary pair

This option is restricted to systems where the density is moderate, typically less than **one-half** the critical density. The Virial equation used is valid for the following range:

$$P \leq \frac{T}{2} \frac{\sum_{i=1}^m y_i P_{c_i}}{\sum_{i=1}^m y_i T_{c_i}} \quad (\text{A.23})$$

A.3.4 Semi-Empirical Methods

The Chao-Seader¹⁰ and Grayson-Streed¹¹ methods are older, semi-empirical methods. The GS correlation is an extension of the CS method with special emphasis on H₂. Only the equilibrium results produced by these correlations is used by HYSYS. The Lee-Kesler method is used for liquid and vapour enthalpies and entropies as its results are shown to be superior to those generated from the CS/GS correlations. This method is also adopted by and recommended for use in the API Technical Data Book.

The following table gives an approximate range of applicability for these two methods, and under what conditions they are applicable.

Method	Temp. (°C)	Temp. (°C)	Press. (psia)	Press. (kPa)
CS	0 to 500	18 to 260	<1,500	<10,000
GS	0 to 800	18 to 425	<3,000	<20,000

Conditions of Applicability	
For all hydrocarbons (except CH ₄):	$0.5 < Tr_1 < 1.3$ and $P_{r,mixture} < 0.8$
If CH ₄ or H ₂ is present:	<ul style="list-style-type: none"> molal average $Tr < 0.93$ CH₄ mole fraction < 0.3 mole fraction dissolved gases < 0.2
When predicting K values for: Paraffinic or Olefinic Mixtures Aromatic Mixtures	liquid phase aromatic mole fraction < 0.5 liquid phase aromatic mole fraction > 0.5

The GS correlation is recommended for simulating heavy hydrocarbon systems with a high H₂ content, such as hydrotreating units. The GS correlation can also be used for simulating topping units and heavy ends vacuum applications.

The vapour phase fugacity coefficients are calculated with the Redlich Kwong equation of state. The pure liquid fugacity coefficients are calculated using the principle of corresponding states. Modified acentric factors are included in HYSYS' GS library for most components. Special functions are incorporated for the calculation of liquid phase fugacities for N₂, CO₂ and H₂S. These functions are restricted to hydrocarbon mixtures with less than five percent of each of the above components.

As with the Vapour Pressure models, H₂O is treated using a combination of the steam tables and the kerosene solubility charts from the API Data Book. This method of handling H₂O is not very accurate for gas systems. Although three phase calculations are performed for all systems, it is important to note that the aqueous phase is always treated as pure H₂O with these correlations.

A.3.5 Vapour Pressure Property Packages

Vapour pressure K value models may be used for ideal mixtures at low pressures. This includes hydrocarbon systems such as mixtures of ketones or alcohols where the liquid phase behaves approximately ideal. The models may also be used for first approximations for non-ideal systems.

The Lee-Kesler model is used for enthalpy and entropy calculations for all vapour pressure models and all components with the exception of H₂O, which is treated separately with the steam property correlation.

All three phase calculations are performed assuming the aqueous phase is pure H₂O and that H₂O solubility in the hydrocarbon phase can be described using the kerosene solubility equation from the API Data Book (Figure 9A1.4).

Because all of the Vapour Pressure options assume an ideal vapour phase, they are classified as Vapour Pressure Models.

Vapour pressures used in the calculation of the standard state fugacity are based on HYSYS' library coefficients and a modified form of the Antoine equation. Vapour pressure coefficients for hypocomponent may be entered or calculated from either the Lee-Kesler correlation for hydrocarbons, the Gomez-Thodos correlation for chemical compounds or the Reidel equation.

The Vapour Pressure options include the Modified Antoine, BraunK10, and EssoK packages.

Approximate ranges of application for each vapour pressure model are given below:

Model	Temperature	Press. (psia)	Press. (kPa)
Mod. Antoine	<1.6 T _c _i	<100	<700
BraunK10	0°F (-17.78°C) <1.6 T _c _i	<100	<700
EssoK	<1.6 T _c _i	<100	<700

Modified Antoine Vapour Pressure Model

The modified Antoine equation assumes the form as set out in the DIPPR data bank.

$$\ln P_{vap} = A + \frac{B}{T+C} + D \ln T + ET^F \quad (\text{A.24})$$

where: A, B, C, D, E and F = fitted coefficients

P_{vap} = the pressure in kPa

T = the temperature in K

These coefficients are available for all HYSYS library components. Vapour pressure coefficients for hypocomponent may be entered or calculated from either the Lee-Kesler correlation for hydrocarbons, the Gomez-Thodos correlation for chemical compounds, or the Reidel equation.

This model is applicable for low pressure systems that behave ideally. For hydrocarbon components that you have not provided vapour pressure coefficients for, the model converts the Lee-Kesler vapour pressure model directly. As such, crude and vacuum towers can be modeled with this equation.

When using this method for super-critical components, it is recommended that the vapour pressure coefficients be replaced with Henry's Law coefficients. Changing Vapour Pressure coefficients can only be accomplished if your component is being installed as a Hypothetical.

All enthalpy and entropy calculations are performed using the Lee-Kesler model.

Braun K10 Model

The Braun K10 model is strictly applicable to heavy hydrocarbon systems at low pressures. The model employs the Braun convergence pressure method, where, given the normal boiling point of a component, the K value is calculated at system temperature and 10 psia. The K10 value is then corrected for pressure using pressure correction charts. The K values for any components that are not covered by the charts are calculated at 10 psia using the modified Antoine equation and corrected to system conditions using the pressure correction charts.

The Lee-Kesler model is used for enthalpy and entropy calculations for all components with the exception of H₂O which is treated with the steam tables.

Accuracy suffers with this model if there are large amounts of acid gases or light hydrocarbons. All three phase calculations assume that the aqueous phase is pure H₂O and that H₂O solubility in the hydrocarbon phase can be described using the kerosene solubility equation from the API Data Book (Figure 9A1.4).

Esso H Model

The Esso Tabular model is strictly applicable to hydrocarbon systems at low pressures. The model employs a modification of the Maxwell-Bonnel vapour pressure model in the following format:

$$\log P_{vap} = \sum A_i x^i \quad (\text{A.25})$$

where: $A_i = \text{fitted constants}$

$$x^i = \frac{\frac{T_b^i}{T} - 0.0002867 T_b^i}{748.1 - 0.2145 T_b^i}$$

$T_b^i = \text{normal boiling point corrected to } K = 12$

$T = \text{absolute temperature}$

$K = \text{Watson characterisation factor}$

Note that the Lee-Kesler model is used for enthalpy and entropy calculations for all components with the exception of H₂O which is treated with the steam tables.

For heavy hydrocarbon systems, the results are comparable to the modified Antoine equation since no pressure correction is applied. For non-hydrocarbon components, the K value is calculated using the Antoine equation. Accuracy suffers if there is a large amount of acid gases or light hydrocarbons. All three phase calculations are performed assuming the aqueous phase is pure H₂O and that H₂O solubility in the hydrocarbon phase can be described using the kerosene solubility equation from the API Data Book (Figure 9A1.4).

A.3.6 Miscellaneous - Special Application Methods

Amines Property Package

For the Amine property method, the vapour phase is modeled using the PR model.

The amines package contains the thermodynamic models developed by D.B. Robinson & Associates for their proprietary amine plant simulator, called AMSIM. Their amine property package is available as an option with HYSYS giving you access to a proven third party property package for reliable amine plant simulation, while maintaining the ability to use HYSYS' powerful flowsheeting capabilities.

The chemical and physical property data base is restricted to amines and the following components:

Component Class	Specific Components
Acid Gases	CO ₂ , H ₂ S, COS, CS ₂
Hydrocarbons	CH ₄ C ₇ H ₁₆
Olefins	C ₂ =, C ₃ =
Mercaptans	M-Mercaptan, E-Mercaptan
Non Hydrocarbons	H ₂ , N ₂ , O ₂ , CO, H ₂ O

This method does not allow any hypotheticals.

The equilibrium acid gas solubility and kinetic parameters for the aqueous alkanolamine solutions in contact with H₂S and CO₂ are incorporated into their property package. The amines property package is fitted to extensive experimental data gathered from a combination of D.B. Robinson's in-house data, several unpublished sources, and numerous technical references.

The following table gives the equilibrium solubility limitations that should be observed when using this property package:

Alkanolamine	Alkanolamine Concentration (wt%)	Acid Gas Partial Pressure (psia)	Temperature (°F)
Monoethanolamine, MEA	0 - 30	0.00001 - 300	77 - 260
Diethanolamine, DEA	0 - 50	0.00001 - 300	77 - 260
Triethanolamine, TEA	0 - 50	0.00001 - 300	77 - 260
Methyldiethanolamine, MDEA*	0 - 50	0.00001 - 300	77 - 260
Diglycolamine, DGA	50 - 70	0.00001 - 300	77 - 260
DlsoPropanolAmine, DlsoA	0 - 40	0.00001 - 300	77 - 260

* The amine mixtures, DEA/MDEA and MEA/MDEA are assumed to be primarily MDEA, so use the MDEA value for these mixtures.

It is important to note that data is not correlated for H₂S and CO₂ loadings greater than 1.0 mole acid gas/mole alkanolamine.

The absorption of H₂S and CO₂ by aqueous alkanolamine solutions involves exothermic reactions. The heat effects are an important factor in amine treating processes and are properly taken into account in the amines property package. Correlations for the heats of solution are set up as a function of composition and amine type. The correlations were generated from existing published values or derived from solubility data using the Gibbs-Helmholtz equation.

The amines package incorporates a specialized stage efficiency model to permit simulation of columns on a real tray basis. The stage efficiency model calculates H₂S and CO₂ component stage efficiencies based on the tray dimensions given and the calculated internal tower conditions for both absorbers and strippers. The individual component stage efficiencies are a function of pressure, temperature, phase compositions, flow rates, physical properties, mechanical tray design and dimensions as well as kinetic and mass transfer parameters.

Since kinetic and mass transfer effects are primarily responsible for the H₂S selectivity demonstrated by amine solutions, this must be accounted for by non unity stage efficiencies. See [Chapter 8 - Column](#) of the **Operations guide** for details on how to specify or have HYSYS calculate the stage efficiencies.

Steam Package

HYSYS includes two steam packages:

- ASME Steam
- NBS Steam

Both of these property packages are restricted to a single component, namely H₂O.

ASME Steam accesses the ASME 1967 steam tables. The limitations of this steam package are the same as those of the original ASME steam tables, i.e., pressures less than 15,000 psia and temperatures greater than 32°F (0°C) and less than 1,500°F.

The basic reference is the book “Thermodynamic and Transport Properties of Steam” - The American Society of Mechanical Engineers - Prepared by C.A. Meyer, R.B. McClintock, G.J. Silvestri and R.C. Spencer Jr.²⁰

Selecting NBS_Steam uses the NBS 1984 Steam Tables, which reportedly has better calculations near the Critical Point.

MBWR

In HYSYS, a 32-term modified BWR equation of state is used. The modified BWR may be written in the following form:

$$P = RT\rho + \sum_{i=1}^{32} N_i X_i \quad (\text{A.26})$$

where:

$$\begin{array}{lllll}
 X_1 = \rho^2 T & X_8 = \rho^3 / T & X_{15} = \rho^6 / T^2 & X_{22} = \rho^5 F / T^2 & X_{29} = \rho^{11} F / T^3 \\
 X_2 = \rho^2 T^{1/2} & X_9 = \rho^3 / T_2 & X_{16} = \rho^7 / T & X_{23} = \rho^5 F / T^4 & X_{30} = \rho^{13} F / T^2 \\
 X_3 = \rho^2 & X_{10} = \rho^4 T & X_{17} = \rho^8 / T & X_{24} = \rho^7 F / T^2 & X_{31} = \rho^{13} F / T^3 \\
 X_4 = \rho^2 / T & X_{11} = \rho^4 & X_{18} = \rho^8 / T^2 & X_{25} = \rho^7 F / T^3 & X_{32} = \rho^{13} F / T^4 \\
 X_5 = \rho^2 / T^2 & X_{12} = \rho^4 / T & X_{19} = \rho^9 / T_2 & X_{26} = \rho^9 F / T^2 & \\
 X_6 = \rho^3 T & X_{13} = \rho^5 & X_{20} = \rho^3 F / T_2 & X_{27} = \rho^9 F / T^4 & \\
 X_7 = \rho^3 & X_{14} = \rho^6 / T & X_{21} = \rho^3 F / T_3 & X_{28} = \rho^{11} F / T^2 &
 \end{array}$$

$$F = \exp(-0.0056 r_2)$$

The modified BWR is applicable only for the following pure components:

Component	Temp. (K)	Temp. (R)	Max. Press. (MPa)	Max. Press. (psia)
Ar	84 - 400	151.2 - 720	100	14,504
CH ₄	91 - 600	163.8 - 1,080	200	29,008
C ₂ H ₄	104 - 400	187.2 - 720	40	5,802
C ₂ H ₆	90 - 600	162. - 1,080	70	10,153
C ₃ H ₈	85 - 600	153. - 1080	100	14,504
i-C ₄	114 - 600	205.2 - 1,080	35	5,076
n-C ₄	135 - 500	243. - 900	70	10,153
CO	68 - 1,000	122.4 - 1,800	30	4,351
CO ₂	217 - 1,000	390.6 - 1,800	100	14,504
D ₂	29 - 423	52.2 - 761.4	320	46,412
H ₂	14 - 400	25.2 - 720	120	17,405
o-H ₂	14 - 400	25.2 - 720	120	17,405
p-H ₂	14 - 400	25.2 - 720	120	17,405
He	0.8 - 1,500	1.4 - 2,700	200	29,008
N ₂	63 - 1,900	113.4 - 3,420	1,000	145,038
O ₂	54 - 400	97.2 - 720	120	17,405
Xe	161 - 1,300	289.8 - 2,340	100	14,504

Note that mixtures of different forms of H₂ are also acceptable. The range of use for these components is shown in this table.

A.4 Enthalpy & Entropy Departure Calculations

With semi-empirical and vapour pressure models, a pure liquid water phase is generated and the solubility of H₂O in the hydrocarbon phase is determined from the kerosene solubility model.

The Ideal Gas Enthalpy basis (H^{ID}) used by HYSYS is equal to the ideal gas Enthalpy of Formation at 25°C and 1 atm.

The Enthalpy and Entropy calculations are performed rigorously by HYSYS using the following exact thermodynamic relations:

$$\frac{H - H^{ID}}{RT} = Z - 1 + \frac{1}{RT} \int_{\infty}^V \left[T \left(\frac{\partial P}{\partial T} \right)_V - P \right] dV \quad (\text{A.27})$$

$$\frac{S - S_o^{ID}}{RT} = \ln Z - \ln \frac{P}{P^o} + \int_{\infty}^V \left[\frac{1}{R} \left(\frac{\partial P}{\partial T} \right)_V - \frac{1}{V} \right] dV \quad (\text{A.28})$$

A.4.1 Equations of State

For the Peng-Robinson Equation of State, the enthalpy and entropy departure calculations use the following relations:

The Ideal Gas Enthalpy basis (H^{ID}) used by HYSYS changes with temperature according to the coefficients on the TDep tab for each individual component.

$$\frac{H - H^{ID}}{RT} = Z - 1 - \frac{1}{2^{1.5} b R T} \left[a - T \frac{da}{dt} \right] \ln \left(\frac{V + (2^{0.5} + 1)b}{V + (2^{0.5} - 1)b} \right) \quad (\text{A.29})$$

$$\frac{S - S_o^{ID}}{R} = \ln(Z - B) - \ln \frac{P}{P^o} - \frac{A}{2^{1.5} b R T} \left[\frac{T da}{a dt} \right] \ln \left(\frac{V + (2^{0.5} + 1)b}{V + (2^{0.5} - 1)b} \right) \quad (\text{A.30})$$

where:

$$a = \sum_{i=1}^N \sum_{j=1}^N x_i x_j (a_i a_j)^{0.5} (1 - k_{ij}) \quad (\text{A.31})$$

For the SRK Equation of State:

$$\frac{H - H^{ID}}{RT} = Z - 1 - \frac{1}{bRT} \left[a - T \frac{da}{dT} \right] \ln \left(1 + \frac{b}{V} \right) \quad (\text{A.32})$$

$$\frac{S - S_o^{ID}}{RT} = \ln(Z - b) - \ln \frac{P}{P_o} + \frac{A}{B} \left[\frac{T da}{a dt} \right] \ln \left(1 + \frac{B}{Z} \right) \quad (\text{A.33})$$

A and B term definitions are provided below:

	Peng-Robinson	Soave-Redlich-Kwong
b_i	$0.077796 \frac{RT_{ci}}{P_{ci}}$	$0.08664 \frac{RT_{ci}}{P_{ci}}$
a_i	$a_{ci} \alpha_i$	$a_{ci} \alpha_i$
a_{ci}	$0.457235 \frac{(RT_{ci})^2}{P_{ci}}$	$0.42748 \frac{(RT_{ci})^2}{P_{ci}}$
$\sqrt{\alpha_i}$	$1 + m_i (1 - T_{ri}^{0.5})$	$1 + m_i (1 - T_{ri}^{0.5})$
m_i	$0.37646 + 1.54226 \omega_i - 0.26992 \omega_i^2$	$0.48 + 1.574 \omega_i - 0.176 \omega_i^2$

where:

$$a = \sum_{i=1}^N \sum_{j=1}^N x_i x_j (a_i a_j)^{0.5} (1 - k_{ij})$$

R = Ideal Gas constant

H = Enthalpy

S = Entropy

subscripts:

$ID = \text{Ideal Gas}$

$o = \text{reference state}$

PRSV

The PRSV equation of state is an extension of the Peng-Robinson equation using an extension of the κ expression as shown below:

$$\begin{aligned}\alpha_i &= [1 + \kappa_i(1 - T_r^{0.5})]^2 \\ \kappa_i &= \kappa_{0i}(1 + T_{ri}^{0.5})(0.7 - T_{ri}) \\ \kappa_{0i} &= 0.378893 + 1.4897153\omega_i - 0.17131848\omega_i^2 + 0.0196554\omega_i^3\end{aligned}\tag{A.34}$$

This results in the replacement of the α_i term in the definitions of the **A** and **B** terms shown previously by the α_i term shown above.

A.4.2 Activity Models

The Liquid enthalpy and entropy for Activity Models is based on the Cavett Correlation as shown below:

for $T_{ri} < 1$:

$$\frac{H^L - H^{ID}}{T_{c_i}} = \max\left(\frac{\Delta H_i^{\circ L}(sb)}{T_{c_i}}, \frac{\Delta H_i^{\circ L}(sb)}{T_{c_i}}\right)\tag{A.35}$$

for $T_{ri} \geq 1$:

$$\frac{H^L - H^{ID}}{T_{c_i}} = \max\left(\frac{\Delta H_i^{\circ L}(sb)}{T_{c_i}}, \frac{\Delta H_i^{\circ L}(sp)}{T_{c_i}}\right)\tag{A.36}$$

where:

$$\frac{\Delta H_i^{\circ L}(sb)}{T_{c_i}} = a_1 + a_2(1 - T_{r_i})^{1 - a_3(T_{r_i} - 0.1)} \quad (\text{A.37})$$

$$\frac{\Delta H_i^{\circ L}(sp)}{T_{c_i}} = \max(0, b_1 + b_2 T_{r_i}^2 + b_3 T_{r_i}^3 + b_4 T_{r_i}^4 + b_5 T_{r_i}^5) \quad (\text{A.38})$$

where a_1 , a_2 , and a_3 are functions of the Cavett parameter, fitted to match one known heat of vapourization.

The Gas enthalpies and entropies are dependent on the model chosen to represent the vapour phase behaviour:

Ideal Gas:

$$H = H^{ID} \quad (\text{A.39})$$

$$S = S_o^{ID} = \int_{T_1}^{T_2} \frac{C_p dT}{T} + R \ln \frac{V_2}{V_1} \quad (\text{A.40})$$

Redlich-Kwong:

$$\frac{H - H^{ID}}{RT} = Z - 1 - \frac{1.5}{bRT} \ln \left(1 + \frac{b}{V} \right) \quad (\text{A.41})$$

$$\frac{S - S_o^{ID}}{RT} = \ln(Z - b) - \ln \frac{P}{P^\circ} + \frac{A}{2B} \ln \left(1 + \frac{B}{Z} \right) \quad (\text{A.42})$$

Virial Equation:

$$\frac{H - H^{ID}}{RT} = - \frac{T}{V - B} \frac{dB}{dt} + (Z - 1) \quad (\text{A.43})$$

$$\frac{S - S^{\circ ID}}{R} = -\frac{RT}{V-B} \frac{dB}{dT} - R \ln \frac{V}{V-B} + R \ln \frac{V}{V^{\circ}} \quad (\text{A.44})$$

where: B = second virial coefficient of the mixture

A.4.3 Lee-Kesler Option

The SRK and PR are given in [Section A.3.1 - Equations of State](#).

The Lee and Kesler method is an effort to extend the method originally proposed by Pitzer to temperatures lower than $0.8 T_r$. Lee and Kesler expanded Pitzer's method expressing the compressibility factor as:

$$Z = Z^{\circ} + \frac{\omega}{\omega_r} (Z^r - Z^{\circ}) \quad (\text{A.45})$$

where: Z° = the compressibility factor of a simple fluid

Z^r = the compressibility factor of a reference fluid

They chose the reduced form of the BWR equation of state to represent both Z° and Z^r :

$$Z = 1 + \frac{B}{V_r} + \frac{C}{V_r^2} + \frac{D}{V_r^5} + \frac{D}{T_r^3 V_r^3} \left(\beta - \frac{\gamma}{V_r^2} \right) e^{-\left(\frac{\gamma}{V_r^2}\right)} \quad (\text{A.46})$$

where:

$$V_r = \frac{VP_c}{RT_c}$$

$$B = b_1 - \frac{b_2}{T_r} - \frac{b_3}{T_r^2} - \frac{b_4}{T_r^4}$$

$$C = c_1 - \frac{c_2}{T_r} + \frac{c_3}{T_r^3}$$

$$D = d_1 + \frac{d_2}{T_r}$$

The constants in these equations were determined using experimental compressibility and enthalpy data. Two sets of constants, one for the simple fluid ($\omega^0 = 0$) and one for the reference fluid ($\omega^r=0.3978$, n-C₈) were determined.

The Enthalpy and Entropy departures are computed as follows:

$$\frac{H-H^{ID}}{RT_c} = T_r \left\{ Z - 1 - \frac{b_2 + 2\frac{b_3}{T_r} + 3\frac{b_4}{T_r^2}}{T_r V_r} - \frac{c_2 - 3\frac{c_3}{T_r}}{2T_r V_r^2} - \frac{d_2}{5T_r V_r^5} + 3E \right\} \quad (\text{A.47})$$

$$\frac{S-S_o^{ID}}{R} = \ln Z - \ln\left(\frac{P}{P^o}\right) - \frac{b_1 + \frac{b_3}{T_r^2} + 2\frac{b_4}{T_r^3}}{V_r} - \frac{c_1 - 3\frac{c_3}{T_r}}{2V_r^2} - \frac{d_1}{5V_r^2} + 2E \quad (\text{A.48})$$

$$E = \frac{c_4}{2T_r^3 \gamma} \left\{ \beta + 1 - \left(\beta + 1 + \frac{\gamma}{V_r^2} \right) e^{-\left(\frac{\gamma}{V_r}\right)} \right\} \quad (\text{A.49})$$

For mixtures, the Critical Properties are defined as follows:

$$\begin{aligned} \omega &= \sum_{i=1}^N x_i \omega_i \\ z_{c_i} &= 0.2905 - 0.0851 \omega_i \\ V_{c_i} &= \frac{Z_{c_i} R T_{c_i}}{P_{c_i}} \\ V_c &= \frac{1}{8} \sum_{i=1}^N \sum_{j=1}^N x_i x_j \left(V_{c_i}^{\frac{1}{3}} + V_{c_j}^{\frac{1}{3}} \right)^3 \\ T_c &= \frac{1}{8V_c} \sum_{i=1}^N \sum_{j=1}^N x_i x_j \left(V_{c_i}^{\frac{1}{3}} + V_{c_j}^{\frac{1}{3}} \right)^3 (T_{c_i} T_{c_j})^{0.5} \\ P_c &= (0.2905 - 0.085 \omega) \frac{R T_c}{V_c} \end{aligned}$$

Fugacity Coefficient

The fugacity coefficient calculations for SRK and Peng Robinson models is shown below.

Soave-Redlich-Hwong

$$\ln \phi_i = -\ln\left(Z - \frac{Pb}{RT}\right) + (Z-1)\frac{b_i}{b} - \frac{a}{bRT} \left[\frac{1}{a} \left(2a_i^{0.5} \sum_{j=1}^N x_j a_j^{0.5} (1 - k_{ij}) \right) - \frac{b_i}{b} \right] \ln\left(1 + \frac{b}{V}\right) \quad (\text{A.50})$$

Peng Robinson

$$\ln \phi_i = -\ln\left(Z - \frac{Pb}{RT}\right) + (Z-1)\frac{b_i}{b} - \frac{a}{2^{1.5}bRT} \left[\frac{1}{a} \left(2a_i^{0.5} \sum_{j=1}^N x_j a_j^{0.5} (1 - k_{ij}) \right) - \frac{b_i}{b} \right] \ln \left[\frac{V + (2^{0.5} + 1)b}{V - (2^{0.5} - 1)b} \right] \quad (\text{A.51})$$

A.5 Physical & Transport Properties

The physical and transport properties that HYSYS calculates for a given phase are viscosity, density, thermal conductivity and surface tension. The models used for the transport property calculations are all pre-selected to yield the best fit for the system under consideration. For example, the corresponding states model proposed by Ely and Hanley is used for viscosity predictions of light hydrocarbons (NBP<155), the Twu methodology for heavier hydrocarbons, and a modification of the Letsou-Stiel method for predicting the liquid viscosities of non-ideal chemical systems.

A complete description of the models used for the prediction of the transport properties can be found in the references listed in each subsection. All these models are modified by Hyprotech to improve the accuracy of the correlations.

In the case of multiphase streams, the transport properties for the mixed phase are meaningless and are reported as <empty>, although the single phase properties are known. There is an exception with the pipe and heat exchanger operations. For three-phase fluids, HYSYS uses empirical mixing rules to determine the apparent properties for the combined liquid phases.

A.5.1 Liquid Density

Saturated liquid volumes are obtained using a corresponding states equation developed by R. W. Hankinson and G. H. Thompson¹³ which explicitly relates the liquid volume of a pure component to its reduced temperature and a second parameter termed the characteristic volume. This method is adopted as an API standard. The pure compound parameters needed in the corresponding states liquid density (COSTALD) calculations are taken from the original tables published by Hankinson and Thompson, and the API Data Book for components contained in HYSYS' library.

The parameters for hypothetical components are based on the API gravity and the generalized Lu equation. Although the COSTALD method was developed for saturated liquid densities, it can be applied to sub-cooled liquid densities, i.e., at pressures greater than the vapour pressure, using the Chueh and Prausnitz correction factor for compressed fluids. It is used to predict the density for all systems whose pseudo-reduced temperature is below 1.0. Above this temperature, the equation of state compressibility factor is used to calculate the liquid density.

Hypocomponents generated in the Oil Characterization Environment have their densities either calculated from internal correlations or generated from input curves. Given a bulk density, the densities of the hypocomponent are adjusted such that:

$$\rho_{bulk} = \frac{1.0}{\sum \frac{x_i}{\rho_i^o}} \quad (A.52)$$

The characteristic volume for each hypocomponent is calculated using the adjusted densities and the physical properties. The calculated characteristic volumes are then adjusted such that the bulk density calculated from the COSTALD equation matches the density calculated using the above equation. This ensures that a given volume of fluid contains the same mass whether it is calculated with the sum of the component densities or the COSTALD equation.

A.5.2 Vapour Density

The density for all vapour systems at a given temperature and pressure is calculated using the compressibility factor given by the equation of state or by the appropriate vapour phase model for Activity Models.

A.5.3 Viscosity

HYSYS automatically selects the model best suited for predicting the phase viscosities of the system under study. The model selected is from one of the three available in HYSYS: a modification of the NBS method (Ely and Hanley), Twu's model, or a modification of the Letsou-Stiel correlation. HYSYS selects the appropriate model using the following criteria:

Chemical System	Vapour Phase	Liquid Phase
Lt Hydrocarbons (NBP<155°F)	Mod Ely & Hanley	Mod Ely & Hanley
Hvy Hydrocarbons (NBP>155°F)	Mod Ely & Hanley	Twu
Non-Ideal Chemicals	Mod Ely & Hanley	Mod Letsou-Stiel

All of the models are based on corresponding states principles and are modified for more reliable application. Internal validation showed that these models yielded the most reliable results for the chemical systems shown. Viscosity predictions for light hydrocarbon liquid phases and vapour phases were found to be handled more reliably by an in-house modification of the original Ely and Hanley model, heavier hydrocarbon liquids were more effectively handled by Twu's model, and chemical systems were more accurately handled by an in-house modification of the original Letsou-Stiel model.

A complete description of the original corresponding states (NBS) model used for viscosity predictions is presented by Ely and Hanley in their NBS publication. The original model is modified to eliminate the iterative procedure for calculating the system shape factors. The generalized Leech-Leland shape factor models are replaced by component specific models. HYSYS constructs a PVT map for each component using the COSTALD for the liquid region. The shape factors are adjusted such that the PVT map can be reproduced using the reference fluid.

The shape factors for all the library components are already regressed and included in the Pure Component Library. Hypocomponent shape factors are regressed using estimated viscosities. These viscosity estimations are functions of the hypocomponent Base Properties and Critical Properties.

Hypocomponents generated in the Oil Characterization Environment have the additional ability of having their shape factors regressed to match kinematic or dynamic viscosity assays.

The general model employs CH_4 as a reference fluid and is applicable to the entire range of non-polar fluid mixtures in the hydrocarbon industry. Accuracy for highly aromatic or naphthenic crudes is increased by supplying viscosity curves when available, since the pure component property generators were developed for average crude oils. The model also handles H_2O and acid gases as well as quantum gases.

Although the modified NBS model handles these systems very well, the Twu method was found to do a better job of predicting the viscosities of heavier hydrocarbon liquids. The Twu model⁹ is also based on corresponding states principles, but has implemented a viscosity correlation for n-alkanes as its reference fluid instead of CH_4 . A complete description of this model is given in the paper entitled "Internally Consistent Correlation for Predicting Liquid Viscosities of Petroleum Fractions"¹⁵.

For chemical systems the modified NBS model of Ely and Hanley is used for predicting vapour phase viscosities, whereas a modified form of the Letsou-Stiel model is used for predicting the liquid viscosities. This method is also based on corresponding states principles and was found to perform satisfactorily for the components tested.

The shape factors contained in the HYSYS Pure Component Library are fit to match experimental viscosity data over a broad operating range. Although this yields good viscosity predictions as an average over the entire range, improved accuracy over a narrow operating range can be achieved by using the Tabular features (see [Chapter 2 - Fluid Package](#) for more information).

A.5.4 Liquid Phase Mixing Rules for Viscosity

The estimates of the apparent liquid phase viscosity of immiscible Hydrocarbon Liquid - Aqueous mixtures are calculated using the following "mixing rules":

- If the volume fraction of the hydrocarbon phase is greater than or equal to 0.5, the following equation is used¹⁷:

$$\mu_{eff} = \mu_{oil} e^{3.6(1 - v_{oil})} \quad (A.53)$$

where: μ_{eff} = apparent viscosity

μ_{oil} = viscosity of Hydrocarbon phase

v_{oil} = volume fraction Hydrocarbon phase

- If the volume fraction of the hydrocarbon phase is less than 0.33, the following equation is used¹⁸:

$$\mu_{eff} = \left[1 + 2.5 v_{oil} \left(\frac{\mu_{oil} + 0.4 \mu_{H_2O}}{\mu_{oil} + \mu_{H_2O}} \right) \right] \mu_{H_2O} \quad (A.54)$$

where: μ_{eff} = apparent viscosity

μ_{oil} = viscosity of Hydrocarbon phase

μ_{H_2O} = viscosity of Aqueous phase

v_{oil} = volume fraction Hydrocarbon phase

- If the volume of the hydrocarbon phase is between 0.33 and 0.5, the effective viscosity for combined liquid phase is calculated using a weighted average between [Equation \(A.53\)](#) and [Equation \(A.54\)](#).

The remaining properties of the pseudo phase are calculated as follows:

$$\begin{aligned}
 MW_{eff} &= \sum x_i MW_i && \text{(molecular weight)} \\
 \rho_{eff} &= \frac{1}{\sum \left(\frac{x_i}{\rho_i} \right)} && \text{(mixture density)} \\
 C_{p_{eff}} &= \sum x_i C_{p_i} && \text{(mixture specific heat)}
 \end{aligned}
 \tag{A.55}$$

A.5.5 Thermal Conductivity

As in viscosity predictions, a number of different models and component specific correlations are implemented for prediction of liquid and vapour phase thermal conductivities. The text by Reid, Prausnitz and Poling¹⁶ was used as a general guideline in determining which model was best suited for each class of components.

For hydrocarbon systems the corresponding states method proposed by Ely and Hanley¹⁴ is generally used. The method requires molecular weight, acentric factor and ideal heat capacity for each component. These parameters are tabulated for all library components and may either be input or calculated for hypothetical components. It is recommended that all of these parameters be supplied for non-hydrocarbon hypotheticals to ensure reliable thermal conductivity coefficients and enthalpy departures.

The modifications to the method are identical to those for the viscosity calculations. Shape factors calculated in the viscosity routines are used directly in the thermal conductivity equations. The accuracy of the method depends on the consistency of the original PVT map.

The Sato-Reidel method¹⁶ is used for liquid phase thermal conductivity predictions of glycols and acids, the Latini et al. method¹⁶ is used for esters, alcohols and light hydrocarbons in the range of C₃ - C₇, and the Missenard and Reidel method¹⁶ is used for the remaining components.

For *vapour* phase thermal conductivity predictions, the Misic and Thodos, and Chung et al.¹⁶ methods are used (except for H₂O, C₁, H₂, CO₂, NH₃ which use a polynomial for pure components). The effect of higher pressure on thermal conductivities is taken into account by the Chung et al. method.

For *liquid* phase thermal conductivity predictions:

- For pure water, use the Steam Tables.
- When water and DEG exist at the same time, some special treatment for those two compounds.
- For water, DEG, C₁, C₂, C₃, 3M-3Epentane, propene, TEG, EG, He, H₂, Ethylene, Ammonia, a polynomial is used.
- For Hydrocarbon with MW > 140 and TR < 0.8, a modified Missenard & Reidel method is used. Because the Missenard and Reidel method needs Cp at standard condition, HYSYS does not use the unmodified version.
- For Alcohol, Ester and Hydrocarbons not mentioned in the last category, Latini is used.
- For others, Sato-Reidel is used.

As with viscosity, the thermal conductivity for two liquid phases is approximated by using empirical mixing rules for generating a single pseudo liquid phase property. The thermal conductivity for an immiscible binary of liquid phases is calculated by the following equation²¹:

$$\lambda_{L_i} = \sum_i \sum_j \phi_i \phi_j k_{ij} \quad (\text{A.56})$$

where: κ_{ij} = liquid thermal conductivity of pure component i or j at temperature T

$$k_{ij} = \frac{2}{(1/k_i) + (1/k_j)}$$

$$\phi_i = \frac{x_i V_i}{\sum_{k=1} x_k V_k}$$

x_i = mole fraction of liquid i

V_i - molar volume of liquid i

x_k = mole fraction of component k

V_k = molar volume of component k

For a binary system the equation simplifies to:

$$\lambda_{L_{mix}} = \phi_{L_1}^2 \lambda_{L_1} + 2\phi_{L_1} \phi_{L_2} \lambda_{12} + \phi_{L_2}^2 \lambda_{L_2} \quad (\text{A.57})$$

A.5.6 Surface Tension

Surface tensions for hydrocarbon systems are calculated using a modified form of the Brock and Bird equation⁸. The equation expresses the surface tension, σ , as a function of the reduced and critical properties of the component. The basic form of the equation was used to regress parameters for each family of components.

$$\sigma = P_c^{2/3} T_c^{1/3} Q (1 - T_R)^a \times b \quad (\text{A.58})$$

where: σ = surface tension (dynes/cm²)

$$Q = 0.1207 [1.0 + T_{BR} \ln P_c / (1.0 - T_{BR})] - 0.281$$

T_{BR} = reduced boiling point temperature (T_b/T_c)

a = parameter fitted for each chemical class

$b = c_0 + c_1 \omega + c_2 \omega_2 + c_3 \omega_3$ (parameter fitted for each chemical class, expanded as a polynomial in acentricity)

For aqueous systems, HYSYS employs a polynomial to predict the surface tension. It is important to note that HYSYS predicts only liquid-vapour surface tensions.

A.5.7 Heat Capacity

Heat Capacity is calculated using a rigorous C_v value whenever HYSYS can. The method used is given by the following equations:

$$C_p - C_v = -T \cdot (dV/dT)^2 / (dV/dP) \quad (\text{A.59})$$

However, when ever this equation fails to provide an answer, HYSYS falls back to the semi-ideal C_p/C_v method by computing C_p/C_v as $C_p/(C_p - R)$, which is only approximate and valid for ideal gases. Examples of when HYSYS uses the ideal method are:

- **Equation (A.59)** fails to return an answer
- The stream has a solid phase
- $\text{abs}(dV/dP) < 1\text{e-}12$
- $C_p/C_v < 0.1$ or $C_p/C_v > 20$ - this is outside the range of applicability of the equation used so HYSYS falls back to the ideal method

A.6 Volumetric Flow Rate Calculations

HYSYS has the ability to interpret and produce a wide assortment of flow rate data. It can accept several types of flow rate information for stream specifications as well as report back many different flow rates for streams, their phases and their components. One drawback of the large variety available is that it often leads to some confusion as to what exactly is being specified or reported, especially when volumetric flow rates are involved.

In the following sections, the available flow rates are listed, each corresponding density basis is explained, and the actual formulation of the flow rate calculations is presented. For volumetric flow rate data that is not directly accepted as a stream specification, a final section is provided that outlines techniques to convert your input to mass flow rates.

A.6.1 Available Flow Rates

Many types of flow rates appear in HYSYS output. However, only a subset of these are available for stream specifications.

Flow Rates Reported in the Output

The flow rate types available through the numerous reporting methods - property views, workbook, PFD, specsheets etc. are:

- Molar Flow
- Mass Flow
- Std Ideal Liq Vol Flow
- Liq Vol Flow @Std Cond
- Actual Volume Flow
- Std Gas Flow
- Actual Gas Flow

Flow Rates Available for Specification

The following flow rate types are available for stream specifications:

- Molar Flows
- Mass Flows
- LiqVol Flows

A.6.2 Liquid & Vapour Density Basis

The volumetric flow rate reference state is defined as 60°F and 1 atm when using Field units or 15°C and 1 atm when using SI units.

Actual Densities are calculated at the stream Temperature and Pressure.

All calculations for volumetric stream flows are based on density. HYSYS uses the following density basis:

Density Basis	Description
Std Ideal Liq Mass Density	This is calculated based on ideal mixing of pure component ideal densities at 60°F.
Liq Mass Density @Std Cond	This is calculated rigorously at the standard reference state for volumetric flow rates.
Actual Liquid Density	This is calculated rigorously at the flowing conditions of the stream (i.e., at stream T and P).

Density Basis	Description
Standard Vapour Density	This is determined directly from the Ideal Gas law.
Actual Vapour Density	This is calculated rigorously at the flowing conditions of the stream (i.e., at stream T and P).

Calculation of Standard & Actual Liquid Densities

The Standard and Actual liquid densities are calculated rigorously at the appropriate T and P using the internal methods of the chosen property package. Flow rates based upon these densities automatically take into account any mixing effects exhibited by non-ideal systems. Thus, these volumetric flow rates may be considered as "real world".

Calculation of Standard Ideal Liquid Mass Density

Contrary to the rigorous densities, the Standard Ideal Liquid Mass density of a stream does not take into account any mixing effects due to its simplistic assumptions. Thus, flow rates that are based upon it do not account for mixing effects and are more empirical in nature. The calculation is as follows:

$$Ideal\ Density_{Stream} = \frac{1}{\sum \frac{x_i}{\rho_i^{Ideal}}} \quad (A.60)$$

where: x_i = molar fraction of component i

ρ_i^{Ideal} = pure component Ideal Liquid density

HYSYS contains Ideal Liquid densities for all components in the Pure Component Library. These values are determined in one of three ways, based on the characteristics of the component, as described below:

Case 1 - For any component that is a liquid at 60°F and 1 atm, the data base contains the density of the component at 60°F and 1 atm.

Case 2 - For any component that can be liquified at 60°F and pressures greater than 1 atm, the data base contains the density of the component at 60°F and Saturation Pressure.

Case 3 - For any component that is non-condensable at 60°F under any pressure, i.e., 60°F is greater than the critical temperature of the component, the data base contains GPA tabular values of the equivalent liquid density. These densities were experimentally determined by measuring the displacement of hydrocarbon liquids by dissolved non-condensable components.

For all hypothetical components, the Standard Liquid density (Liquid Mass Density @Std Conditions) in the Base Properties is used in the Ideal Liquid density (Std Ideal Liq Mass Density) calculation. If a density is not supplied, the HYSYS estimated liquid mass density (at standard conditions) is used. Special treatment is given by the Oil Characterization feature to its hypocomponent such that the ideal density calculated for its streams match the assay, bulk property, and flow rate data supplied in the Oil Characterization Environment.

A.6.3 Formulation of Flow Rate Calculations

The various procedures used to calculate each of the available flow rates are detailed below, based on a known molar flow.

Molar Flow Rate

$$\text{Total Molar Flow} = \text{Molar Flow}_{\text{Stream}} \quad (\text{A.61})$$

Mass Flow

$$\text{Mass Flow} = \text{Total Molar Flow} \times MW_{\text{Stream}} \quad (\text{A.62})$$

Std Ideal Liq Vol Flow

Even if a stream is all vapour, it still has a Liq Volume flow, based upon the stream's Standard Ideal Liquid Mass density, whose calculation is detailed in the previous section.

This volumetric flow rate is calculated using the ideal density of the stream and thus is somewhat empirical in nature.

$$LiqVolFlow = \frac{Total\ Molar\ Flow \times MW_{Stream}}{Ideal\ Density_{Stream}} \quad (A.63)$$

Liq Vol Flow @ Std Cond

This volumetric flow rate is calculated using a rigorous density calculated at standard conditions, and reflects non-ideal mixing effects.

$$Std\ Liquid\ Volume\ Flow = \frac{Molar\ Flow \times MW}{Std\ Liq\ Density} \quad (A.64)$$

Actual Volume Flow

This volumetric flow rate is calculated using a rigorous liquid density calculation at the actual stream T and P conditions, and reflects non-ideal mixing effects.

$$Actual\ Volume\ Flow = \frac{Molar\ Flow \times MW}{Density} \quad (A.65)$$

Standard Gas Flow

Standard gas flow is based on the molar volume of an ideal gas at standard conditions. It is a direct conversion from the stream's molar flow rate, based on the following:

- Ideal Gas at 60°F and 1 atm occupies 379.46 ft³/lbmole
- Ideal Gas at 15°C and 1 atm occupies 23.644 m³/kgmole

Actual Gas Flow

This volumetric flow rate is calculated using a rigorous vapour density calculation at the actual stream T and P conditions, and reflects non-ideal mixing and compressibility effects.

$$\text{Actual Gas Flow} = \frac{\text{Molar Flow} \times \text{MW}}{\text{Density}} \quad (\text{A.66})$$

A.6.4 Volumetric Flow Rates as Specifications

If you require that the flow rate of your stream be specified based on actual density or standard density as opposed to Standard Ideal Mass Liquid density, you must use one of the following procedures:

Liq Vol Flow @ Std Cond

1. Specify the composition of your stream.
2. Use the standard ideal liquid mass density reported for the stream and calculate the corresponding mass flow rate either manually, or in the SpreadSheet.
3. Use this calculated mass flow as the specification for the stream.

Actual Liquid Volume Flow

1. Specify the composition and the flowing conditions (T and P) of your stream.
2. Use the density reported for the stream and calculate the corresponding mass flow rate either manually, or in our spreadsheet.
3. Use this calculated mass flow as the specification for the stream.

A.7 Flash Calculations

Specified variables can only be re-specified by you or through *Recycle Adjust*, or *SpreadSheet* operations. They do not change through any heat or material balance calculations.

Rigorous three phase calculations are performed for all equations of state and activity models with the exception of Wilson's equation, which only performs two phase vapour-liquid calculations. As with the Wilson Equation, the Amines and Steam property packages only support two phase equilibrium calculations.

HYSYS uses internal intelligence to determine when it can perform a flash calculation on a stream, and then what type of flash calculation needs to be performed on the stream. This is based completely on the degrees of freedom concept. Once the composition of a stream and two property variables are known, (vapour fraction, temperature, pressure, enthalpy or entropy) one of which must be either temperature or pressure, the thermodynamic state of the stream is defined. When HYSYS recognizes that a stream is thermodynamically defined, it performs the correct flash automatically in the background. You never have to instruct HYSYS to perform a flash calculation.

Property variables can either be specified by you or back-calculated from another unit operation. A specified variable is treated as an independent variable. All other stream properties are treated as dependent variables and are calculated by HYSYS.

If a flash calculation is performed on a stream, HYSYS knows all the property values of that stream, i.e., thermodynamic, physical and transport properties.

In this manner, HYSYS also recognizes when a stream is overspecified. For example, if you specify three stream properties plus composition, HYSYS prints out a warning message that an inconsistency exists for that stream. This also applies to streams where an inconsistency is created through HYSYS calculations.

For example, if a stream Temperature and Pressure are specified in a flowsheet, but HYSYS back-calculates a different temperature for that stream as a result of an enthalpy balance across a unit operation, HYSYS generates an Inconsistency message.

HYSYS automatically performs the appropriate flash calculation when it recognizes that sufficient stream information is known. This information is either specified by the user or calculated by an operation.

Depending on the known stream information, HYSYS performs one of the following flashes: T-P, T-VF, T-H, T-S, P-VF, P-H, or P-S.

A.7.1 T-P Flash Calculation

The independent variables for this type of flash calculation are the temperature and pressure of the system, while the dependent variables are the vapour fraction, enthalpy, and entropy.

See [Section 2.4.4 - Stability Test Tab](#) for options on how to instruct HYSYS to perform phase stability tests.

With the equations of state and activity models, rigorous calculations are performed to determine the co-existence of immiscible liquid phases and the resulting component distributions by minimization of the Gibbs free energy term. For vapour pressure models or the semi-empirical methods, the component distribution is based on the Kerosene solubility data (Figure 9A1.4 of the API Data Book).

If the mixture is single-phase at the specified conditions, the property package calculates the isothermal compressibility (dv/dp) to determine if the fluid behaves as a liquid or vapour. Fluids in the dense-phase region are assigned the properties of the phase that best represents their current state.

Use caution in specifying solids with systems that are otherwise all vapour. Small amounts of non-solids may appear in the "liquid" phase.

Note that material solids appear in the liquid phase of two-phase mixtures, and in the heavy (aqueous/slurry) phase of three-phase systems. Therefore, when a separator is solved using a T-P flash, the vapour phase is identical regardless of whether or not solids are present in the feed to the flash drum.

A.7.2 Vapour Fraction Flash

Vapour fraction and either temperature or pressure are the independent variables for this type of calculation. This class of calculation embodies all fixed quality points including bubble points (vapour pressure) and dew points.

To perform bubble point calculation on a stream of known composition, simply specify the Vapour Fraction of the stream as 0.0 and define the temperature or pressure at which the calculation is desired. For a dew point calculation, simply specify the Vapour Fraction of the stream as 1.0 and define the temperature or pressure at which the dew point calculation is desired. Like the other types of flash calculations, no initial estimates are required.

All of the solids appear in the liquid phase.

The vapour fraction is always shown in terms of the total number of moles. For example, the vapour fraction (VF) represents the fraction of vapour in the stream, while the fraction, $(1.0 - VF)$, represents all other phases in the stream (i.e., a single liquid, 2 liquids, a liquid and a solid).

Dew Points

Given a vapour fraction specification of 1.0 and either temperature or pressure, the property package calculates the other dependent variable (P or T). If temperature is the second independent variable, HYSYS calculates the dew point pressure. Likewise, if pressure is the independent variable, then the dew point temperature is calculated. Retrograde dew points may be calculated by specifying a vapour fraction of -1.0. It is important to note that a dew point that is retrograde with respect to temperature can be normal with respect to pressure and vice versa.

Bubble Points/Vapour Pressure

Vapour pressure and bubble point pressure are synonymous.

A vapour fraction specification of 0.0 defines a bubble point calculation. Given this specification and either temperature or pressure, the property package calculates the unknown T or P variable. As with the dew point calculation, if the temperature is known, HYSYS calculates the bubble point pressure and conversely, given the pressure, HYSYS calculates the bubble point temperature. For example, by fixing the temperature at 100°F, the resulting bubble point pressure is the true vapour pressure at 100°F.

Quality Points

HYSYS calculates the retrograde condition for the specified vapour quality if the vapour fraction is input as a negative number.

Bubble and dew points are special cases of quality point calculations. Temperatures or pressures can be calculated for any vapour quality between 0.0 and 1.0 by specifying the desired vapour fraction and the corresponding independent variable. If HYSYS displays an error when calculating vapour fraction, then this means that the specified vapour fraction doesn't exist under the given conditions, i.e., the specified pressure is above the cricondenbar, or the given temperature lies to the right of the cricondentherm on a standard P-T envelope.

A.7.3 Enthalpy Flash

If a specified amount of energy is to be added to a stream, this may be accomplished by specifying the energy stream into either a *Cooler/Heater* or *Balance* operation.

Given the enthalpy and either the temperature or pressure of a stream, the property package calculates the unknown dependent variables. Although the enthalpy of a stream cannot be specified directly, it often occurs as the second property variable as a result of energy balances around unit operations such as valves, heat exchangers and mixers.

If HYSYS responds with an error message, and cannot find the specified property (temperature or pressure), this probably means that an internally set temperature or pressure bound was encountered. Since these bounds are set at quite large values, there is generally some erroneous input that is directly or indirectly causing the problem, such as an impossible heat exchange.

A.7.4 Entropy Flash

Given the entropy and either the temperature or pressure of a stream, the property package calculates the unknown dependent variables.

A.7.5 Electrolyte Flash

Refer to the HYSYS OLI Interface Reference Guide for detailed information on electrolyte flash and aqueous thermodynamics.

The electrolyte stream flash differs from the HYSYS material stream flash to handle the complexities of speciation for aqueous electrolyte systems. The HYSYS OLI Interface package is an interface to the OLI Engine (OLI Systems) that enables simulations within HYSYS using the full functionality and capabilities of the OLI Engine for flowsheet simulation.

When the OLI_Electrolyte property package is associated with material streams, the streams exclusively become electrolyte material streams in the flowsheet. That is, the stream conducts a simultaneous phase and reaction equilibrium flash. For the model used and the reactions involved in the flash calculation, refer to the HYSYS OLI Interface reference guide.

An electrolyte material stream in HYSYS can perform the following type of flashes:

- TP Flash
- PH Flash
- TH Flash
- PV Flash
- TV Flash

Due to the involvement of reactions in the stream flash, the equilibrium stream flash may result in a different molar flow and composition from the specified value. Therefore, mass and energy are conserved for an electrolyte material stream against the HYSYS stream for mass, molar and energy balances.

Limitations exist in the HYSYS OLI Interface package in the calculation of the stream flash results. The calculation for the electrolyte flash results must fall within the following physical ranges to be valid.

- composition of H₂O in aqueous phase must be > 0.65.
- Temperature must be between 0 and 300°C.
- Pressure must be between 0 and 1500 atm.
- Ionic strength must be between 0 and 30 mole/kg-H₂O.

Refer to [Section 1.7 - Range of Applicability](#) of the HYSYS OLI Interface Reference Guide for more information on the limitations of the HEO models.

A.7.6 Handling of Water

Water is handled differently depending on the correlation being used. The PR and PRSV equations are enhanced to handle H₂O rigorously whereas the semi-empirical and vapour pressure models treat H₂O as a separate phase using steam table correlations.

In these correlations, H₂O is assumed to form an ideal, partially-miscible mixture with the hydrocarbons and its K value is computed from the relationship:

$$K_{\omega} = \frac{P^{\circ}}{(x_s P)} \quad (\text{A.67})$$

where: p° = vapour pressure of H_2O from Steam Tables

P = system pressure

x_s = solubility of H_2O in hydrocarbon liquid at saturation conditions.

The value for x_s is estimated by using the solubility data for kerosene as shown in Figure 9A1.4 of the API Data Book¹⁹. This approach is generally adequate when working with heavy hydrocarbon systems. However, it is not recommended for gas systems.

For three phase systems, only the PR and PRSV property package and Activity Models allow components other than H_2O in the second liquid phase. Special considerations are given when dealing with the solubilities of glycols and CH_3OH . For acid gas systems, a temperature dependent interaction parameter was used to match the solubility of the acid component in the water phase.

The PR equation considers the solubility of hydrocarbons in H_2O , but this value may be somewhat low. The reason for this is that a significantly different interaction parameter must be supplied for cubic equations of state to match the composition of hydrocarbons in the water phase as opposed to the H_2O composition in the hydrocarbon phase. For the PR equation of state, the latter case was assumed more critical. The second binary interaction parameter in the PRSV equation allows for an improved solubility prediction in the alternate phase.

With the activity coefficient models, the limited mutual solubility of H_2O and hydrocarbons in each phase can be taken into account by implementing the insolubility option (please refer to [Section A.3.2 - Activity Models](#)). HYSYS generates, upon request, interaction parameters for each activity model (with the exception of the Wilson equation) that are fitted to match the solubility of H_2O in the liquid hydrocarbon phase and hydrocarbons in the aqueous phase based on the solubility data referred to in that section.

The Peng-Robinson and SRK property packages will always force the water rich phase into the heavy liquid phase of a three phase stream. As such, the aqueous phase is always forced out of the bottom of a three phase separator, even if a light liquid phase (hydrocarbon rich) does not exist. Solids are always carried in the second liquid phase.

A.7.7 Supercritical Handling

HYSYS reports a vapor fraction of zero or one, for a stream under supercritical conditions. Theoretically, this value doesn't have any physical meaning for a supercritical fluid, since there is no distinction of liquid or vapor phases in a supercritical region. However, it is important to determine if a supercritical fluid is liquid-like or a vapor-like fluid. This is because some of the properties reported in HYSYS are calculated using certain sets of specific phase models. In other words, phase identification has to be carried out in order to decide which model to use to calculate these properties.

In HYSYS, all flash results go through a phase order function to identify the phase type. Different packages have their own different order.

For example, the following criteria are used to identify phase types for the PR, SRK, SourPR, and Sour SRK cubic equations of state at supercritical region:

1. If the compressibility factor (Z) is greater than 0.3, and the isothermal compressibility factor (β) is greater than 0.75, a vapor fraction of 1.0 is assigned to the stream.
2. If Z is greater than 0.75 and the sum of composition of light compounds ($NBP < 230K$) is greater than the sum of composition of heavy compounds, a vapor fraction of 1.0 is assigned to the stream.

Otherwise, vapor fraction of 0 is assigned to the stream and liquid correlations are used.

A.7.8 Solids

HYSYS does not check for solid phase formation of pure components within the flash calculations, however, incipient solid formation conditions for CO₂ and hydrates can be predicted with the Utility Package (for more information, refer to [Chapter 14 - Utilities](#) of the [Operations Guide](#)).

Solid materials such as catalyst or coke can be handled as user-defined, solid type components. The HYSYS property package takes this type of component into account in the calculation of the following stream variables: stream total flow rate and composition (molar, mass and volume), vapour fraction, entropy, enthalpy, specific heat, density, molecular weight, compressibility factor, and the various critical properties. Transport properties are computed on a solids-free basis. Note that solids are always carried in the second liquid phase, i.e., the water rich phase.

Solids do not participate in vapour-liquid equilibrium (VLE) calculations. Their vapour pressure is taken as zero. However, since solids do have an enthalpy contribution, they have an effect on heat balance calculations. Thus, while the results of a Temperature flash are the same whether or not such components are present, an Enthalpy flash is affected by the presence of solids.

A solid material component is entered as a hypothetical component in HYSYS. See [Chapter 3 - Hypotheticals](#) for more information on Hypotheticals.

A.7.9 Stream Information

When a flash calculation occurs for a stream, the information that is returned depends on the phases present within the stream. The following table shows the stream properties that are calculated for each phase:

F - Feed
V - Vapour
L - Liquid
S - Solid

Steam Property	Applicable Phases ^A			
Vapour Phase Mole Fraction	F	V	L	S
Vapour Phase Mass Fraction	F	V	L	S
Vapour Phase Volume Fraction	F	V	L	S
Temperature	F	V	L	S
Pressure	F	V	L	S
Flow	F	V	L	S
Mass Flow	F	V	L	S
Liquid Volume Flow (Std, Ideal)	F	V	L	S
Volume Flow	F	V	L	S
Std. Gas Flow	F	V	L	S
Std. Volume Flow	F		L	S
Energy	F	V	L	S
Molar Enthalpy	F	V	L	S
Mass Enthalpy	F	V	L	S
Molar Entropy	F	V	L	S
Mass Entropy	F	V	L	S
Molar Volume	F	V	L	S
Molar Density	F	V	L	S
Mass Density	F	V	L	S
Std. Liquid Mass Density	F ^D		L	S
Molar Heat Capacity	F	V	L	S
Mass Heat Capacity	F	V	L	S
CP/CV	F	V	L	S
Thermal Conductivity	F ^{B,D}	V	L	
Viscosity	F ^{B,D}	V	L	
Kinematic Viscosity	F ^{B,D}	V	L	
Surface Tension	F ^B		L	
Molecular Weight	F	V	L	S
Z Factor	F ^B	V	L	S
Air SG	F ^B	V		
Watson (UOP) K Value	F	V	L	S
Component Mole Fraction	F	V	L	S

Steam Property	Applicable Phases ^A			
Component Mass Fraction	F	V	L	S
Component Volume Fraction	F	V	L	S
Component Molar Flow	F	V	L	S
Component Mass Flow	F	V	L	S
Component Volume Flow	F	V	L	S
K Value (y/x)				
Lower Heating Value				
Mass Lower Heating Value				
Molar Liquid Fraction	F	V	L	S
Molar Light Liquid Fraction	F	V	L	S
Molar Heavy Liquid Fraction	F	V	L	S
Molar Heat of Vapourization	F ^C	V	L	
Mass Heat of Vapourization	F ^C	V	L	
Partial Pressure of CO ₂	F	V	L	S

^AStream phases:

- F - Feed
- V - Vapour
- L - Liquid
- S - Solid

^BPhysical property queries are allowed on the feed phase of single phase streams.

^CPhysical property queries are allowed on the feed phase only for streams containing vapour and/or liquid phases.

^DPhysical property queries are allowed on the feed phase of liquid streams with more than one liquid phase.

A.8 References

- ¹ Peng, D. Y. and Robinson, D. B., "A Two Constant Equation of State", I.E.C. Fundamentals, 15, pp. 59-64 (1976).
- ² Soave, G., Chem Engr. Sci., 27, No. 6, p. 1197 (1972).
- ³ Knapp, H., et al., "Vapor-Liquid Equilibria for Mixtures of Low Boiling Substances", Chemistry Data Series Vol. VI, DECHEMA, 1989.
- ⁴ Kabadi, V.N., and Danner, R.P. A Modified Soave-Redlich-Kwong Equation of State for Water-Hydrocarbon Phase Equilibria, Ind. Eng. Chem. Process Des. Dev. 1985, Volume 24, No. 3, pp 537-541.
- ⁵ Stryjek, R., Vera, J.H., J. Can. Chem. Eng., 64, p. 334, April 1986.
- ⁶ API Publication 955, A New Correlation of NH₃, CO₂ and H₂S Volatility Data From Aqueous Sour Water Systems, March 1978.
- ⁷ Zudkevitch, D., Joffe, J. "Correlation and Prediction of Vapor-Liquid Equilibria with the Redlich-Kwong Equation of State", AIChE Journal, Volume 16, No. 1, January pp. 112-119.
- ⁸ Reid, C.R., Prausnitz, J.M. and Sherwood, T.K., "The Properties of Gases and Liquids", McGraw-Hill Book Company, 1977.
- ⁹ Prausnitz, J.M., Lichtenthaler, R.N., Azevedo, E.G., "Molecular Thermodynamics of Fluid Phase Equilibria", 2nd. Ed., McGraw-Hill, Inc. 1986.
- ¹⁰ Chao, K. D. and Seader, J. D., A.I.Ch.E. Journal, pp. 598-605, December 1961.
- ¹¹ Grayson, H. G. and Streed, G. W., "Vapour-Liquid Equilibria for High Temperature, High Pressure Systems", 6th World Petroleum Congress, West Germany, June 1963.
- ¹² Jacobsen, R.T and Stewart, R.B., 1973. "Thermodynamic Properties of Nitrogen Including Liquid and Vapour Phases from 63 K to 2000K with Pressure to 10 000 Bar." J. Phys. Chem. Reference Data, 2: 757-790.
- ¹³ Hankinson, R.W. and Thompson, G.H., A.I.Ch.E. Journal, 25, No. 4, p. 653 (1979).
- ¹⁴ Ely, J.F. and Hanley, H.J.M., "A Computer Program for the Prediction of Viscosity and Thermal Conductivity in Hydrocarbon Mixtures", NBS Technical Note 1039.
- ¹⁵ Twu, C.H., I.E.C. Proc Des & Dev, 24, p. 1287 (1985).
- ¹⁶ Reid, R.C., Prausnitz, J.M., Poling, B.E., "The Properties of Gases & Liquids", McGraw-Hill, Inc., 1987.

- ¹⁷Woelflin, W., "Viscosity of Crude-Oil Emulsions", presented at the spring meeting, Pacific Coast District, Division of Production, Los Angeles, Calif., Mar. 10, 1942.
- ¹⁸Gambill, W.R., Chem. Eng., March 9, 1959.
- ¹⁹API Technical Data Book, Petroleum Refining, Fig. 9A1.4, p. 9-15, 5th Edition (1978).
- ²⁰Keenan, J. H. and Keyes, F. G., Thermodynamic Properties of Steam, Wiley and Sons (1959).
- ²¹Perry, R. H.; Green, D. W.; "Perry's Chemical Engineers' Handbook Sixth Edition", McGraw-Hill Inc., (1984).
- ²²Passut, C. A.; Danner, R. P., "Development of a Four-Parameter Corresponding States Method: Vapour Pressure Prediction", Thermodynamics - Data and Correlations, AIChE Symposium Series; p. 30-36, No. 140, Vol. 70.

B Petroleum Methods/ Correlations

B.1 Introduction	2
B.2 Characterization Method	2
B.2.1 Generate a Full Set of Working Curves	3
B.2.2 Light Ends Analysis.....	4
B.2.3 Auto Calculate Light Ends.....	6
B.2.4 Determine TBP Cutpoint Temperatures	7
B.2.5 Graphically Determine Component Properties	8
B.2.6 Calculate Component Critical Properties	8
B.2.7 Correlations.....	9
B.3 References.....	10

B.1 Introduction

This appendix is a supplement to [Chapter 4 - HYSYS Oil Manager](#). Included in this appendix is the general procedure used by HYSYS to characterize an oil and a list of correlations used in the Oil Manager.

B.2 Characterization Method

The procedure HYSYS uses to convert your assay data into a series of petroleum hypocomponent involves four major internal characterization steps:

1. Based on your input curves, HYSYS calculates a detailed set of full range Working Curves that include the true boiling point (TBP) temperature, molecular weight, density and viscosity behaviour.
2. Next, by using either a default or user-supplied set of cutpoint temperatures, the corresponding fraction for each hypocomponent is determined from the TBP working curve.
3. The normal boiling point (NBP), molecular weight, density and viscosity of each hypocomponent are graphically determined from the working curves.
4. For each hypocomponent, HYSYS calculates the remaining critical and physical properties from designated correlations, based upon the component's NBP, molecular weight, and density.

Knowledge of the four phases of the characterization process provide a better understanding of how your input data influences the final outcome of your characterization. The following sections detail each step of the calculation.

B.2.1 Generate a Full Set of Working Curves

To ensure accuracy, a true boiling point (TBP) curve and associated molecular weight, density, and viscosity property curves are required for the characterization calculations. HYSYS takes whatever input curves you have supplied, and interpolates and extrapolates them as necessary to complete the range from 0 to 100%. These full range curves are referred to as the working curves.

If you supply an ASTM D86, ASTM D1160, or EFV distillation curve as input, it is automatically converted to a TBP distillation curve. On the other hand, if you do not have any distillation data, supplying two of the three bulk properties (molecular weight, density, or Watson (UOP) K factor) allows HYSYS to calculate an *average*¹ TBP distillation curve.

Physical property curves that were not supplied are calculated from default correlations designed to model a wide variety of oils, including condensates, crude oils, petroleum fractions, and coal-tar liquids. If you supply a bulk molecular weight or bulk density, the corresponding physical property curve (either user-supplied or generated) is smoothed and adjusted such that the overall property is matched. A typical TBP curve is illustrated below.

Default values of the IBP and FBP can be changed on the Boiling Ranges view. Refer to [Section 4.4 - Oil Characterization View](#).

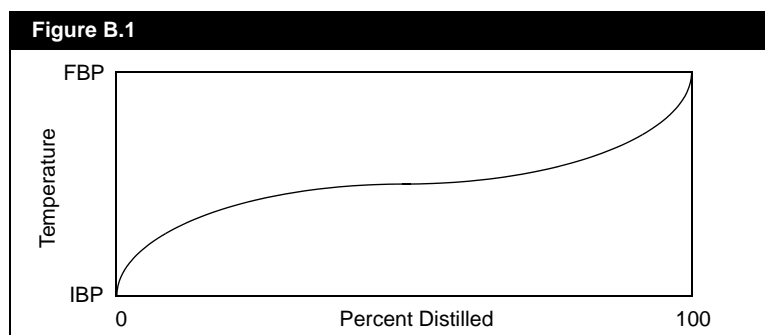

B.2.2 Light Ends Analysis

HYSYS uses your Light Ends data to either define or replace the low boiling portion of your TBP, ASTM D86 or ASTM D1160 curve with discrete pure components. HYSYS does not require that you match the highest boiling point light-end with the lowest boiling point temperature on the TBP curve.

Using the sample Light Ends analysis shown here, HYSYS replaces the first portion of the TBP working curve to the assay percentage just past the boiling point of n-pentane (approximately 95°F or 36°C) or 11.3 vol% (the cumulative light ends total), whichever is greater. The new TBP curve would include the Light Ends Free portion of the original sample beginning at 0% distilled with the associated IBP representing the remaining portion of the original sample.

Three possible Light Ends/Assay situations can exist as depicted in the next three figures. In the following figures:

- Point A represents the boiling point of the heaviest light-end, n-Pentane in this example.
- Point B represents the temperature at which the total Light Ends percentage intersects the TBP working curve.

If points A and B coincide exactly as shown in [Figure B.2](#), HYSYS assigns the TBP working curve's IBP equal to the boiling point of the heaviest light end and normalizes the remaining portion of the TBP curve with the light ends removed. All points that lie below point B on the curve are eliminated.

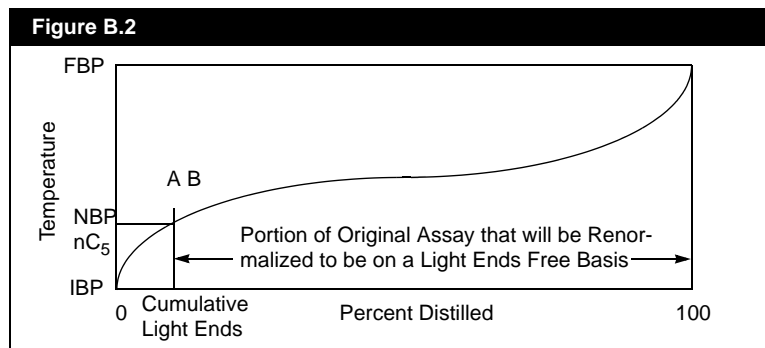
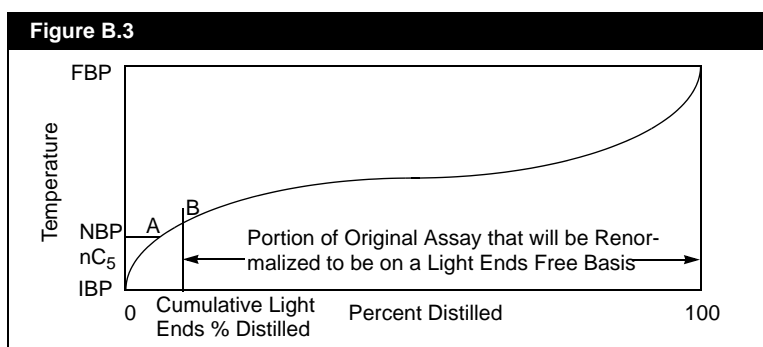

Figure B.3 depicts the situation that may arise from inconsistent data or from a poor extrapolation of the IBP. These situations are corrected by assuming that the Light Ends analysis is correct and that the error exists in the internal TBP curve. In the following figure, Point A (boiling point of the heaviest light end component) lies below Point B (internal TBP curve temperature associated with your cumulative light ends percentage) on the internal TBP working curve. HYSYS replaces point B (the Light Ends free IBP) by a point that uses the cumulative light ends percentage and the normal boiling point of the heaviest light end component. The Light Ends free portion of the curve is smoothed before normalizing.



The next figure shows the boiling point of the heaviest light-end occurring at an assay percentage greater than the cumulative Light Ends total. HYSYS corrects this situation by successively eliminating TBP working curve points from point B up to the first temperature point greater than the heaviest light end temperature (Point A).

B.2.4 Determine TBP Cutpoint Temperatures

You may specify the hypocomponent breakdown by supplying a number of cutpoint temperatures and the corresponding number of cuts for each temperature range, or you may let HYSYS calculate an optimal set of cutpoints for you based upon the overall number of hypocomponent you have designated. The characterization process then uses its TBP working curve and the specified set of TBP cutpoints to determine the fraction of each hypocomponent on the input curve basis.

In [Figure B.6](#), four components are generated from the TBP curve using five TBP cutpoints of equal temperature increment. Refer to [Section 4.6 - Hypocomponent Generation](#) for more details.

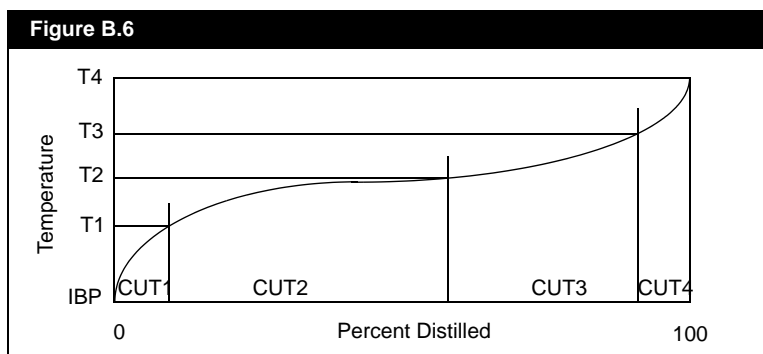

B.2.5 Graphically Determine Component Properties

After the cutpoints and the fraction of each hypocomponent are known, the average boiling point may be determined. This is the normal boiling point (NBP), which is calculated for each component by equalizing the areas between the TBP curve and a horizontal line representing the NBP temperature. This is shown in the figure below, with the grey areas representing the equalized areas. The average molecular weight, density, and viscosity of each hypocomponent are subsequently calculated from the corresponding smoothed working curves for molecular weight, density and viscosity.

Figure B.7

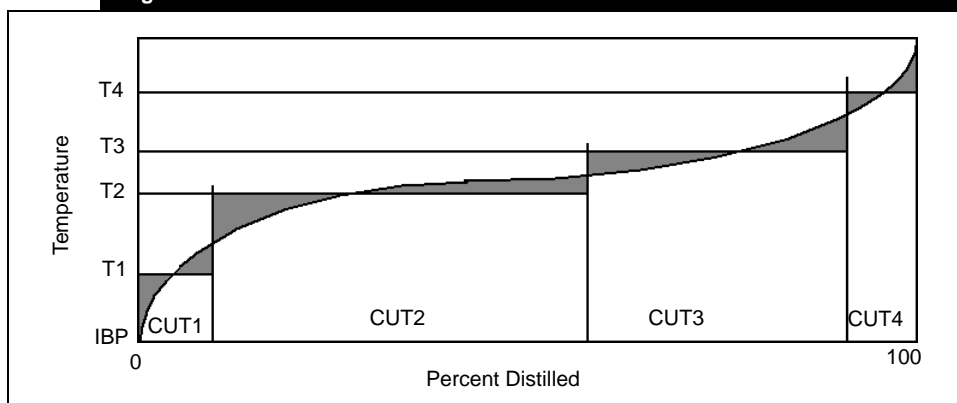

B.2.6 Calculate Component Critical Properties

Knowing the normal boiling point, molecular weight, and density enables HYSYS to calculate the remaining physical and thermodynamic properties necessary to completely define the petroleum hypocomponent. These properties are estimated for each hypocomponent using default or user-selected correlations as outlined in [Section B.2.7 - Correlations](#).

B.2.7 Correlations

The range of applicability for the critical property correlations are explained below:

Critical Property Correlation	Range of Applicability
Lee-Kesler	These equations yield nearly identical results to those obtained using the graphical correlations found in the API Data Book for boiling temperatures below 1250°F (677°C). The equations are modified to extend beyond this range, but an upper limit is not given by the authors.
Cavett	The author does not present any reference as to which data were used for the development of the correlations or their limitations. Experience has proven these correlations to produce very good results for fractions whose API gravity is greater than zero or for highly aromatic and naphthenic fractions such as coal tar liquids.
Riazi-Daubert	In the boiling point range 0 - 602°F (-18 - 317°C), these correlations perform slightly better than other methods. Their most serious drawback is the limitation of the boiling point to 855°F (457°C) for the calculation of critical pressure and molecular weight.
Nokay	Limitations for these correlations are not presented in the original publications. The critical temperature and molecular weight correlations are particularly good for highly aromatic or naphthenic systems as shown in a paper by Newman, "Correlations Evaluated for Coal Tar Liquids".
Roess	The main limitation of these correlations is that they should not be used for fractions heavier than C ₂₀ (650°F, 343°C). They highly underestimate critical temperatures for heavier fractions and should not be used for heavy oil applications.
Edmister	These equations are very accurate for pure components, but are restricted to condensate systems with a limited amount of isomers. Edmister acentric factors tend to be lower than Lee-Kesler values for fractions heavier than C ₂₀ (650°F, 343°C). It is recommended that application of the Edmister equation be restricted to the range below C ₂₀ .
Bergman	These correlations were developed for lean gases and gas condensates with relatively light fractions, thereby limiting their general applicability to systems with carbon numbers less than C ₁₅ .
Spencer-Daubert	This family of correlations is a modification of the original Nokay equations with a slightly extended range of applicability.
Rowe	These equations were presented for estimating boiling point, critical pressure and critical temperature of paraffin hydrocarbons. Carbon number, which is used as the only correlating variable, limits the range of applicability to lighter paraffinic systems.
Standing	The data of Matthews, Roland and Katz was used to develop these correlations. Molecular weight and specific gravity are the correlating variables. Although Standing claims the correlations are for C ₇₊ fractions, they appear to be valid for narrower boiling point cuts as well. The correlations should be used with caution for fractions heavier than C ₂₅ (841°F, 450°C).
Lydersen	These correlations are based on the PNA (Paraffin/Naphthene/Aromatic) concept similar to Peng-Robinson PNA.

Critical Property Correlation	Range of Applicability
Bergman	This method is limited to components whose gravity does not exceed 0.875 because of the form of the PNA equations. Acentric factors for fractions heavier than C ₂₀ are considerably higher than those estimated from either the Edmister or Lee-Kesler equation. These correlations are included primarily for completeness and should not be used for fluids containing fractions heavier than C ₂₀ .
Yarborough	This method is only for use in the prediction of specific gravity of hydrocarbon components. Carbon number and aromaticity are the correlating variables for this equation. The Yarborough method assumes that the C ₇₊ molecular weight and specific gravity are measured. It also assumes that the mole fractions are measured from chromatographic analysis (paraffin molecular weights are assumed to convert weight to mole fractions).
Katz-Firoozabadi	These correlations are only available for the prediction of molecular weight and specific gravity. Normal boiling point is the only correlating variable and application should be restricted to hydrocarbons less than C ₄₅ .
Mathur	Limitations for these correlations are not published by the author. These equations produce excellent results for highly aromatic mixtures such as coal-tar liquids, but are not rigorously examined for highly paraffinic systems.
Penn State	These correlations are similar to Riazi-Daubert correlations and should have approximately the same limitations.
Aspen	These correlations yield results quite close to the Lee-Kesler equations, but tend to produce better results for aromatic systems. Limitations for these equations are not available, but the Lee-Kesler limitations should provide a good guide.
Hariu Sage	These correlations were developed for estimating molecular weight from boiling point and specific gravity utilizing the Watson Characterization Factor, Kw. It provides reasonable extrapolation to boiling points greater than 1500°F (816°C) and is more accurate than the Lee-Kesler molecular weight correlation.

B.3 References

- ¹ Whitson, C. H., "Characterizing Hydrocarbon Plus Fractions", Society of Petroleum Engineers Journal, August 1983.

C Amines Property Package

C.1 Amines Property Package	2
C.2 Non-Equilibrium Stage Model	5
C.3 Stage Efficiency	7
C.3.1 Non-Equilibrium Stage Model.....	8
C.4 Equilibrium Solubility	9
C.4.1 Kent & Eisenberg Model.....	9
C.4.2 Li-Mather Electrolyte Model.....	12
C.5 Phase Enthalpy	18
C.6 Simulation of Amine Plant Flowsheets	19
C.6.1 Solving the Columns.....	19
C.6.2 Converging the Contactor.....	20
C.6.3 Converging the Regenerator	21
C.6.4 Recycle Convergence.....	21
C.6.5 Operating Conditions.....	22
C.7 Program Limitations	23
C.7.1 Range of Applicability	23
C.8 References	24

C.1 Amines Property Package

The Amines Property Package is a special option available for HYSYS. For more information on this option or get information on other HYSYS additions please contact your Hyprotech Agent.

The removal of acid gases such as hydrogen sulphide (H₂S) and carbon dioxide (CO₂) from process gas streams is often required in natural gas plants and in oil refineries. There are many treating processes available. However, no single process is ideal for all applications. The initial selection of a particular process may be based on feed parameters such as composition, pressure, temperature and the nature of the impurities, as well as product specifications.

Final selection is ultimately based on process economics, reliability, versatility and environmental constraints. Clearly the selection procedure is not a trivial matter and any tool that provides a reliable mechanism for process design is highly desirable.

Acid gas removal processes using absorption technology and chemical solvents are popular, particularly those using aqueous solutions of alkanolamines. The Amines Property Package is a special property package designed to aid in the modeling of alkanolamine treating units in which H₂S and CO₂ are removed from gas streams. The Property Package contains data to model the absorption/desorption process where aqueous solutions of single amines - monoethanolamine (MEA), diethanolamine (DEA), methyldiethanolamine (MDEA), triethanolamine (TEA), 2,2'-hydroxy-aminoethylether (DGA), or diisopropanolamine (DIPA) and aqueous solutions of blended amines - MEA/MDEA or DEA/MDEA are used.

Figure C.1 shows the conventional process configuration for a gas treating system that uses aqueous alkanolamine solutions. The sour gas feed is contacted with amine solution counter-currently in a trayed or packed absorber. Acid gases are absorbed into the solvent that is then heated and fed to the top of the regeneration tower. Stripping steam produced by the reboiler causes the acid gases to desorb from the amine solution as it passes down the column. A condenser provides reflux and the acid gases are recovered overhead as a vapour product. Lean amine solution is cooled and recycled back to the absorber. A partially stripped, semi-lean amine stream may be withdrawn from the regenerator and fed to the absorber in the split-flow modification to the conventional plant flowsheet. A three-phase separator or flash tank may be installed at the outlet of the absorber to permit the recovery of dissolved and entrained hydrocarbons and to reduce the hydrocarbon content of the acid gas product.

Figure C.1

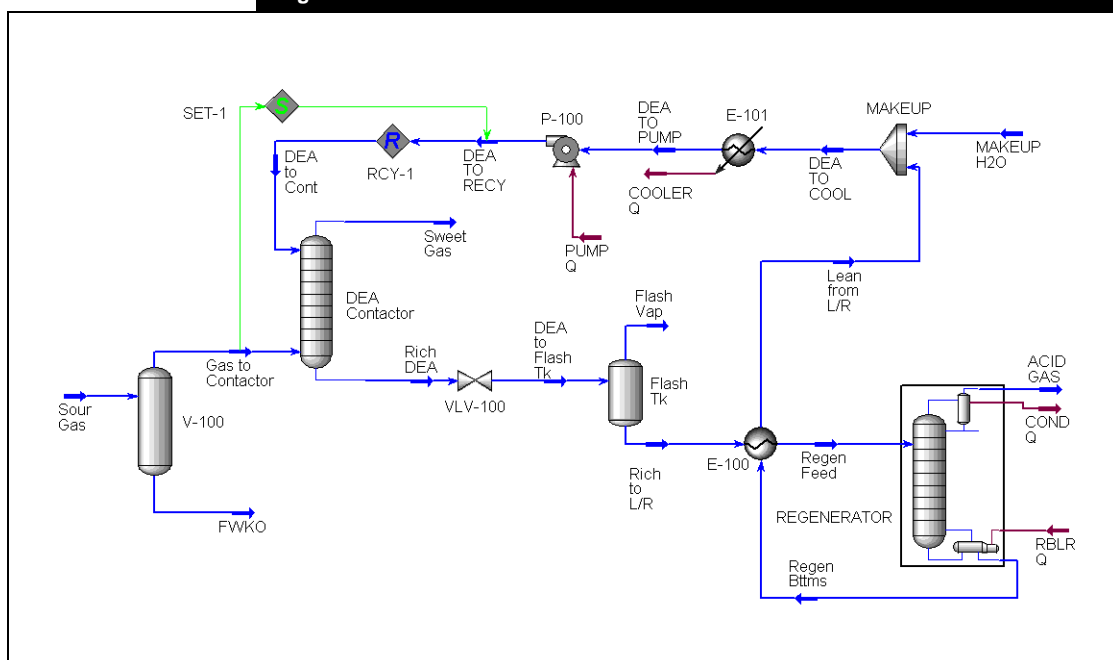

The design of amine treating units involves the selection of the following:

- the process configuration
- the amine type and concentration
- the solution circulation rate
- the reboiler heat requirements
- the operating pressures and temperatures.

The mechanical tray design and the number of stages in the contactor are known to affect the process performance and are particularly important in selective absorption applications.

Amine treating units were designed in the past using hand calculations and operating experience. Design conditions were typically chosen within a conservative range to cover the deficiencies in the data used in the hand calculations. Simulation is one means of obtaining values for the key design variables in the process, and is generally used to confirm the initial design obtained by the above methods.

Rules-of-thumb do not exist for the design of selective absorption applications since operating experience is limited. Furthermore, the process is generally controlled by reaction kinetics and cannot be designed on the basis of chemical equilibrium alone. The simulation program must be relied upon as a predictive tool in these cases.

The AMSIM program uses technology developed by DB Robinson & Associates Ltd. to model the equilibrium solubility of acid gases in aqueous amine solutions. A new nonequilibrium stage model which is based on the stage efficiency concept is used to simulate the performance of contactors and regenerators. A list of reference articles on the research leading to the development of AMSIM can be found at the end of this section. The best data known to exist is used to determine the component properties in the AMSIM databank.

The AMSIM models is designed for one amine or two amines. When two amines are selected, the Amines property package expects both amines to have a composition or both amines to be zero. You cannot specify one amine composition to be greater than zero and the other to be equal to zero. It is suggested that instead of specifying one amine to be zero, input a very small composition value for said amine.

C.2 Non-Equilibrium Stage Model

A non-equilibrium stage model developed to simulate the multi-component multistage mass transfer process encountered in an amine treating unit is used in the Amines Property Package.

The generalized stage model shown in [Figure C.2](#) gives the flow geometry and nomenclature for an individual stage in a column. The fundamental concept used is that the rate of absorption/desorption of acid gases to/from the amine solution must be considered as a mass-transfer rate process. This rate process depends on the equilibrium and kinetic parameters that describe the acid gas/amine system.

The model incorporates a modified Murphree-type vapour efficiency to account for the varying mass-transfer rates of individual acid gas components. The acid gas stage efficiencies are, in turn, functions of mass-transfer coefficients and the mechanical design of the tray.

When the generalized stage model is extended to the multistage case, the resulting column flow geometry and nomenclature is shown in [Figure C.2](#). The resulting set of balance equations that characterize the multistage unit are given in [Section C.4 - Equilibrium Solubility](#). This set of equations must be solved for each column in the flowsheet. A modified Newton-Raphson method is used to solve the rigorous non-linear stage equations simultaneously for temperature, composition and phase rates on each stage in a column.

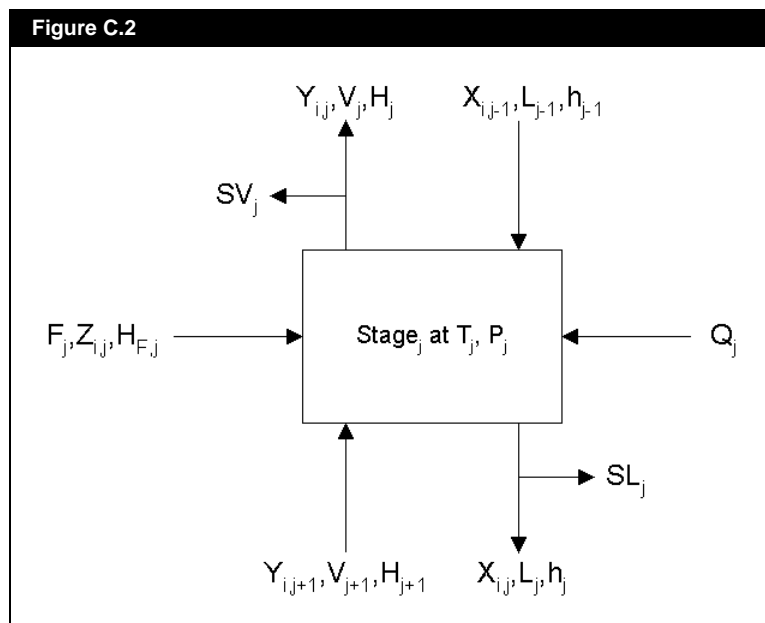

C.3 Stage Efficiency

The stage efficiency as defined under the Amines property package option is given by:

$$\eta = \frac{(V_j + SV_j)Y_j - V_{j+1}Y_{ij+1}}{(V_j + SV_j)K_{1j}X_{ij} - V_{j+1}Y_{ij+1}} \quad (\text{C.1})$$

where: η = Stage efficiency

i = Component number

j = Stage number

K = Equilibrium ratio

V = Molar flow rate of vapour

X = Mole fraction in liquid phase

Y = Mole fraction in vapour phase

The stage efficiency is a function of the kinetic rate constants for the reactions between each acid gas and the amine, the physico-chemical properties of the amine solution, the pressure, temperature and the mechanical tray design variables such as tray diameter, weir height and weir length.

You may specify the stage efficiencies or have them calculated in HYSYS.

If the Amines option is selected, HYSYS always uses stage-component efficiencies. Note that the efficiencies used are only for H₂S and CO₂ components. If the efficiencies are not specified for the column, HYSYS calculates efficiencies based on the tray dimensions specified in the Amines page of the Column view. If no tray dimensions are specified, HYSYS uses the default tray dimensions to calculate the stage efficiencies. These are real stages, not ideal stages.

C.3.1 Non-Equilibrium Stage Model

Overall Material Balance

$$F_j + L_{j-1} - (L_j + SL_j) - (V_j + SV_j) = 0 \quad (\text{C.2})$$

Component Material Balance

$$F_j z_{ij} + L_{j-1} x_{ij-1} + V_{j+1} Y_{ij+1} - (L_j + SL_j) x_{ij} - (V_j + SV_j) y_{ij} = 0 \quad (\text{C.3})$$

Energy Balance

$$F_j H_{Fj} + Q_j + L_{j-1} h_{j-1} + V_{j+1} H_{j+1} - (L_j + SL_j) h_j - (V_j + SV_j) H_j = 0 \quad (\text{C.4})$$

Equilibrium Relationship

$$\eta_{ij} K_{ij} x_{ij} (V_j + SV_j) - (V_j + SV_j) y_{ij} + (1 - \eta_{ij}) V_{j+1} y_{ij+1} = 0 \quad (\text{C.5})$$

Summation Equation

$$\sum y_{ij} - 1.0 = 0 \quad (\text{C.6})$$

C.4 Equilibrium Solubility

C.4.1 Kent & Eisenberg Model

A model based on the Kent and Eisenberg approach is used to correlate the equilibrium solubility of acid gases in the amine solutions. The reference articles contain experimental data that were used to validate the solubility model. Additional unpublished data for DEA, MDEA, MEA/MDEA, and DEA/MDEA systems have also been incorporated.

Improvements were made to the model to extend the reliable range to mole loadings between 0.0001 and 1.2. A proprietary model was developed to predict the solubility of acid gas mixtures in tertiary amine solutions. Solubilities of inert components such as hydrocarbons are modeled using a Henry's constant adjusted for ionic strength effects.

The prediction of equilibrium ratios or K-values involves the simultaneous solution of a set of non-linear equations that describe the chemical and phase equilibria and the electroneutrality and mass balance of the electrolytes in the aqueous phase. These equations are provided below. The model is used to interpolate and extrapolate the available experimental solubility data in the Amines Property Package. For tertiary amines that do not form carbamate, the equations involving that ionic species are eliminated from the model.

These equations are shown as follows:

Chemical Reactions	
$R_1R_2NH + H_2O \Leftrightarrow R_1R_2NH_2^+ + OH^-$	(C.7)
$R_1R_2R_3N + H_2O \Leftrightarrow R_1R_2R_3NH^+ + OH^-$	(C.8)
$R_1R_2NH + CO_2 \Leftrightarrow R_1R_2NCOO^- + H^+$	(C.9)
$H_2O \Leftrightarrow H^+ + OH^-$	(C.10)

Chemical Reactions

$H_2S \Leftrightarrow H^+ + HS^-$	(C.11)
$CO_2 + H_2O \Leftrightarrow H^+ + HCO_3^-$	(C.12)
$HS^- \Leftrightarrow H^+ + S^{=}$	(C.13)
$HCO_3^- \Leftrightarrow H^+ + CO_3^{=}$	(C.14)

Equilibrium Relations

$K_1 = \frac{[H^+][R_1R_2NH]}{[R_1R_2NH_2^+]}$	(C.15)
$K_2 = \frac{[H^+][R_1R_2R_3N]}{[R_1R_2R_3NH^+]}$	(C.16)
$K_3 = \frac{[HCO_3^-][R_1R_2NH]}{[R_1R_2NCOO^-]}$	(C.17)
$K_4 = \frac{[H^+][OH^-]}{[H_2O]}$	(C.18)
$K_5 = \frac{[H^+][HS^-]}{[H_2S]}$	(C.19)
$K_6 = \frac{[H^+][HCO_3^-]}{[CO_2][H_2O]}$	(C.20)
$K_7 = \frac{[H^+][S^{=}]}{[HS^-]}$	(C.21)
$K_8 = \frac{[H^+][CO_3^{=}]}{[HCO_3^-]}$	(C.22)

Phase Equilibria

$$y_{H_2S} \phi_{H_2S}^V P = H_{H_2S} [H_2S] \quad (C.23)$$

$$y_{CO_2} \phi_{CO_2}^V P = H_{CO_2} [CO_2] \quad (C.24)$$

Charge Balance

$$[H^+] + [R_1R_2NH_2^+] + [R_1R_2R_3NH^+] = [OH^-] + [R_1R_2NCOO^-] + [HCO_3^-] + [HS^-] + 2[CO_3^{2-}] + 2[S^{2-}] \quad (C.25)$$

Mass Balance

$$C_{1,2-amine} = [R_1R_2NH] + [R_1R_2NH_2^+] + [R_1R_2NCOO^-] \quad (C.26)$$

$$C_{3-amine} = [R_1R_2R_3N] + [R_1R_2R_3NH^+] \quad (C.27)$$

$$C_{CO_2} = (C_{1,2-amine} + C_{3-amine}) \alpha_{CO_2} = [CO_2] + [R_1R_2NCOO^-] + [HCO_3^-] + [CO_3^{2-}] \quad (C.28)$$

$$C_{H_2S} = (C_{1,2-amine} + C_{3-amine}) \alpha_{H_2S} = [H_2S] + [HS^-] + [S^{2-}] \quad (C.29)$$

The fugacity coefficient of the molecular species is calculated by the Peng-Robinson equation of state:

$$p = \frac{RT}{v-b} - \frac{a(T)}{v(v+b) + b(v-b)} \quad (\text{C.30})$$

where:

$$a = \alpha(0.45724)R^2T_c^2/P_c \quad (\text{C.31})$$

$$b = (0.07780)RT_c/P_c \quad (\text{C.32})$$

The temperature-dependent quantity α has the following form.

$$\alpha^{1/2} = 1 + \alpha_1(1 - \sqrt{T_r}) + \alpha_2(1 - T_r)(0.7 - T_r) \quad (\text{C.33})$$

The parameters α_1 and α_2 are substance-dependent and are determined through rigorous regressions against reliable data.

For mixtures, equation parameters a and b are estimated by the following mixing rules.

$$a = \sum_i \sum_j x_i x_j (a_i a_j)^{0.5} (1 - k_{ij}) \quad (\text{C.34})$$

$$b = \sum_i \sum_j x_i x_j \left(\frac{b_i + b_j}{2} \right) (1 - l_{ij}) \quad (\text{C.35})$$

C.4.2 Li-Mather Electrolyte Model

The Amines property package is modified to simulate three phase behaviour. For the three phase simulation, the K values from the Peng-Robinson property package were combined with the K values from the Amines LLE and VLE package.

The Li-Mather model shows a strong predictive capability over a wide range of temperatures, pressures, acid gas loadings, and amine concentrations. AMSIM is capable of simulating processes with blended solvents made up of any two of six principle amines (MEA, DEA, MDEA, TEA, DGA and DIPA).

The framework of the thermodynamic model is based on two types of equilibria: vapour-liquid phase equilibria and liquid-phase chemical equilibria.

Phase Equilibria

The vapour-liquid equilibria of the molecular species is given by:

$$y_i \Phi_i^V P = H_i x_i \gamma_i^L \quad (\text{C.36})$$

where: H_i = Henry's constant

P = system pressure

x_i, y_i = mole fraction of molecular species i in the liquid and gas phase

Φ_i^V = fugacity coefficient on the gas phase

γ_i^L = activity coefficient in the liquid phase

The fugacity coefficient is calculated by the Peng-Robinson equation of state (Peng and Robinson, 1976):

$$P = \frac{RT}{V-b} - \frac{a(T)}{V(V+b) + b(V-b)} \quad (\text{C.37})$$

Where the parameters are obtained from the EQUI-PHASE EQUI90™ program library. The activity coefficient is calculated by the Clegg-Pitzer equation that is described later in this section.

Chemical Equilibria

In case of single amine-H₂S-CO₂-H₂O systems, the important chemical dissociation reactions are as follows:

Chemical Dissociation Reactions	
$\text{Amine}^+ \Leftrightarrow \text{Amine} + \text{H}^+$	(C.38)
$\text{H}_2\text{S} \Leftrightarrow \text{HS}^- + \text{H}^+$	(C.39)
$\text{CO}_2 + \text{H}_2\text{O} \Leftrightarrow \text{HCO}_3^- + \text{H}^+$	(C.40)
$\text{H}_2\text{O} \Leftrightarrow \text{OH}^- + \text{H}^+$	(C.41)
$\text{HCO}_3^- \Leftrightarrow \text{CO}_3^{2-} + \text{H}^+$	(C.42)
$\text{HS}^- \Leftrightarrow \text{S}^{2-} + \text{H}^+$	(C.43)

The chemical equilibrium constants in the acid gas - amine systems play an important role in the prediction of the equilibrium solubilities of acid gases in the aqueous amine solutions. The equilibrium constant K can be expressed by:

$$K = \prod_i (x_i y_i)^{\beta_i} \quad (\text{C.44})$$

The equilibrium constant is expressed as a function of temperature:

$$\ln K = C_1 + C_2/T + C_3 \ln T + C_4 T \quad (\text{C.45})$$

Henry's constant has the same function of temperature as that in equation (C.45). In the liquid phase, there are four molecular species, Amine, H₂O, CO₂, H₂S and seven ionic species, Amine⁺, HCO₃⁻, HS⁻, H⁺, OH⁻, CO₃²⁻, S²⁻ for the amine-H₂S-CO₂-H₂O system. In the gas phase, there are only four molecular species, Amine, H₂O, CO₂ and H₂S.

The determination of the compositions of all molecular and ionic species in both vapour and liquid phases involves the simultaneous solution of a set of non-linear equations that describe the phase equilibria and chemical equilibria, electroneutrality (charge balance) and mass balance of the electrolytes in the aqueous solution.

The Clegg-Pitzer Equation

The original Pitzer equation (Pitzer, 1973) did not consider the solvent molecules in the system as interacting particles. Thus it is not suitable for the thermodynamic description of the mixed-solvent systems. In the Clegg-Pitzer model, all the species in the system were considered as interacting particles. The long-range electrostatic term and the short-range hard-sphere-repulsive term deduced from the McMillan-Mayer's statistical osmotic-pressure theory remained unchanged. The excess Gibbs free energy, g^{ex} consists of the long-range Debye-Huckel electrostatic interaction term, g^{DH} and the short-range Margules expansions with two- and three-suffix, g^s :

$$g^{ex} = g^{DH} + g^s \quad (C.46)$$

$$\frac{g^{DH}}{RT} = \frac{4A_x I_x}{\rho} \ln(1 + \rho I_x^{1/2}) + \sum_c \sum_a x_c x_a B_{ac} g(\alpha I_x^{1/2}) \quad (C.47)$$

$$\frac{g^s}{RT} = \sum_c \sum_a a_{ij} x_i x_j + \sum_i \sum_j \sum_k a_{ijk} x_i x_j x_k \quad (C.48)$$

$$\frac{g^s}{RT} = x_l \sum_n x_n \sum_c \sum_a F_c F_a W_{nca} + \sum_n \sum_{n''} x_n x_{n''} (A_{nn''} x_n + A_{n''n} x_{n''})$$

where: $A_{nn'} = 2a_{nn'} + 3a_{n'n}$

$$A_{nn''} = 2a_{nn''} + 3a_{nn''n''}$$

$$W_{nca} = (2w_{nc} + 2w_{na} - w_{ca} + 2u_{nc} + 2u_{na})/4$$

$$w_{ij} = 2a_{ij} + 3/2(a_{ij} + a_{ij})$$

$$u_{ij} = 3/2(a_{ij} - a_{ij})$$

The expressions of activity coefficient for solvent N and ion M⁺ are as follows:

$$\begin{aligned} \ln \gamma_N = & \frac{2A_x I_x^{3/2}}{1 + \rho I_x^{1/2}} - \sum_c \sum_a x_c x_a B_{ca} \exp(-\alpha I_x^{1/2}) + x_I (1 - x_N) \sum_c \sum_a F_c F_a W_{Nca} \\ & - x_I \sum_n' x_n \sum_c \sum_a F_c F_a W_{nca} + \sum_n' x_n [A_{Nn} x_n (1 - 2x_N) + 2A_{nN} x_N (1 - x_N)] \\ & - 2 \sum_n' \sum_{n'} x_n x_{n'} (A_{nn'} x_{n'} + A_{n'n} x_n) \end{aligned} \quad (\text{C.49})$$

$$\begin{aligned} \ln \gamma_{M^+} = & -z_M^2 A_x \left[\frac{2}{\rho} \ln(1 + \rho I_x^{1/2}) + \frac{I_x^{1/2} (1 - 2I_x/z_M^2)}{1 + \rho I_x^{1/2}} \right] + \sum_a x_a B_{ma} g(\alpha I_x^{1/2}) \\ & - \sum_c \sum_a x_c x_a B_{ca} \left[\frac{z_M^2 g(\alpha I_x^{1/2})}{2I_x} + (1 - z_M^2/2I_x) \exp(-\alpha I_x^{1/2}) \right] + 2 \sum_n x_n \sum_a F_a W_{nMa} \\ & - \sum_n x_n (1 + x_I) \sum_c \sum_a F_c F_a W_{nca} - 2 \sum_a F_a W_{2Ma} + \sum_c \sum_a F_c F_a W_{2ca} \\ & - 2 \sum_n \sum_{n'} x_n x_{n'} (A_{nn'} x_{n'} + A_{n'n} x_n) \end{aligned} \quad (\text{C.50})$$

Where subscripts c, a, n and n' represent cation, anion and molecular species, respectively. The subscript 2 in equation (C.50) stands for water. the total mole fraction of ions (x_I) is given by:

$$x_I = 1 - \sum_n x_n \quad (\text{C.51})$$

The cation and anion fractions F_c and F_a are defined for fully symmetrical electrolyte systems by

$$F_c = 2x_c/x_I \quad (\text{C.52})$$

$$F_a = 2x_a/x_I \quad (\text{C.53})$$

The mole fraction ionic strength I_x is defined as

$$I_x = 1/2 \sum z_i^2 x_i \quad (\text{C.54})$$

The function of $g(x)$ is expressed by

$$g(x) = 2[1 - (1+x)\exp(-x)]/x^2 \quad (\text{C.55})$$

where: $x = \alpha I_x^{1/2} = 2I^{1/2}$

$$I = 1/2 \sum z_i^2 C_i$$

A_x is the Debye-Huckel parameter on a mole fraction basis:

$$A_x = A_\phi \left(\sum C_n \right)^{1/2} \quad (\text{C.56})$$

where: C_i, C_n = molar concentrations of the ion i and solvent n , respectively

I = ionic strength in molar concentration

A_ϕ = Debye-Huckel parameter, which is a function of temperature, density and dielectric constant of the mixed solvents

ρ = related to the hard-core collision diameter, or distance of closest approach between ions in solution

$A_{n'n}$ and $A_{nn'}$ = interaction parameters between and among the molecular species, respectively

B_{ca} = hard sphere repulsion parameter between ions

W_{nca} = the interaction parameter between ions and between ion and solvent

Parameters $A_{n'n}$, A_{nn} , B_{ca} and W_{nca} share the same function of temperature:

$$Y = a + b/T \quad (C.57)$$

The Clegg-Pitzer equations appear to be uncompromisingly long and contain many terms and parameters. However, it should be pointed out that only a few parameters were used and many terms, such as the quaternary terms in the original Clegg-Pitzer equations were omitted in this model. It can be seen that only A_{nn} , $A_{n'n}$, B_{ca} and W_{nca} appear in the expressions and are treated as adjustable parameters.

In this model, both water and amine are treated as solvents. The standard state of each solvent is the pure liquid at the system temperature and pressure. The adopted reference state for ionic and molecular species is the ideal and infinitely dilute aqueous solution.

C.5 Phase Enthalpy

Vapour phase enthalpy is calculated by the Peng-Robinson equation-of-state which integrates ideal gas heat capacity data from a reference temperature. Liquid phase enthalpy also includes the effect of latent heat of vaporization and heat of reaction.

The absorption or desorption of H₂S and CO₂ in aqueous solutions of alkanolamine involves a heat effect due to the chemical reaction. This heat effect is a function of amine type and concentration, and the mole loadings of acid gases. The heat of solution of acid gases is obtained by differentiating the experimental solubility data using a form of the Gibbs-Helmholtz equation.

The heat effect which results from evaporation and condensation of amine and water in both the absorber and regenerator is accounted for through the latent heat term which appears in the calculation of liquid enthalpy. Water content of the sour gas feed can have a dramatic effect on the predicted temperature profile in the absorber and should be considered, particularly at low pressures.

C.6 Simulation of Amine Plant Flowsheets

The key to solving an amine treating system lies in the simulation of the contactor and the regenerator. In both columns, rigorous non-equilibrium stage efficiency calculations are used. In addition, the contactor efficiency incorporates kinetic reaction and mass transfer parameters. Only the Amines Property Package can effectively simulate this system, and only components included in this package should be used.

C.6.1 Solving the Columns

Follow these general guidelines:

- Ensure that the gas to the Contactor is saturated with water.
- Use actual, not ideal, stages.
- Change stage efficiencies for CO₂ and H₂S from their default values of 1.0 to fractions for the regenerator and the initial absorber run.
- Use calculated efficiencies for subsequent absorber runs as detailed below.
- Change the damping factor from a default value of 1.0 to a fraction as recommended in the following section. This may be necessary to prevent oscillation during convergence.

C.6.2 Converging the Contactor

Convergence is most readily achieved by first solving with estimated efficiencies (suggested values are 0.3 for CO₂ and 0.6 for H₂S), then requesting calculated efficiencies and restarting the column. To do this, you must first specify three dimensions for each tray: tray diameter, weir length and weir height. Specify these parameters in the Amines page of the Parameters tab in the Column view.

For an existing column, use the actual dimensions. For a design situation (or when the tray dimensions are unknown) use the Tray Sizing utility to estimate these parameters. Input the calculated tray dimensions and select Run. HYSYS will calculate the individual component efficiencies (H₂S, CO₂) based on the tray dimensions. Only single pass trays can be modeled with the Amines Property Package. If the trays in your column are multipass, you must estimate the dimensions based on a single pass tray.

After the tray dimensions are specified, the column is recalculated. Note that efficiencies can be calculated only when using the Amines Property Package. These values apply specifically to CO₂ and H₂S. Damping factors in the range 0.4 - 0.8 usually give the fastest convergence.

Temperatures around the contactor should be as follows:

Contactor Stream	Temperature Range
Feed Gas	65 - 130 °F
Lean MEA, DEA, TEA, MDEA	100 - 120 °F
Lean DGA	140 °F (lean amine minimum 10 °F > feed gas)
Absorber Bottoms	120 - 160 °F

C.6.3 Converging the Regenerator

As with the Contactor, efficiencies can be either specified by the user, or calculated by the program. For the condenser and reboiler, values of 1.0 must be used. For the remaining trays, efficiencies of 0.15 for CO₂ and 0.80 for H₂S are suggested initial estimates.

The easiest specifications to converge are the stage 1 (condenser) temperature and the reboiler duty. Following is a guideline for typical duties.

Amine	Duty, BTU/US Gallon
TEA, MDEA	800
DEA	1,000
MEA	1,200
DGA	1,300

The reboiler temperature should not exceed 280 F to avoid physical degradation of the amines into corrosive by-products. Regenerators usually converge best with reflux ratio estimates of 0.5 - 3.0 and damping factors of 0.2 - 0.5.

C.6.4 Recycle Convergence

The remaining unit operations in the flowsheet are straightforward. Note that you need a water makeup stream, as indicated in [Figure C.1](#). Since the lean amine concentration may vary due to water carryover in the product from the vessels, a water makeup is required to maintain a desired concentration.

Amine losses in the contactor overhead are usually negligible and the makeup stream replaces any water lost so the amine concentration in the recycle does not change significantly during the recycle convergence. Thus, you can quite easily make an excellent initial estimate for the lean amine recycle. The phase, of course, is liquid and the temperature, pressure, total flow rate and composition are known. Although the composition of CO₂ and H₂S is unknown, these sour components have only a very minor impact on the recycle and can initially be specified to be zero in the recycle stream.

C.6.5 Operating Conditions

The Amines property package contains data for the following alkanolamines and mixtures of alkanolamines.

Amine	HYSYS Name
Monoethanolamine	MEA
Diethanolamine	DEA
Triethanolamine	TEA
Methyldiethanolamine	MDEA
Diglycolamine	DGA
Diisopropanolamine	DIPA
Monoethanolamine/ Methyldiethanolamine Blend	MEA/MDEA
Diethanolamine/ Methyldiethanolamine Blend	DEA/MDEA

Many different amine system designs can be modeled. However, for both good tower convergence and optimum plant operation, the following guidelines are recommended:

Amine	Lean Amine Strength	Maximum Acid Gas Loading (Moles Acid Gas/ Mole Amine)	
		CO ₂	H ₂ S
	Weight %		
MEA	15 - 20	0.50	0.35
DEA	25 - 35	0.45	0.30
TEA, MDEA	35 - 50	0.30	0.20
DGA	45 - 65	0.50	0.35
DEA/MDEA*	35 - 50	0.45	0.30
MEA/MDEA*	35 - 50	0.45	0.30

* Amine mixtures are assumed to be primarily MDEA.

C.7 Program Limitations

The Amines property package contains correlations of data which restrict its use to certain conditions of pressure, temperature and composition. These limitations are given below.

The chemical and physical property data base is restricted to amines and the following components:

Available Components with Amines Property Package	
Acid Gases	CO ₂ , H ₂ S, COS, CS ₂
Hydrocarbons	CH ₄ to C ₁₂
Olefins	C ₂ =, C ₃ =, C ₄ =, C ₅ =
Mercaptans	M-Mercaptan, E-Mercaptan
Non-Hydrocarbons	H ₂ , N ₂ , O ₂ , CO, H ₂ O
Aromatic	C ₆ H ₆ , Toluene, e-C ₆ h ₆ , m-Xylene

This method does not allow for the use of any hypotheticals.

C.7.1 Range of Applicability

The following table displays the equilibrium solubility limitations that should be observed when using this property package.

Amine	Alkanolamine Concentration	Acid Gas Partial Pressure	Temperature
	Range (Wt%)	psia	°F
MEA	0 - 30	0.00001 - 300	77 - 260
DEA	0 - 50	0.00001 - 300	77 - 260
TEA	0 - 50	0.00001 - 300	77 - 260
MDEA	0 - 50	0.00001 - 300	77 - 260
DGA	50 - 70	0.00001 - 300	77 - 260
DIPA	0 - 40	0.00001 - 300	77 - 260

For amine mixtures, use the values for MDEA (assumed to be the primary amine).

C.8 References

- ¹ Atwood, K., M.R. Arnold and R.C. Kindrick, "Equilibria for the System, Ethanolamines-Hydrogen Sulfide-Water", *Ind. Eng. Chem.*, 49, 1439-1444, 1957.
- ² Austgen, D.M., G.T. Rochelle and C.-C. Chen, "Model of Vapour-Liquid Equilibria for Aqueous Acid Gas Alkanolamine Systems", *Ind. Eng. Chem. Res.*, 03, 543-555, 1991.
- ³ Bosch, H., "Gas-Liquid Mass Transfer with Parallel Reversible Reactions-III. Absorption of CO₂ into Solutions of Blends of Amines", *Chem. Eng. Sci.*, 44, 2745-2750, 1989.
- ⁴ Chakravarty, T., "Solubility Calculations for Acid Gases in Amine Blends", Ph.D. Dissertation, Clarkson College, Potsdam, NY, 1985.
- ⁵ Danckwerts, P.V., and M.M. Sharma, "The Absorption of Carbon Dioxide into Solutions of Alkalis and Amines", *The Chemical Engineer*, No.202, CE244-CE279, 1966.
- ⁶ Deshmukh, R.D. and A.E. Mather, "A Mathematical Model for Equilibrium Solubility of Hydrogen Sulfide and Carbon Dioxide in Aqueous Alkanolamine Solutions",
⁷ *Chem. Eng. Sci.*, 36, 355-362, 1981.
- ⁸ Dingman, J.C., "How Acid Gas Loadings Affect Physical Properties of MEA Solutions", *Pet. Refiner*, 42, No.9, 189-191, 1963.
- ⁹ Dow Chemical Company, "Alkanolamines Handbook", Dow Chemical International, 1964.
- ¹⁰ Isaacs, E.E., F.D. Otto and A.E. Mather, "Solubility of Mixtures of H₂S and CO₂ in a Monoethanolamine Solution at Low Partial Pressures", *J. Chem. Eng. Data*, 25, 118-120, 1980.
- ¹¹ Jou, F.-Y., A.E. Mather, and F.D. Otto, "Solubility of H₂S and CO₂ in Aqueous Methyl-diethanolamine Solutions", *Ind. Eng. Chem. Process Des. Dev.*, 21, 539-544, 1982.

- ¹²Jou, F.-Y., F.D. Otto and A.E. Mather, "Solubility of H₂S and CO₂ in Triethanolamine Solutions", Presented at the AIChE Winter National Meeting, Atlanta, Georgia, March 11-14, 1984.
- ¹³Jou, F.-Y., F.D. Otto and A.E. Mather, "Solubility of Mixtures of H₂S and CO₂ in a Methyl-diethanolamine Solution", Paper 140b, Presented at the AIChE Annual Meeting, Miami Beach, Florida, Nov.2-7, 1986.
- ¹⁴Jou, F.-Y., A.E. Mather and F.D. Otto, "The Solubility of Mixtures of Hydrogen Sulfide and Carbon Dioxide in Aqueous Methyl-diethanolamine Solutions", Submitted to The Canadian Journal of Chemical Engineering, 1992.
- ¹⁵Kahrim, A. and A.E. Mather, "Enthalpy of Solution of Acid Gases in DEA Solutions", Presented at the 69th AIChE Annual Meeting, Chicago, Illinois, Nov.28-Dec.2, 1976.
- ¹⁶Katz, D.L., D. Cornell, R. Kobayashi, F.H. Poettmann, J.A. Vary, J.R. Elenbaas and C.F. Weinaug, "Handbook of Natural Gas Engineering", McGraw-Hill, New York, 1959.
- ¹⁷Kent, R.L., and B. Eisenberg, "Better Data for Amine Treating", Hydrocarbon Processing, 55, No.2, 87-90, 1976.
- ¹⁸Kohl, A.L. and F.C. Riesenfeld, "Gas Purification", 4th Ed., Gulf Publishing Co., Houston, Texas, 1985.
- ¹⁹Lal, D., E.E. Isaacs, A.E. Mather and F.D. Otto, "Equilibrium Solubility of Acid Gases in Diethanolamine and Monoethanolamine Solutions at Low Partial Pressures", Proceedings of the 30th Annual Gas Conditioning Conference, Norman, Oklahoma, March 3-5, 1980.
- ²⁰Lawson, J.D., and A.W. Garst, "Gas Sweetening Data: Equilibrium Solubility of Hydrogen Sulfide and Carbon Dioxide in Aqueous Monoethanolamine and Aqueous Diethanolamine Solutions", J. Chem. Eng. Data, 21, 20-30, 1976.
- ²¹Lawson, J.D., and A.W. Garst, "Hydrocarbon Gas Solubility in Sweetening Solutions: Methane and Ethane in Aqueous Monoethanolamine and Diethanolamine", J. Chem Eng. Data, 21, 30-32, 1976.
- ²²Lee, J.I., F.D. Otto, and A.E. Mather, "Solubility of Carbon Dioxide in Aqueous Diethanolamine Solutions at High Pressures", J. Chem. Eng. Data, 17, 465-468, 1972.
- ²³Lee, J.I., F.D. Otto, and A.E. Mather, "Solubility of Hydrogen Sulfide in Aqueous Diethanolamine Solutions at High Pressures", J. Chem. Eng. Data, 18, 71-73, 1973a.
- ²⁴Lee, J.I., F.D. Otto, and A.E. Mather, "Partial Pressures of Hydrogen Sulfide over Aqueous Diethanolamine Solutions", J. Chem. Eng. Data, 18, 420, 1973b.

- ²⁵ Lee, J.I., F.D. Otto, and A.E. Mather, "The Solubility of Mixtures of Carbon Dioxide and Hydrogen Sulphide in Aqueous Diethanolamine Solutions", *Can. J. Chem. Eng.*, 52, 125-127, 1974a.
- ²⁶ Lee, J.I., F.D. Otto and A.E. Mather, "The Solubility of H₂S and CO₂ in Aqueous Monoethanolamine Solutions", *Can. J. Chem. Eng.*, 52, 803-805, 1974b.
- ²⁷ Lee, J.I., F.D. Otto and A.E. Mather, "Solubility of Mixtures of Carbon Dioxide and Hydrogen Sulfide in 5.0 N Monoethanolamine Solution", *J. Chem. Eng. Data*, 20, 161-163, 1975.
- ²⁸ Lee, J.I., F.D. Otto and A.E. Mather, "Equilibrium in Hydrogen Sulfide-Monoethanolamine-Water System", *J. Chem. Eng. Data*, 21, 207-208, 1976a.
- ²⁹ Lee, J.I., F.D. Otto and A.E. Mather, "The Measurement and Prediction of the Solubility of Mixtures of Carbon Dioxide and Hydrogen Sulphide in a 2.5 N Monoethanolamine Solution", *Can. J. Chem. Eng.*, 54, 214-219, 1976b.
- ³⁰ Lee, J.I., F.D. Otto and A.E. Mather, "Equilibrium Between Carbon Dioxide and Aqueous Monoethanolamine Solutions", *J. Appl. Chem. Biotechnol.*, 26, 541-549, 1976c.
- ³¹ Lee, J.I. and A.E. Mather, "Solubility of Hydrogen Sulfide in Water", *Ber. Bunsenges z. Phys. Chem.*, 81, 1020-1023, 1977.
- ³² Mason, D.M. and R.Kao, "Correlation of Vapor-Liquid Equilibria of Aqueous Condensates from Coal Processing" in *Thermodynamics of Aqueous Systems with Industrial Applications*, S.A. Newman, ed., ACS Symp. Ser., 133, 107-139, 1980.
- ³³ Murzin, V.I., and I.L. Leites, "Partial Pressure of Carbon Dioxide Over Its Dilute Solutions in Aqueous Aminoethanol", *Russian J. Phys. Chem.*, 45, 230-231, 1971.
- ³⁴ Nasir, P. and A.E. Mather, "The Measurement and Prediction of the Solubility of Acid Gases in Monoethanolamine Solutions at Low Partial Pressures", *Can. J. Chem. Eng.*, 55, 715-717, 1977.
- ³⁵ Otto, F.D., A.E. Mather, F.-Y. Jou, and D. Lal, "Solubility of Light Hydrocarbons in Gas Treating Solutions", Presented at the AIChE Annual Meeting, Paper 21b, San Francisco, California, November 25-30, 1984.
- ³⁶ Peng, D.-Y., and D.B. Robinson, "A New Two-Constant Equation of State", *Ind. Eng. Chem. Fundam.*, 15, 59-64, 1976.
- ³⁷ Rangwala, H.A., B.R. Morrell, A.E. Mather and F.D. Otto, "Absorption of CO₂ into Aqueous Tertiary Amine/MEA Solutions", *The Canadian Journal of Chemical Engineering*, 70, 482-490, 1992.

- ⁴⁰Tomcej, R.A. and F.D. Otto, "Computer Simulation and Design of Amine Treating Units", Presented at the 32nd Canadian Chemical Engineering Conference, Vancouver, British Columbia, Oct.3-6, 1982.
- ⁴¹Tomcej, R.A., F.D. Otto and F.W. Nolte, "Computer Simulation of Amine Treating Units", Presented at the 33rd Annual Gas Conditioning Conference, Norman,
- ⁴²Oklahoma, March 7-9, 1983.
- ⁴³Tomcej, R.A., "Simulation of Amine Treating Units Using Personal Computers", Presented at the 35th Canadian Chemical Engineering Conference, Calgary, Alberta, Oct.5-8, 1985.
- ⁴⁴Tomcej, R.A. and F.D. Otto, "Improved Design of Amine Treating Units by Simulation using Personal Computers", Presented at the World Congress III of Chemical Engineering, Tokyo, Japan, September 21-25, 1986.
- ⁴⁵Tomcej, R.A., D. Lal, H.A. Rangwala and F.D. Otto, "Absorption of Carbon Dioxide into Aqueous Solutions of Methyl-diethanolamine", Presented at the AIChE Annual Meeting, Miami Beach, Florida, Nov.2-7, 1986.
- ⁴⁶Tomcej, R.A., F.D. Otto, H.A. Rangwala and B.R. Morrell, "Tray Design for Selective Absorption", Presented at the 37th Annual Laurance Reid Gas Conditioning Conference, Norman, Oklahoma, March 2-4, 1987.
- ⁴⁷Union Carbide Corporation, "Gas Treating Chemicals", Union Carbide Petroleum Processing, Chemicals and Additives, 1969.
- ⁴⁸Versteeg, G.F., J.A.M. Kuipers, F.P.H. Van Beckum and W.P.M. Van Swaaij, "Mass Transfer with Complex Reversible Chemical Reactions - I. Single Reversible Chemical Reaction", Chem. Eng. Sci., 44, 2295-2310, 1989.
- ⁴⁹Winkelman, J.G.M., S.J. Brodsky and A.A.C.M. Beenackers, "Effects of Unequal Diffusivities on Enhancement Factors of Reversible Reactions: Numerical Solutions and Comparison with Decoursey's Method", Chem. Eng. Sci., 47, 485-489, 1992.
- ⁵⁰Zhang, Dan D., Gordon X. Zhao, H.-J. Ng, Y.-G. Li and X.-C. Zhao, "An Electrolyte Model for Amine Based Gas Sweetening Process Simulation", Preceding of the 78th GPA Annual Convention, p25, 1999.
- ⁵¹Zhang, Dan D., H.-J. Ng and Ray Vledman, "Modeling of Acid Gas Treating Using AGR Physical Solvent", Proceeding of the 78th GPA Annual Convention, p62, 1999.

A

- Activity Models 2-9, A-6, A-16
 - See *models* - Chien Null, Margules, NRTL, NRTL Options, UNIQUAC, van Laar, and Wilson
 - additional specifications 2-17, 2-82
 - binary interaction parameters 2-38, 2-86
 - choosing vapour phase model 2-17, A-19, A-35
 - departure calculations A-47
 - estimating interaction parameters 2-39
 - immiscible liquid phases A-21
- Amines Property Package 2-12, A-41
- Antoine
 - modified vapour pressure model A-39
 - parameters tab 2-31
 - vapour pressure model 2-11, 2-75
- ASME Steam A-43
 - property package 2-12
- Assay and Blend Association 4-74
- Assay Data
 - general guidelines 4-32
 - no distillation data available 4-28, 4-31
 - physical properties 4-26
 - standard input 4-29
- Assays
 - characterizing 4-13, 4-16
 - correlations 4-48
 - inputting 4-19
 - light ends 4-33
 - analysis B-4
 - auto calculating 4-37, B-6
 - included 4-34
 - inputting 4-36
 - light ends free 4-35
 - notes 4-50
 - plotting 4-47
 - selecting 4-52
 - types of 4-46
 - user curves 4-49
 - working curves 4-46
- ASTM D1160. See Laboratory Assay Procedures
- ASTM D2887. See Laboratory Assay Procedures
- ASTM D86. See Laboratory Assay Procedures
- Auto Cut 4-55

B

- Basis Manager
 - component maps tab 6-2

- fluid package tab 2-3
- hypotheticals tab 3-4
- oil manager tab 4-9
- reactions tab 5-3
- user properties tab 7-3

Blends

- auto cutting 4-55
 - bulk data 4-53
 - composite plots 4-64
 - correlations 4-59
 - cut ranges 4-53
 - distribution plots 4-63
 - information 4-60
 - notes 4-66
 - oil distributions 4-61
 - plots summary 4-65
 - property plots 4-61
- Braun K10 2-11, 2-75, A-40
 - Bubble Point A-67
 - Bulk Properties 4-26
 - BWR Equation A-11

C

- Cavett Correlation A-47
- Chao Seader A-6, A-37
 - models 2-11, 2-75
 - parameters tab 2-31
 - semi-empirical method 2-11, 2-76
- Chien Null A-18, A-21
 - activity model 2-10
 - parameters tab 2-28, 2-82
- Chromatographic Analysis. See Laboratory Assay Procedures
- Chromatographic Assay Input 4-29
- Coal Analysis 3-34
- Collection (Component Maps) 6-2
- Component List Selection 2-12, 2-80
- Component Selection 1-12
 - family filter 1-11
 - family type filter 1-11
 - filter options 1-11
 - general procedure 1-8
 - property package filter 1-11
 - tips 1-8
 - warning messages 2-13
- Components
 - adding 1-5
 - cloning. See Hypotheticals, cloning library components

- creating custom. See Hypotheticals, adding
- filtering 1-9
- hypotheticals quick access 1-26
- incompatible 2-14
- manager 1-2
- mapping 6-2
- master component list 1-2
- name format 1-7, 1-9
- non recommended 2-13
- parameters tab 2-20, 2-82
- removing 1-6, 1-13
- selected components group 1-6
- selection 1-8, 1-12
- sorting 1-7, 1-14
- substituting 1-6, 1-14
- synonyms 1-8
- transferring 1-12
- viewing 1-7, 1-15
- Components Manager 1-2
- Conversion Reactions 5-6–5-10
 - rank 5-37
- Correlations
 - assay 4-48
 - blend 4-59
 - critical property B-9
 - oil characterization 4-70
- Cut 4-53
- Cut/Blend. See Blends or Oil Characterization
- Cutpoint B-7

D

- D86 Interconversion Methods 4-15
- D86. See Laboratory Assay Procedures
- Density. See Liquid Density or Vapour Density
- Dew Point A-67

E

- EFV (Equilibrium Flash Vapourization). See Laboratory Assay Procedures
- Eley-Rideal Model 5-23
- Enthalpy Basis A-45
 - tabular 2-61
- Enthalpy Departure Calculations A-45
- Enthalpy Flash A-68
- Entropy Flash A-68
- Environments
 - basis 4-vi
- Equations of State (EOS) 2-8, A-9
 - additional information 2-15, 2-81

- departure calculation A-45
- interaction parameters 2-37, 2-84
- See *models* - Generalized Cubic (GCEOS), Kabadi Danner, Lee-Kesler Plocker, Peng Robinson, PRSV, Peng Robinson Options, SRK, SRK Options, Zudkevitch Joffee.

- Equations of State Enthalpy Calculation A-15
- Equilibrium Reactions 5-6, 5-11–5-17
 - fractional approach 5-16
 - temperature approach 5-16
- Esso Tabular A-40
 - vapour pressure model 2-11, 2-75
- Extended NRTL. See NRTL Options

F

- Flash Calculations A-65
 - handling water A-69
 - temperature-pressure (TP) A-65
 - vapour fraction A-66
- Flow Rate
 - actual gas A-64
 - actual volume A-63
 - as a specification A-64
 - available A-59
 - densities, liquid and vapour A-60
 - liquid volume A-63
 - mass A-62
 - molar A-62
 - standard gas A-63
 - standard liquid volume A-63
 - volumetric A-59
- Fluid Package
 - activity models 2-9
 - adding 2-3
 - adding - quick start 2-4
 - adding notes 2-69
 - advantages 2-2
 - associated flowsheet 2-4
 - base property selection 2-8
 - copy 2-3
 - delete 2-3
 - equations of state 2-8
 - export 2-3
 - import 2-3
 - property package selection 2-7
 - property view 2-7, 2-70
 - reactions 2-46
 - stability test 2-42, 2-89

- tabular 2-47
 - See *also* Tabular Package
- Fugacity Coefficients A-51
- G**
- General NRTL. See NRTL Options
- Generalized Cubic Equation of State (GCEOS) 2-9
 - binary coeffs tab 2-32
 - parameters tab 2-21
- Grayson Streed A-6, A-37
 - parameters tab 2-31
 - semi-empirical method 2-11, 2-76
- H**
- Henry's Law A-32
- Heterogeneous Catalytic Reactions 5-6, 5-23–5-28
 - Eley-Rideal 5-23
 - Langmuir-Hinshelwood 5-23
 - Mars-van Krevelen Model 5-23
- Hypothetical Components. See Hypotheticals
- Hypothetical Group
 - controls 3-12
 - creating 3-4, 3-11
 - deleting 3-4
 - exporting 3-4
 - group name 3-12
 - importing 3-4
 - moving 3-40
 - moving between 3-5
 - viewing 3-4, 3-39
- Hypotheticals
 - adding 1-26, 3-13
 - adding a hypothetical - quick start 3-5
 - adding hypothetical group 1-26
 - base properties 3-14
 - cloning library components 3-5, 3-13, 3-37
 - critical properties 3-25
 - deleting 3-13
 - estimating properties 3-13, 3-26
 - estimation methods 3-12, 3-16
 - individual controls 3-13
 - minimum information required 3-16
 - moving 3-5
 - property view 3-23
 - quick reference 3-5
 - solid hypotheticals 3-13, 3-32
 - temperature dependent properties 3-29
 - UNIFAC structure builder 3-13, 3-20
 - vapour pressure properties 3-15
 - viewing 3-5, 3-13
 - viewing group. See Hypothetical Group, viewing
- I**
- Ideal Gas Law A-35
 - departure calculations A-48
- Installing
 - oils 4-13
 - reaction set 5-39
- Interaction Parameters
 - activity models 2-38, 2-86, A-19
 - equations of state 2-37, 2-84
 - estimating A-16
 - Henry's Law A-34
- K**
- K/ln(K) Equilibrium Constant 5-14
- Kabadi Danner A-9, A-11
 - equation of state 2-9
 - parameters tab 2-27
- Kinetic Reactions 5-18–5-23
 - requirements 5-6
- L**
- Laboratory Assay Procedures
 - ASTM D1160 4-6, 4-28
 - ASTM D2887 4-6, 4-28
 - ASTM D86 4-6, 4-28
 - ASTM D86 and D1160 4-28
 - chromatographic analysis 4-6, 4-28
 - assay input 4-29
 - D2887 interconversion method 4-15
 - D86 interconversion method 4-15
 - equilibrium flash vapourization 4-6, 4-28
 - preparation 4-34
 - TBP analysis 4-5, 4-28
- Langmuir-Hinshelwood Model 5-23
- Lee Kesler Plocker 2-9, A-9, A-11
- Lee-Kesler Enthalpy A-15, A-37, A-49
- Liquid Density A-52
 - actual A-61
 - ideal A-61
 - standard A-61
- M**
- Mapping
 - collection 6-2
 - components 6-1

- target 6-2
 - transfer options 6-5
 - Margules A-18, A-26
 - activity model 2-10
 - Mars-van Krevelen Model 5-23
 - MBWR A-43
 - property package 2-12
- N**
- NBS Steam A-43
 - property package 2-12
 - NRTL (Non Random Two Liquid) A-18, A-21, A-27
 - activity model 2-10
 - NRTL Options A-21
 - Extended NRTL 2-10, A-24
 - General NRTL 2-10, A-24

O

- Oil Characterization
 - analysis methods. *See* Laboratory Assay Procedures
 - bulk blending data 4-53
 - component critical properties B-8
 - composite plots 4-64
 - correlations 4-8, 4-13, 4-48, 4-70
 - cutting/blending 4-13, 4-51
 - deleting 4-14
 - density curves 4-40
 - determining TBP cutpoints B-7
 - distribution plots 4-63
 - FBP 4-14
 - IBP 4-14
 - installing oil 4-75
 - laboratory data corrections 4-8
 - light ends 4-33–4-34, 4-36, B-4
 - method B-2
 - molecular weight curves 4-39
 - notes 4-74
 - output settings 4-14
 - physical property curves 4-7, 4-29
 - procedure 4-9
 - property plots 4-61
 - property view 4-13
 - purpose 4-3
 - user properties 4-13, 4-66
 - viscosity curves 4-41
 - working curves 4-46

P

- Peng Robinson A-5–A-6, A-9
 - departure calculations A-45
 - equation of state 2-9
 - fugacity coefficient A-51
 - modelling vapour phase A-35
- Peng Robinson Options A-9
 - PRSV 2-9
 - Sour PR 2-9, A-14
- Physical Properties A-51
- Poynting Correction 2-18, A-19
- PPDS 2-56–2-57
- Property Package
 - selecting a A-4
- Property Packages
 - See* Amines Property Package, Braun K10, Chao Seader, Esso Tabular, Grayson Streed, Lee Kesler Plocker, Margules, MBWR, PRSV, Peng Robinson, Peng Robinson Options, SRK, SRK Options, Steam Packages, UNIQUAC, van Laar and Wilson.
- PRSV (Peng Robinson Stryjek Vera) A-5, A-12
 - equation of state 2-9
 - parameters tab 2-28
- Pseudo Component Generation 4-51

Q

- Quality Pressure A-67

R

- Reaction Package
 - adding 5-40
- Reaction Rank 5-37
- Reaction Sets 5-32
 - adding 5-33
 - adding to fluid package 5-33, 5-39
 - advanced features 5-35
 - attaching to unit operations 5-39
 - copying 5-33
 - deleting 5-33
 - exporting 5-33, 5-38
 - importing 5-33, 5-38
 - quick access 2-46
 - solver method 5-34
 - viewing 5-33
- Reactions
 - activating 5-34

- adding 5-7
- components 5-3–5-4
- conversion. *See* Conversion Reactions
- copying 5-7
- deactivating 5-34
- deleting 5-7
- equilibrium. *See* Equilibrium Reactions
- heterogeneous catalytic. *See* Heterogeneous Catalytic Reactions
- kinetic. *See* Kinetic Reactions
- library reactions 5-5
- quick start 5-42
- selecting components 5-3–5-4
- sets. *See* Reaction Sets
- simple rate. *See* Simple Rate Reactions
- thermodynamic consistency 5-19
- viewing 5-7

Redlich Kwong (RK) A-35

- departure calculations A-48

S

Simple Rate Reactions 5-29–5-32

- requirements 5-6

Solids A-72

Sour PR. *See* Peng Robinson Options

Sour SRK. *See* SRK Options

Sour Water Options A-14

- See* SRK Options and Peng Robinson Options

SRK (Soave Redlich Kwong) A-5–A-6, A-9

- departure calculations A-46
- equation of state 2-9
- fugacity coefficient A-51
- modelling vapour phase A-35

SRK Options A-9

- See* Kabadi Danner and Zudkevitch Joffe
- Sour SRK 2-9, A-14

Stability Test 2-40, 2-87

- parameters 2-42, 2-89

Steam Packages A-43

- See* ASME Steam and NBS Steam

Stream Information A-73

Surface Tension A-58

T

Tabular Package 2-47

- active properties selection 2-53
- data 2-54
- enthalpy basis 2-61
- library 2-56–2-57

- plotting 2-58
- regression 2-62
- requirements 2-48
- supplying data 2-61
- using 2-50
- viewing selection 2-57

Target (Component Maps) 6-2

Thermal Conductivity A-56

Transport Properties A-51

U

UNIFAC LLE

- interaction parameter estimation 2-39

UNIFAC Property Estimation A-20

UNIFAC Structure Builder 3-20

UNIFAC VLE

- interaction parameter estimation 2-39

UNIQUAC (Universal Quasi Chemical Parameters) 2-10, A-18, A-28

User Points 4-56

User Properties 4-49, 4-66, 7-2–7-9

- adding 7-3
- deleting 7-3
- mixing rules 7-7
- notes 7-9
- viewing 7-3

User Ranges 4-57

V

van Laar A-18, A-30

- activity model 2-10

Vapour Density A-53

Vapour Pressure A-67

Vapour Pressure Models 2-11, A-7, A-38

- Antoine 2-11, 2-75
- Braun K10 2-11, 2-75
- Esso Tabular 2-11, 2-75

Virial Equation A-19

- departure calculations A-48
- modelling vapour phase A-36

Viscosity A-53

- liquid phase mixing rules A-55

W

Water A-69

Wilson 2-10, A-18, A-31

- parameters tab 2-30

Working Curves B-3

Z

Zudkevitch Joffe A-9, A-15
equation of state 2-9
parameters tab 2-28